



|   |  |   |   |  |   |
|---|--|---|---|--|---|
| <b>Prüfbericht-Nr.:</b><br><i>Test Report No.:</i>  | <b>50336830 001</b>  | <b>Auftrags-Nr.:</b><br><i>Order No.:</i>   | <b>244183328</b>  | Seite 1 von 5<br>Page 1 of 5                     |   |
| <b>Kunden-Referenz-Nr.:</b><br><i>Client Reference No.:</i>   | <b>60125218</b>  | <b>Auftragsdatum:</b><br><i>Order date:</i>   | <b>04.11.2019</b>   |  |   |
| <b>Auftraggeber:</b><br><i>Client:</i>  | <b>Zhejiang Envertech Corporation Ltd</b><br>24th Floor, Jintong Mansion, Center of Headquarters, Huangtang Block, DongCheng district, Yongkang City, Zhejiang Province 321300, P.R. China   |   |   |  |   |
| <b>Prüfgegenstand:</b><br><i>Test item:</i>   | <b>Grid Connected PV Inverter</b>  |   |   |  |   |
| <b>Bezeichnung / Typ-Nr.:</b><br><i>Identification / Type No.:</i>  | <b>EVT300, EVT360, EVT560, EVT600, EVT660, EVT720, EVT1200</b>   |   |   |  |   |
| <b>Auftrags-Inhalt:</b><br><i>Order content:</i>  | <b>AK certificate</b>  |   |   |  |   |
| <b>Prüfgrundlage:</b><br><i>Test specification:</i>   | <b>VDE-AR-N 4105/11.18</b><br><br><i>Erzeugungsanlagen am Niederspannungsnetz –<br/>Technische Mindestanforderungen für Anschluss und Parallelbetrieb von<br/>Erzeugungsanlagen am Niederspannungsnetz</i><br><br><i>Generators connected to the low-voltage distribution network –<br/>Technical requirements for the connection to and parallel operation with low-voltage<br/>distribution networks</i> |   |   |  |   |
| <b>Wareneingangsdatum:</b><br><i>Date of receipt:</i>   | <b>04.11.2019</b>  |   |   |  |   |
| <b>Prüfmuster-Nr.:</b><br><i>Test sample No.:</i>   | <b>A001059840-001</b>  |   |   |  |   |
| <b>Prüfzeitraum:</b><br><i>Testing period:</i>  | <b>04.11.2019 – 15.01.2020</b>   |   |   |  |   |
| <b>Ort der Prüfung:</b><br><i>Place of testing:</i>   | <b>TÜV Rheinland (Shanghai)<br/>Co., Ltd.</b>  |   |   |  |   |
| <b>Prüflaboratorium:</b><br><i>Testing laboratory:</i>  | <b>TÜV Rheinland (Shanghai)<br/>Co., Ltd.</b>  |   |   |  |   |
| <b>Prüfergebnis*:</b><br><i>Test result*:</i>   | <b>Pass</b>  |   |   |  |   |
| <b>geprüft von / tested by:</b>   |  |   | <b>kontrolliert von / reviewed by:</b>  |  |   |
| 17.01.2020  | Tobias Yang / PE   |  | 17.01.2020  | Yin Yue / TC                                     |  |
| <b>Datum</b><br><i>Date</i>   | <b>Name / Stellung</b><br><i>Name / Position</i>   | <b>Unterschrift</b><br><i>Signature</i>   | <b>Datum</b><br><i>Date</i>   | <b>Name / Stellung</b><br><i>Name / Position</i> | <b>Unterschrift</b><br><i>Signature</i>   |
| <b>Sonstiges / Other:</b> Test procedure complied with E DIN VDE V 0124-100/09.19, see report 50336830 001 attachment 1 for detail.   |  |   |   |  |   |
| <b>Zustand des Prüfgegenstandes bei Anlieferung:</b><br><i>Condition of the test item at delivery:</i>  |  |   | <b>Prüfmuster vollständig und unbeschädigt</b><br><i>Test item complete and undamaged</i> |  |   |
| * Legende: 1 = sehr gut    2 = gut    3 = befriedigend    4 = ausreichend    5 = mangelhaft<br>P(ass) = entspricht o.g. Prüfgrundlage(n)    F(ail) = entspricht nicht o.g. Prüfgrundlage(n)    N/A = nicht anwendbar    N/T = nicht getestet<br>Legend: 1 = very good    2 = good    3 = satisfactory    4 = sufficient    5 = poor<br>P(ass) = passed a.m. test specification(s)    F(ail) = failed a.m. test specification(s)    N/A = not applicable    N/T = not tested |  |   |   |  |   |
| <b>Dieser Prüfbericht bezieht sich nur auf das o.g. Prüfmuster und darf ohne Genehmigung der Prüfstelle nicht auszugsweise vervielfältigt werden. Dieser Bericht berechtigt nicht zur Verwendung eines Prüfzeichens.</b><br><i>This test report only relates to the a. m. test sample. Without permission of the test center this test report is not permitted to be duplicated in extracts. This test report does not entitle to carry any test mark.</i>                  |  |   |   |  |   |
| TUV Rheinland LGA Products GmbH · Tillystraße 2 · D - 90431 Nürnberg · Tel.: +49 911 655 5225 · Fax: +49 911 655 5226<br>Mail: service@de.tuv.com · Web: www.tuv.com  |  |   |   |  |   |





**Prüfbericht-Nr.: 50336830 001**  
*Test Report No.: 50336830 001*

Seite 3 von 5  
Page 3 of 5

**Produktbeschreibung**  
*Product description*

|          |  |   |
|----------|--|---|
| <b>1</b> | <b>Produktdetails</b><br><i>Product details</i>                | See test report 50336830 001 Attachment 1 |
| <b>2</b> | <b>Maße / Gewicht</b><br><i>Dimensions / Weight</i>            | Same as above.                            |
| <b>3</b> | <b>Bedienelemente</b><br><i>Operating elements</i>             | Same as above.                            |
| <b>4</b> | <b>Ausstattung / Zubehör</b><br><i>Equipment / Accessories</i> | Same as above.                            |
| <b>5</b> | <b>Verwendete Materialien</b><br><i>Used materials</i>         | Same as above.                            |
| <b>6</b> | <b>Sonstiges</b><br><i>Other</i>                               | Same as above.                            |
|          |  |   |
|          |  |   |
|          |  |   |

**Prüfbericht-Nr.: 50336830 001**  
*Test Report No.: 50336830 001*

Seite 4 von 5  
 Page 4 of 5

| Absatz | Anforderungen - Prüfungen   | Messergebnisse - Bemerkungen       | Bewertung         |
|--------|-----------------------------|------------------------------------|-------------------|
| Clause | <i>Requirements - Tests</i> | <i>Measuring results - Remarks</i> | <i>Evaluation</i> |

|   |   |  |  |
|---|---|--|--|
| 1 | <p><b>Anwendungsbereich</b><br/> <b>Scope</b></p> <p><i>Details zur Ausgestaltung der messtechnischen Nachweise und zur Dokumentation der Messergebnisse sind in E DIN VDE-V 0124-100 (VDE V 0124-100):2019-09 beschrieben.</i></p> <p><b><i>Details on the design of the measuring certificates and the documentation of the measurement results are described in E DIN VDE-V 0124-100 (VDE V 0124-100):2019-09.</i></b></p> |  |  |
|---|---|--|--|



**ANLAGE zum Prüfbericht-Nr.: 50336830 001**  
*APPENDIX to Test Report No.: 50336830 001*

Seite 5 von 5  
Page 5 of 5

**ZUSATZ-DOKUMENTATION**  
***ADDITIONAL DOCUMENTATION***

1. E DIN VDE V 0124-100/09.19 measurement 50336830 001 attachment 1
2. Photo documentations

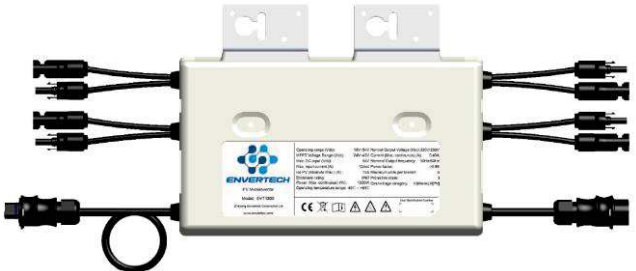
|  |   |  |                                 |  |   |
|--|---|--|---------------------------------|--|---|
| <b>Prüfbericht-Nr.:</b><br><i>Test Report No.:</i>   | 50336830 001 Attachment 1   | <b>Auftrags-Nr.:</b><br><i>Order No.:</i>  | See test report<br>50336830 001 | Seite 1 von 34<br>Page 1 of 34                   |   |
| <b>Kunden-Referenz-Nr.:</b><br><i>Client Reference No.:</i>  | See test report 50336830 001  | <b>Auftragsdatum:</b><br><i>Order date:</i>  | See test report 50336830 001    |  |   |
| <b>Auftraggeber:</b><br><i>Client:</i>   | See test report 50336830 001  |  |                                 |  |   |
| <b>Prüfgegenstand:</b><br><i>Test item:</i>  | See test report 50336830 001  |  |                                 |  |   |
| <b>Bezeichnung / Typ-Nr.:</b><br><i>Identification / Type No.:</i>   | See test report 50336830 001  |  |                                 |  |   |
| <b>Auftrags-Inhalt:</b><br><i>Order content:</i>   | AK certificate  |  |                                 |  |   |
| <b>Prüfgrundlage:</b><br><i>Test specification:</i>  | <p>E DIN VDE V 0124-100/09.19</p> <p><i>Netzintegration von Erzeugungsanlagen –Niederspannung –Prüfanforderungen an Erzeugungseinheiten vorgesehen zum Anschluss und Parallelbetrieb am Niederspannungsnetz</i></p> <p><i>Grid integration of generator plants – Low-voltage – Test requirements for generator units to be connected to and operated in parallel with low-voltage distribution networks</i></p> |  |                                 |  |   |
| <b>Wareneingangsdatum:</b><br><i>Date of receipt:</i>  | 04.11.2019  |  |                                 |  |   |
| <b>Prüfmuster-Nr.:</b><br><i>Test sample No.:</i>  | A001059840-001  |  |                                 |  |   |
| <b>Prüfzeitraum:</b><br><i>Testing period:</i>   | 04.11.2019 – 15.01.2020   |  |                                 |  |   |
| <b>Ort der Prüfung:</b><br><i>Place of testing:</i>  | TÜV Rheinland (Shanghai)<br>Co., Ltd.   |  |                                 |  |   |
| <b>Prüflaboratorium:</b><br><i>Testing laboratory:</i>   | TÜV Rheinland (Shanghai)<br>Co., Ltd.   |  |                                 |  |   |
| <b>Prüfergebnis*:</b><br><i>Test result*:</i>  | Pass  |  |                                 |  |   |
| <b>geprüft von / tested by:</b>  | <b>kontrolliert von / reviewed by:</b>  |  |                                 |  |   |
| See test report 50336830 001   | See test report 50336830 001  |  |                                 |  |   |
| <b>Datum</b><br><i>Date</i>  | <b>Name / Stellung</b><br><i>Name / Position</i>  | <b>Unterschrift</b><br><i>Signature</i>  | <b>Datum</b><br><i>Date</i>     | <b>Name / Stellung</b><br><i>Name / Position</i> | <b>Unterschrift</b><br><i>Signature</i> |
| <b>Sonstiges / Other:</b>  |   |  |                                 |  |   |
| <b>Zustand des Prüfgegenstandes bei Anlieferung:</b><br><i>Condition of the test item at delivery:</i>   |   | Prüfmuster vollständig und unbeschädigt<br><i>Test item complete and undamaged</i>   |                                 |  |   |
| <p>* Legende: 1 = sehr gut    2 = gut    3 = befriedigend    4 = ausreichend    5 = mangelhaft<br/> P(ass) = entspricht o.g. Prüfgrundlage(n)    F(ail) = entspricht nicht o.g. Prüfgrundlage(n)    N/A = nicht anwendbar    N/T = nicht getestet</p> <p>Legend: 1 = very good    2 = good    3 = satisfactory    4 = sufficient    5 = poor<br/> P(ass) = passed a.m. test specification(s)    F(ail) = failed a.m. test specification(s)    N/A = not applicable    N/T = not tested</p> |   |  |                                 |  |   |
| <p><b>Dieser Prüfbericht bezieht sich nur auf das o.g. Prüfmuster und darf ohne Genehmigung der Prüfstelle nicht auszugsweise vervielfältigt werden. Dieser Bericht berechtigt nicht zur Verwendung eines Prüfzeichens.</b><br/> <i>This test report only relates to the a. m. test sample. Without permission of the test center this test report is not permitted to be duplicated in extracts. This test report does not entitle to carry any test mark.</i></p>                        |   |  |                                 |  |   |

v04



Prüfbericht-Nr.: 50336830 001 Attachment 1  
 Test Report No.: 50336830 001 Attachment 1

Seite 3 von 34  
 Page 3 of 34

**Produktbeschreibung**  
**Product description**

|   |  |  |
|---|--|--|
| 1 | <b>Produktdetails</b><br><i>Product details</i>                | See product description and model list in appendix for detail. |
| 2 | <b>Maße / Gewicht</b><br><i>Dimensions / Weight</i>            | Same as above.   |
| 3 | <b>Bedienelemente</b><br><i>Operating elements</i>             | Same as above.   |
| 4 | <b>Ausstattung / Zubehör</b><br><i>Equipment / Accessories</i> | Same as above.   |
| 5 | <b>Verwendete Materialien</b><br><i>Used materials</i>         | Same as above.   |
| 6 | <b>Sonstiges</b><br><i>Other</i>                               | N/A  |
|   |  |  |
|   |  |  |

**Prüfbericht-Nr.: 50336830 001 Attachment 1**  
*Test Report No.: 50336830 001 Attachment 1*

Seite 4 von 34  
Page 4 of 34

|        |                         |                            |            |
|--------|-------------------------|----------------------------|------------|
| Absatz | Anforderungen-Prüfungen | Messergebnisse-Bemerkungen | Bewertung  |
| Clause | Requirements-Tests      | Measuring results-Remarks  | Evaluation |

|              |   |  |   |   |                                     |   |                          |     |                          |     |                          |
|--------------|---|--|---|---|-------------------------------------|---|--------------------------|-----|--------------------------|-----|--------------------------|
| <b>1</b>     | <b>Anwendungsbereich</b><br><b>Scope</b>  |  |   |   |                                     |   |                          |     |                          |     |                          |
|              | <p>Diese DIN-VDE-Vornorm dient dem Nachweis der elektrischen Eigenschaften von Erzeugungseinheiten (EZE) nach der VDE-AR N 4105:2018-11 und gegebenenfalls anderen Netzanschlussbedingungen.</p> <p><i>This DIN VDE preliminary standard serves to verify the electrical properties of power generation units (PGU) in accordance with VDE-AR N 4105:2018-11 and, if applicable, other grid connection conditions.</i></p>              |  |   |   |                                     |   |                          |     |                          |     |                          |
| <b>2</b>     | <b>Normative Verweise</b><br><b>Normative References</b>  |  |   |   |                                     |   |                          |     |                          |     |                          |
| <b>3</b>     | <b>Begriffe und Abkürzungen</b><br><b>Terms and abbreviations</b>   |  |   |   |                                     |   |                          |     |                          |     |                          |
| <b>4</b>     | <b>Anforderungen an die Messgeräte und den Prüfstand</b><br><b>Requirements for the measuring instruments and the test bench</b>  |  |   |   |                                     |   |                          |     |                          |     |                          |
|              | <p>In diesem Abschnitt werden allgemeine Anforderungen an Messungen und Messequipment definiert. Abweichende, testspezifische Anforderungen sind den einzelnen Abschnitten des jeweiligen Tests zu entnehmen.</p> <p><i>This section defines general requirements for measurements and measurement equipment. Deviating, test-specific requirements can be found in the individual sections of each test.</i></p>                       |  | <table> <tr> <td>P</td> <td><input checked="" type="checkbox"/></td> </tr> <tr> <td>F</td> <td><input type="checkbox"/></td> </tr> <tr> <td>N/A</td> <td><input type="checkbox"/></td> </tr> <tr> <td>N/T</td> <td><input type="checkbox"/></td> </tr> </table> | P | <input checked="" type="checkbox"/> | F | <input type="checkbox"/> | N/A | <input type="checkbox"/> | N/T | <input type="checkbox"/> |
| P            | <input checked="" type="checkbox"/>   |  |   |   |                                     |   |                          |     |                          |     |                          |
| F            | <input type="checkbox"/>  |  |   |   |                                     |   |                          |     |                          |     |                          |
| N/A          | <input type="checkbox"/>  |  |   |   |                                     |   |                          |     |                          |     |                          |
| N/T          | <input type="checkbox"/>  |  |   |   |                                     |   |                          |     |                          |     |                          |
| <b>5</b>     | <b>Prüfungen</b><br><b>Tests</b>  |  |   |   |                                     |   |                          |     |                          |     |                          |
| <b>5.1</b>   | <b>Allgemeines</b><br><b>General information</b>  |  |   |   |                                     |   |                          |     |                          |     |                          |
|              | <p>Bei Vollumrichterbasierten EZE und hinreichend realistischer Nachbildung der elektrischen Energiequelle dürfen die Messungen auch lediglich am Umrichter und den relevanten Komponenten durchgeführt werden.</p> <p><i>In the case of full converter-based PGU and sufficiently realistic simulation of the electrical energy source, the measurements may only be carried out on the converter and the relevant components.</i></p> |  |   |   |                                     |   |                          |     |                          |     |                          |
| <b>5.2</b>   | <b>Nachweis zulässiger Netzzrückwirkungen</b><br><b>Verification of permissible network perturbations</b>   |  |   |   |                                     |   |                          |     |                          |     |                          |
|              | <p>Dieser Abschnitt dient dem Nachweis der Anforderungen der VDE AR N 4105:2018-11, 5.4. Diese verweist bzgl. der Netzzrückwirkungen auf die VDE-AR-N 4100:2019-04, 5.4.</p> <p><i>This section serves as proof of the requirements of VDE AR N 4105:2018-11, 5.4, which refers to VDE-AR-N 4100:2019-04, 5.4 with regard to network perturbations.</i></p>   |  |   |   |                                     |   |                          |     |                          |     |                          |
| <b>5.2.1</b> | <b>Allgemeines</b><br><b>General information</b>  |  |   |   |                                     |   |                          |     |                          |     |                          |

Prüfbericht-Nr.: 50336830 001 Attachment 1  
Test Report No.: 50336830 001 Attachment 1

Seite 5 von 34  
Page 5 of 34

| Absatz | Anforderungen-Prüfungen | Messergebnisse-Bemerkungen | Bewertung  |
|--------|-------------------------|----------------------------|------------|
| Clause | Requirements-Tests      | Measuring results-Remarks  | Evaluation |

|              |   |                          |  |   |                                     |   |                          |     |                          |     |                          |
|--------------|---|--------------------------|--|---|-------------------------------------|---|--------------------------|-----|--------------------------|-----|--------------------------|
|              | <p>Netzrückwirkungen im Sinne dieses Dokumentes nach VDE-AR-N 4100:2019-04, 5.4 sind:</p> <ul style="list-style-type: none"> <li>- schnelle Spannungsänderungen;</li> <li>- Flicker;</li> <li>- Oberschwingungen, Zwischenharmonische und Supraharmonische (Höhere Frequenzen von 2 bis 9 kHz);</li> <li>- Kommutierungseinbrüche;</li> <li>- Einspeisung von Gleichströmen.</li> </ul> <p><i>Network perturbations within the meaning of this document according to VDE-AR-N 4100:2019-04, 5.4:</i></p> <ul style="list-style-type: none"> <li>- <i>Fast voltage changes;</i></li> <li>- <i>Flicker;</i></li> <li>- <i>Harmonics, interharmonics and supraharmonics (higher frequencies from 2 to 9 kHz);</i></li> <li>- <i>Commutation dips;</i></li> <li>- <i>Feed-in of direct currents.</i></li> </ul> |                          |  |   |                                     |   |                          |     |                          |     |                          |
| <b>5.2.2</b> | <p><b>Schnelle Spannungsänderungen</b><br/><b>Rapid voltage changes</b></p>   |                          |  |   |                                     |   |                          |     |                          |     |                          |
|              | <p>Diese Prüfungen dienen dem Nachweis der Anforderungen der VDE-AR-N 4100:2019-04.</p> <p><i>These tests serve as proof of the requirements of VDE-AR-N 4100:2019-04.</i></p>  | See appendix for detail. | <table style="width: 100%; border: none;"> <tr><td>P</td><td><input checked="" type="checkbox"/></td></tr> <tr><td>F</td><td><input type="checkbox"/></td></tr> <tr><td>N/A</td><td><input type="checkbox"/></td></tr> <tr><td>N/T</td><td><input type="checkbox"/></td></tr> </table> | P | <input checked="" type="checkbox"/> | F | <input type="checkbox"/> | N/A | <input type="checkbox"/> | N/T | <input type="checkbox"/> |
| P            | <input checked="" type="checkbox"/>   |                          |  |   |                                     |   |                          |     |                          |     |                          |
| F            | <input type="checkbox"/>  |                          |  |   |                                     |   |                          |     |                          |     |                          |
| N/A          | <input type="checkbox"/>  |                          |  |   |                                     |   |                          |     |                          |     |                          |
| N/T          | <input type="checkbox"/>  |                          |  |   |                                     |   |                          |     |                          |     |                          |
| <b>5.2.3</b> | <p><b>Flicker</b><br/><b>Flicker</b></p>  |                          |  |   |                                     |   |                          |     |                          |     |                          |
|              | <p>Diese Prüfungen dienen dem Nachweis der Anforderungen der VDE-AR-N 4100:2019-04.</p> <p><i>These tests serve as proof of the requirements of VDE-AR-N 4100:2019-04.</i></p>  | See appendix for detail. | <table style="width: 100%; border: none;"> <tr><td>P</td><td><input checked="" type="checkbox"/></td></tr> <tr><td>F</td><td><input type="checkbox"/></td></tr> <tr><td>N/A</td><td><input type="checkbox"/></td></tr> <tr><td>N/T</td><td><input type="checkbox"/></td></tr> </table> | P | <input checked="" type="checkbox"/> | F | <input type="checkbox"/> | N/A | <input type="checkbox"/> | N/T | <input type="checkbox"/> |
| P            | <input checked="" type="checkbox"/>   |                          |  |   |                                     |   |                          |     |                          |     |                          |
| F            | <input type="checkbox"/>  |                          |  |   |                                     |   |                          |     |                          |     |                          |
| N/A          | <input type="checkbox"/>  |                          |  |   |                                     |   |                          |     |                          |     |                          |
| N/T          | <input type="checkbox"/>  |                          |  |   |                                     |   |                          |     |                          |     |                          |
| <b>5.2.4</b> | <p><b>Oberschwingungen und Zwischenharmonische</b><br/><b>Harmonics and interharmonics</b></p>  |                          |  |   |                                     |   |                          |     |                          |     |                          |
|              | <p>Diese Prüfungen dienen dem Nachweis der Anforderungen der VDE AR N 4100:2019-04. Ziel der Prüfung ist es, die Ströme der Oberschwingungen, der Zwischenharmonischen und der Supraharmonischen (zwischen 2 kHz und 9 kHz) zu bestimmen.</p> <p><i>These tests serve as proof of the requirements of VDE AR N 4100:2019-04.</i></p> <p><i>The aim of the test is to determine the currents of the harmonics, the interharmonics and the supraharmonics (between 2 kHz and 9 kHz).</i></p>  | See appendix for detail. | <table style="width: 100%; border: none;"> <tr><td>P</td><td><input checked="" type="checkbox"/></td></tr> <tr><td>F</td><td><input type="checkbox"/></td></tr> <tr><td>N/A</td><td><input type="checkbox"/></td></tr> <tr><td>N/T</td><td><input type="checkbox"/></td></tr> </table> | P | <input checked="" type="checkbox"/> | F | <input type="checkbox"/> | N/A | <input type="checkbox"/> | N/T | <input type="checkbox"/> |
| P            | <input checked="" type="checkbox"/>   |                          |  |   |                                     |   |                          |     |                          |     |                          |
| F            | <input type="checkbox"/>  |                          |  |   |                                     |   |                          |     |                          |     |                          |
| N/A          | <input type="checkbox"/>  |                          |  |   |                                     |   |                          |     |                          |     |                          |
| N/T          | <input type="checkbox"/>  |                          |  |   |                                     |   |                          |     |                          |     |                          |
| <b>5.2.5</b> | <p><b>Kommutierungseinbrüche</b><br/><b>Communication notches</b></p>   |                          |  |   |                                     |   |                          |     |                          |     |                          |

Prüfbericht-Nr.: 50336830 001 Attachment 1  
Test Report No.: 50336830 001 Attachment 1

Seite 6 von 34  
Page 6 of 34

| Absatz | Anforderungen-Prüfungen | Messergebnisse-Bemerkungen | Bewertung  |
|--------|-------------------------|----------------------------|------------|
| Clause | Requirements-Tests      | Measuring results-Remarks  | Evaluation |

|              |   |                              |   |
|--------------|---|------------------------------|---|
|              | <p>Diese Prüfung dient der Ermittlung der Kommutierungsströme, die zur projektspezifischen Ermittlung und Beurteilung der Kommutierungsspannungseinbrüche nach VDE-AR-N 4100:2019-04, 5.4.4.4 unter Berücksichtigung der Kurzschlussleistung am Verknüpfungspunkt erforderlich ist.</p> <p>Diese Prüfung ist nur für netzgeführte Umrichter erforderlich.</p> <p><i>This test serves to determine the commutation currents required for the project-specific determination and assessment of the commutation voltage dips according to VDE-AR-N 4100:2019-04, 5.4.4.4 under consideration of the short-circuit power at the connection point.</i></p> <p><i>This test is only required for line-commutated inverters.</i></p> | See appendix for detail.     | P <input checked="" type="checkbox"/><br>F <input type="checkbox"/><br>N/A <input type="checkbox"/><br>N/T <input type="checkbox"/> |
| <b>5.2.6</b> | <b>Einspeisung von Gleichströmen</b><br><b>Feed-in of direct currents</b>   |                              |   |
|              | <p>Diese Prüfungen dienen dem Nachweis der Anforderungen der VDE AR N 4100:2019-04. Ziel der Prüfung ist es nachzuweisen, dass keine unzulässigen Gleichstromanteile in das Niederspannungsnetz eingespeist werden. Diese Prüfung ist nur für Umrichter erforderlich.</p> <p><i>These tests serve as proof of the requirements of VDE AR N 4100:2019-04.</i></p> <p><i>The aim of the test is to prove that no inadmissible direct current components are fed into the low-voltage network.</i></p> <p><i>This test is only required for inverters.</i></p>   | See appendix for detail.     | P <input checked="" type="checkbox"/><br>F <input type="checkbox"/><br>N/A <input type="checkbox"/><br>N/T <input type="checkbox"/> |
| <b>5.3</b>   | <b>Nachweis des Symmetrieverhaltens von Umrichtern</b><br><b>Verification of the symmetry behaviour of inverters</b>  |                              |   |
| <b>5.3.1</b> | <b>Allgemeines</b><br><b>General information</b>  |                              |   |
|              | <p>Diese Prüfungen dienen dem Nachweis der Anforderungen der VDE AR N 4100:2019-04, 5.5. Diese Prüfungen gelten nicht für rotierende Generatoren, die direkt an das Verteilnetz angeschlossen sind.</p> <p><i>These tests serve as proof of the requirements of VDE AR N 4100:2019-04, 5.5.</i></p> <p><i>These tests do not apply to rotating generators connected directly to the distribution network.</i></p>   | Single phase product ≤4.6kVA | P <input type="checkbox"/><br>F <input type="checkbox"/><br>N/A <input checked="" type="checkbox"/><br>N/T <input type="checkbox"/> |
| <b>5.4</b>   | <b>Nachweis des Verhaltens der Erzeugungseinheit am Netz</b><br><b>Proof of the behaviour of the power generation unit on the grid</b>  |                              |   |

Prüfbericht-Nr.: 50336830 001 Attachment 1  
Test Report No.: 50336830 001 Attachment 1

Seite 7 von 34  
Page 7 of 34

| Absatz | Anforderungen-Prüfungen | Messergebnisse-Bemerkungen | Bewertung  |
|--------|-------------------------|----------------------------|------------|
| Clause | Requirements-Tests      | Measuring results-Remarks  | Evaluation |

|              |  |                          |   |
|--------------|--|--------------------------|---|
| <b>5.4.1</b> | <b>Allgemeines</b><br><i>General information</i>   |                          |   |
|              | <p>Diese Prüfungen dienen dem Nachweis des einstellbaren Blindleistungsbereiches nach Anforderungen der VDE-AR-N 4105:2018-11(Kap. 5.7.2.2), sowie zur Ermittlung der Werte für SEmax und PEmax.</p> <p>Die RoCoF Anforderungen aus der VDE-AR-N 4105:2018-11, 5.7.1 sind nicht Teil der Einheitenzertifizierung.</p> <p><i>These tests serve to verify the adjustable reactive power range in accordance with the requirements of VDE-AR-N 4105:2018-11 (Section 5.7.2.2) and to determine the values for SEmax and PEmax.</i></p> <p><i>The RoCoF requirements from VDE-AR-N 4105:2018-11, 5.7.1 are not part of the unit certification.</i></p> | See appendix for detail. | P <input checked="" type="checkbox"/><br>F <input type="checkbox"/><br>N/A <input type="checkbox"/><br>N/T <input type="checkbox"/> |
| <b>5.4.2</b> | <b>Messung des Wirk- und Blindleistungsbereiches</b><br><i>Measurement of active and reactive power range</i>  |                          |   |
|              | <p>Diese Prüfungen dienen dem Nachweis des einstellbaren Blindleistungsbereiches nach Anforderungen der VDE-AR-N 4105:2018-11(Kap. 5.7.2.2), sowie zur Ermittlung der Werte für SEmax und PEmax.</p> <p>Die RoCoF Anforderungen aus der VDE-AR-N 4105:2018-11, 5.7.1 sind nicht Teil der Einheitenzertifizierung.</p> <p><i>These tests serve to verify the adjustable reactive power range in accordance with the requirements of VDE-AR-N 4105:2018-11 (Section 5.7.2.2) and to determine the values for SEmax and PEmax.</i></p> <p><i>The RoCoF requirements from VDE-AR-N 4105:2018-11, 5.7.1 are not part of the unit certification.</i></p> | See appendix for detail. | P <input checked="" type="checkbox"/><br>F <input type="checkbox"/><br>N/A <input type="checkbox"/><br>N/T <input type="checkbox"/> |
| <b>5.4.3</b> | <b>Wirkleistungsreduktion durch Sollwertvorgabe</b><br><i>Active power reduction by setpoint input</i>   |                          |   |



Prüfbericht-Nr.: 50336830 001 Attachment 1  
Test Report No.: 50336830 001 Attachment 1

Seite 8 von 34  
Page 8 of 34

| Absatz | Anforderungen-Prüfungen | Messergebnisse-Bemerkungen | Bewertung  |
|--------|-------------------------|----------------------------|------------|
| Clause | Requirements-Tests      | Measuring results-Remarks  | Evaluation |

|              |   |                          |   |
|--------------|---|--------------------------|---|
|              | <p>Für EZE, welche nach VDE-AR-N 4105:2018-11, 5.7.4.2.1 am Einspeisemanagement/Netzsicherheitsmanagement teilnehmen müssen, sowie EZE, welche laut Herstellerangaben am Einspeisemanagement/Netzsicherheitsmanagement teilnehmen können, gelten nachstehende Prüfungen.<br/>Die Messungen sind, wenn technisch möglich, bei einer Vorgabe des Verschiebungsfaktors von 1 durchzuführen.</p> <p><i>The following tests apply to PGU, which according to VDE-AR-N 4105:2018-11, 5.7.4.2.1 must participate in feed-in management/grid safety management, and EZE, which according to the manufacturer's specifications can participate in feed-in management/grid safety management.</i></p> <p><i>If technically possible, the measurements must be carried out with a default shift factor of 1.</i></p> | See appendix for detail. | P <input checked="" type="checkbox"/><br>F <input type="checkbox"/><br>N/A <input type="checkbox"/><br>N/T <input type="checkbox"/> |
| <b>5.4.4</b> | <b>Wirkleistungseinspeisung von EZE bei Überfrequenz</b><br><b>Active power input from PGU at overfrequency</b>   |                          |   |
|              | <p>Die Prüfung dient dem Nachweis der Wirkleistungsreduktion der EZE bei Überfrequenz nach VDE-AR-N 4105:2018-11 5.7.4.3. sowie dem Nachweis des Wirkleistungsgradienten nach Wiedereinschalten nach VDE-AR-N 4105:2018-11, 8.3.1. Falls einstellbar, ist die Prüfung zur Vergleichbarkeit mit einer <math>\cos(\varphi)</math> Vorgabe von 1 durchzuführen.</p> <p><i>The test serves to prove the active power reduction of the PGU at overfrequency according to VDE-AR-N 4105:2018-11 5.7.4.3. as well as to prove the efficiency gradient after reconnection according to VDE-AR-N 4105:2018-11, 8.3.1. If adjustable, the test shall be carried out with a <math>\cos(\varphi)</math> specification of 1 for comparability.</i></p>   | See appendix for detail. | P <input checked="" type="checkbox"/><br>F <input type="checkbox"/><br>N/A <input type="checkbox"/><br>N/T <input type="checkbox"/> |
| <b>5.4.5</b> | <b>Wirkleistungseinspeisung von Speichern bei Überfrequenz</b><br><b>Active power input from energy storage systems at overfrequency</b>  |                          |   |

**Prüfbericht-Nr.: 50336830 001 Attachment 1**  
**Test Report No.: 50336830 001 Attachment 1**

Seite 9 von 34  
 Page 9 of 34

| Absatz | Anforderungen-Prüfungen | Messergebnisse-Bemerkungen | Bewertung  |
|--------|-------------------------|----------------------------|------------|
| Clause | Requirements-Tests      | Measuring results-Remarks  | Evaluation |

|              |   |                          |   |
|--------------|---|--------------------------|---|
|              | <p>Die Prüfung dient dem Nachweis der Wirkleistungsreduktion des Speichers bei Überfrequenz nach VDE-AR-N 4105:2018-115.7.4.3, sowie dem Nachweis des Wirkleistungsgradienten nach Wiedereinschalten nach VDE-AR-N 4105:2018-11, 8.3.1. Falls einstellbar, ist die Prüfung zur Vergleichbarkeit mit einer <math>\cos(\varphi)</math> Vorgabe von 1 durchzuführen</p> <p><i>The test serves to verify the active power reduction of the storage in the event of overfrequency in accordance with VDE-AR-N 4105:2018-115.7.4.3, as well as the verification of the efficiency gradient after reconnection in accordance with VDE-AR-N 4105:2018-11, 8.3.1. If adjustable, the test shall be carried out with a <math>\cos(\varphi)</math> specification of 1 for comparability.</i></p> |                          | P <input type="checkbox"/><br>F <input type="checkbox"/><br>N/A <input checked="" type="checkbox"/><br>N/T <input type="checkbox"/> |
| <b>5.4.6</b> | <p><b>Wirkleistungseinspeisung für EZE bei Unterfrequenz</b><br/> <b>Active power supply for PGU at low frequency</b></p>   |                          |   |
|              | <p>Die Prüfung dient dem Nachweis der Wirkleistungserhöhung der EZE bei Unterfrequenz nach VDE-AR-N 4105:2018-11 5.7.4.3 sowie dem Nachweis des Wirkleistungsgradienten nach Wiedereinschalten nach VDE-AR-N 4105:2018-11, 8.3.1. Falls einstellbar, ist die Prüfung zur Vergleichbarkeit mit einer <math>\cos(\varphi)</math> Vorgabe von 1 durchzuführen.</p> <p><i>The test serves to verify the increase in active power of the PGU at underfrequency according to VDE-AR-N 4105:2018-11 5.7.4.3 as well as the verification of the efficiency gradient after reconnection according to VDE-AR-N 4105:2018-11, 8.3.1. If adjustable, the test shall be carried out for comparability with a <math>\cos(\varphi)</math> specification of 1.</i></p>                                | See appendix for detail. | P <input checked="" type="checkbox"/><br>F <input type="checkbox"/><br>N/A <input type="checkbox"/><br>N/T <input type="checkbox"/> |
| <b>5.4.7</b> | <p><b>Wirkleistungseinspeisung von Speichern bei Unterfrequenz</b><br/> <b>Active power input from energy storage systems at underfrequency</b></p>   |                          |   |

Prüfbericht-Nr.: 50336830 001 Attachment 1  
Test Report No.: 50336830 001 Attachment 1

Seite 10 von 34  
Page 10 of 34

| Absatz | Anforderungen-Prüfungen | Messergebnisse-Bemerkungen | Bewertung  |
|--------|-------------------------|----------------------------|------------|
| Clause | Requirements-Tests      | Measuring results-Remarks  | Evaluation |

|              |   |                                     |   |
|--------------|---|-------------------------------------|---|
|              | <p>Die Prüfung dient dem Nachweis der Wirkleistungserhöhung des Speichers bei Unterfrequenz nach VDE-AR-N 4105:2018-11 5.7.4.3. sowie dem Nachweis des Wirkleistungsgradienten nach Wiedereinschalten nach VDE-AR-N 4105:2018-11, 8.3.1. Falls einstellbar, ist die Prüfung zur Vergleichbarkeit mit einer <math>\cos(\varphi)</math> Vorgabe von 1 durchzuführen. Die Prüfungen sind unter Verwendung einer Schnittstelle zur Wirkleistungsreduzierung durchzuführen, die geringer priorisiert ist als die Wirkleistungseinspeisung bei Unterfrequenz (Details sind in Abschnitt 8.1 der VDE-AR-N 4105:2018-11 gegeben). Ist eine solche Schnittstelle nicht vorhanden, ist dies zu dokumentieren und die Prüfung entfällt.</p> <p><i>The purpose of the test is to verify the increase in active power of the energy storage system at underfrequency in accordance with VDE-AR-N 4105:2018-11 5.7.4.3. and to verify the efficiency gradient after reconnection in accordance with VDE-AR-N 4105:2018-11, 8.3.1. If adjustable, the test shall be performed for comparability with a <math>\cos(\varphi)</math> specification of 1. The tests shall be performed using an interface for active power reduction which has a lower priority than the active power input at low frequency (details are given in Section 8.1 of VDE-AR-N 4105:2018-11). If such an interface is not available, this shall be documented and the test shall be omitted.</i></p> | DC coupled energy storage inverter. | P <input type="checkbox"/><br>F <input type="checkbox"/><br>N/A <input checked="" type="checkbox"/><br>N/T <input type="checkbox"/> |
| <b>5.4.8</b> | <b>Statische Spannunshaltung / Blindleistungsbereitstellung</b>   |                                     |   |
|              | <b>Static voltage holding / reactive power supply</b>   |                                     |   |
|              | <p>Die Prüfung dient dem Nachweis der Blindleistungsfahrweise nach VDE-AR-N 4105:2018-11, 5.7.2 der EZE im Normalbetrieb. Alle Prüfungen sind bei den jeweils angegebenen Spannungen durchzuführen. Wenn Prüfstandmessungen nicht möglich sind, ist eine technisch begründete Erklärung des Herstellers vorzulegen. Bei Anlagen, die über Wechselrichter an das Netz angeschlossen werden, darf der Wechselrichter alleine geprüft werden.</p> <p><i>The test serves as proof of reactive power operation according to VDE-AR-N 4105:2018-11, 5.7.2 of the PGU in normal operation. All tests must be carried out at the specified voltages. If test bench measurements are not possible, a technically justified declaration by the manufacturer shall be submitted. For systems which are connected to the grid via inverters, the inverter may be tested alone.</i></p>  | See appendix for detail.            | P <input checked="" type="checkbox"/><br>F <input type="checkbox"/><br>N/A <input type="checkbox"/><br>N/T <input type="checkbox"/> |

Prüfbericht-Nr.: 50336830 001 Attachment 1  
Test Report No.: 50336830 001 Attachment 1

Seite 11 von 34  
Page 11 of 34

| Absatz | Anforderungen-Prüfungen | Messergebnisse-Bemerkungen | Bewertung  |
|--------|-------------------------|----------------------------|------------|
| Clause | Requirements-Tests      | Measuring results-Remarks  | Evaluation |

|                |  |   |   |
|----------------|--|---|---|
| <b>5.4.8.1</b> | <b>Prüfungen der Blindleistungs/Verschiebungsfaktor Einstellgenauigkeit</b><br><i>Reactive power/displacement factor tests setting accuracy</i>  |   |   |
|                | Die Messungen sind bei 0,9 Un, Un und 1,1 Un mit einer Toleranz von $\pm 2\%$ Un durchzuführen.<br>Die Einschränkungen der spannungsabhängigen Blindleistungsstellbereiche laut VDE-AR-N 4105:2018-11, Bild 2 – 4, sind zu berücksichtigen.<br><br><i>Measurements shall be made at 0,9 Un, Un and 1,1 Un with a tolerance of <math>\pm 2\%</math> Un.<br/>The restrictions of the voltage-dependent reactive power control ranges according to VDE-AR-N 4105:2018-11, Figs. 2 - 4, must be taken into account.</i>                          | See appendix for detail.  | P <input checked="" type="checkbox"/><br>F <input type="checkbox"/><br>N/A <input type="checkbox"/><br>N/T <input type="checkbox"/> |
| <b>5.4.8.2</b> | <b>Prüfung der Verschiebungsfaktor-/Wirkleistungskennlinie cos (P)</b><br><i>Testing the displacement factor/effective power characteristic curve cos (P)</i>  |   |   |
|                | Dieser Abschnitt dient der Überprüfung der in VDE-AR-N 4105:2018-11, 5.7.2.4 b) dargestellten Standardkennlinie für cos (P).<br>Die Blindleistungsregelung für dieses Kennlinienverfahren ist hinsichtlich stationärer Genauigkeit und Dynamik zu beurteilen.<br><br><i>This section serves to check the standard characteristic curve for cos (P) shown in VDE-AR-N 4105:2018-11, 5.7.2.4 b).<br/>The reactive power control for this characteristic curve method shall be evaluated with regard to steady-state accuracy and dynamics.</i> | See appendix for detail.  | P <input checked="" type="checkbox"/><br>F <input type="checkbox"/><br>N/A <input type="checkbox"/><br>N/T <input type="checkbox"/> |
| <b>5.4.8.3</b> | <b>Prüfung der Blindleistungs-Spannungskennlinie Q(U)</b><br><i>Testing the reactive power voltage characteristic Q(U)</i>   |   |   |
|                | Die Überprüfung der Q(U)-Regelung nach VDE-AR-N 4105:2018-05, 5.7.2.4 ist in zwei Teilprüfungen geteilt, sodass einerseits die Genauigkeit und andererseits die Dynamik der Q(U)-Regelung geprüft wird.<br><br><i>The verification of the Q(U) control according to VDE-AR-N 4105:2018-05, 5.7.2.4 is divided into two partial tests, so that on the one hand the accuracy and on the other hand the dynamics of the Q(U) control are checked.</i>   | Q(U) function is not required per requirements in VDE-AR-N 4105/11.18 | P <input type="checkbox"/><br>F <input type="checkbox"/><br>N/A <input checked="" type="checkbox"/><br>N/T <input type="checkbox"/> |
| <b>5.5</b>     | <b>Nachweise des NA-Schutzes</b><br><i>Proof of NS-protection</i>  |   |   |
| <b>5.5.1</b>   | <b>Allgemeines</b><br><i>General information</i>   |   |   |

Prüfbericht-Nr.: 50336830 001 Attachment 1  
Test Report No.: 50336830 001 Attachment 1

Seite 12 von 34  
Page 12 of 34

| Absatz | Anforderungen-Prüfungen | Messergebnisse-Bemerkungen | Bewertung  |
|--------|-------------------------|----------------------------|------------|
| Clause | Requirements-Tests      | Measuring results-Remarks  | Evaluation |

|              |   |                          |   |
|--------------|---|--------------------------|---|
|              | <p>Diese Prüfungen dienen dem Nachweis der Anforderungen der VDE AR N 4105:2018-11, Abschnitt 6.</p> <p><i>These tests serve as proof of the requirements of VDE AR N 4105:2018-11, Section 6.</i></p>  |                          | P <input checked="" type="checkbox"/><br>F <input type="checkbox"/><br>N/A <input type="checkbox"/><br>N/T <input type="checkbox"/> |
| <b>5.5.2</b> | <p><b>NA-Schutz</b><br/><b>NS-protection</b></p>  |                          |   |
|              | <p>Die Prüfung auf Fehlererkennung mit nachfolgender Abschaltung erfolgt durch Fehlersimulation, gegebenenfalls mit zusätzlichen Fehlertests (siehe VDE AR N 4105:2018-11, 6.1)</p> <p>Für EZE, welche die Anforderungen nach DIN EN 62109 (VDE 0126-14) nachweislich erfüllen, müssen die Prüfungen nicht durchgeführt werden. Der Nachweis in Form eines Prüfberichts eines akkreditierten Prüflabors oder eines Komponentenzertifikates ist vorzulegen.</p> <p><i>The check for fault detection with subsequent switch-off is carried out by fault simulation, if necessary with additional fault tests (see VDE AR N 4105:2018-11, 6.1).</i></p> <p><i>For PGU, which demonstrably meet the requirements of DIN EN 62109 (VDE 0126-14), the tests do not have to be carried out. Evidence in the form of a test report from an accredited test laboratory or a component certificate must be submitted.</i></p> | See appendix for detail. | P <input checked="" type="checkbox"/><br>F <input type="checkbox"/><br>N/A <input type="checkbox"/><br>N/T <input type="checkbox"/> |
| <b>5.5.3</b> | <p><b>Zentraler NA-Schutz</b><br/><b>Central NS-protection</b></p>  |                          |   |
|              | <p>Die folgenden Prüfungen sind der Reihe nacheinander durchzuführen:</p> <ul style="list-style-type: none"> <li>- Die Hilfsspannung des NA-Schutzes wird abgeschaltet.</li> <li>- Die Prüfeinrichtung am NA-Schutz wird betätigt.</li> </ul> <p><i>The following tests shall be carried out one after the other:</i></p> <ul style="list-style-type: none"> <li>- <i>The auxiliary voltage of the NS-protection is switched off.</i></li> <li>- <i>The test device on the NS-protection is actuated.</i></li> </ul>  |                          | P <input type="checkbox"/><br>F <input type="checkbox"/><br>N/A <input checked="" type="checkbox"/><br>N/T <input type="checkbox"/> |
| <b>5.5.4</b> | <p><b>Integrierter NA-Schutz</b><br/><b>Integrated NS-protection</b></p>  |                          |   |

Prüfbericht-Nr.: 50336830 001 Attachment 1  
Test Report No.: 50336830 001 Attachment 1

Seite 13 von 34  
Page 13 of 34

| Absatz | Anforderungen-Prüfungen | Messergebnisse-Bemerkungen | Bewertung  |
|--------|-------------------------|----------------------------|------------|
| Clause | Requirements-Tests      | Measuring results-Remarks  | Evaluation |

|                |  |                          |   |
|----------------|--|--------------------------|---|
|                | <p>Die Prüfung des integrierten NA-Schutzes erfolgt im Kapitel 5.5.7 und im Zusammenhang mit der Prüfung der Gesamtwirkungskette NA-Schutz – Kuppelschalter.</p> <p><i>The integrated NS-protection is tested in chapter 5.5.7 and in connection with the testing of the overall chain of action of the NS-protection - coupling switch.</i></p>   | See appendix for detail. | P <input checked="" type="checkbox"/><br>F <input type="checkbox"/><br>N/A <input type="checkbox"/><br>N/T <input type="checkbox"/> |
| <b>5.5.5</b>   | <p><b>Dokumentation</b><br/><i>Documentation</i></p>   |                          |   |
|                | <p>Es ist mindestens festzuhalten:</p> <ul style="list-style-type: none"> <li>- Die durchgeführte Fehlersimulation und/oder Fehlertests sowie das Ergebnis</li> <li>- Die Art des NA-Schutzes (zentral oder integriert)</li> <li>- Ob das Signal für die unverzögerte Auslösung erzeugt wurde</li> </ul> <p>- Anforderung an die Schnittstelle der EZE bzw. Kuppelschalter sind zu definieren</p> <p><i>It shall at least be recorded:</i></p> <ul style="list-style-type: none"> <li>- <i>The error simulation and/or error tests carried out and the result</i></li> <li>- <i>The type of NS-protection (central or integrated)</i></li> <li>- <i>Whether the signal for instantaneous tripping was generated</i></li> <li>- <i>Requirements for the interface of the PGU or coupling switch must be defined.</i></li> </ul> | See appendix for detail. | P <input checked="" type="checkbox"/><br>F <input type="checkbox"/><br>N/A <input type="checkbox"/><br>N/T <input type="checkbox"/> |
| <b>5.5.6</b>   | <p><b>Kuppelschalter</b><br/><i>Interface switch</i></p>   |                          |   |
| <b>5.5.6.1</b> | <p><b>Allgemeines</b><br/><i>General information</i></p>   |                          |   |
|                | <p>Diese Prüfungen dienen dem Nachweis der Anforderungen der VDE AR N 4105:2018-11, 6.4</p> <p><i>These tests serve as proof of the requirements of VDE AR N 4105:2018-11, 6.4</i></p>   |                          | P <input checked="" type="checkbox"/><br>F <input type="checkbox"/><br>N/A <input type="checkbox"/><br>N/T <input type="checkbox"/> |
| <b>5.5.6.2</b> | <p><b>Zentraler Kuppelschalter</b><br/><i>Central interface switch</i></p>   |                          |   |

**Prüfbericht-Nr.: 50336830 001 Attachment 1**  
*Test Report No.: 50336830 001 Attachment 1*

Seite 14 von 34  
 Page 14 of 34

| Absatz | Anforderungen-Prüfungen | Messergebnisse-Bemerkungen | Bewertung  |
|--------|-------------------------|----------------------------|------------|
| Clause | Requirements-Tests      | Measuring results-Remarks  | Evaluation |

|                |  |  |  |
|----------------|--|--|--|
|                | <p>Zur Auslegung eines zentralen Kuppelschalters sind einige Angaben der EZE notwendig. Die Dokumentation des Herstellers der EZE muss daher folgende Angaben enthalten:</p> <ul style="list-style-type: none"> <li>- maximaler Anfangs-Kurzschlusswechselstrom;</li> <li>-</li> <li>- maximale Vorsicherung;</li> <li>- Schaltplan/ Anschlussplan (EZE, NA-Schutz, Kuppelschalter) beinhaltet die erforderlichen Ansteuer- und Rückmeldesignale.</li> </ul> <p><i>Some information from PGU is required for the design of a central dome switch. The documentation of the PGU manufacturer must therefore contain the following information:</i></p> <ul style="list-style-type: none"> <li>- <i>maximum initial short-circuit alternating current;</i></li> <li>-</li> <li>- <i>maximum back-up fuse;</i></li> <li>- <i>Circuit diagram/ connection diagram (PGU, NS-protection, coupling switch) contains the required control and feedback signals.</i></li> </ul> |  | <p>P <input type="checkbox"/></p> <p>F <input type="checkbox"/></p> <p>N/A <input checked="" type="checkbox"/></p> <p>N/T <input type="checkbox"/></p> |
| <b>5.5.6.3</b> | <p><b>Integrierter Kuppelschalter</b><br/> <i>Integrated interface switch</i></p>  |  |  |



Prüfbericht-Nr.: 50336830 001 Attachment 1  
Test Report No.: 50336830 001 Attachment 1

Seite 15 von 34  
Page 15 of 34

| Absatz | Anforderungen-Prüfungen | Messergebnisse-Bemerkungen | Bewertung  |
|--------|-------------------------|----------------------------|------------|
| Clause | Requirements-Tests      | Measuring results-Remarks  | Evaluation |

|                |  |                          |   |
|----------------|--|--------------------------|---|
|                | <p>Bei der Kombination von integriertem Kuppelschalter und integriertem NA-Schutz ist die gesamte Wirkungskette zu überprüfen. Die EZE muss dabei mit dem Netz verbunden sein.<br/>Folgende Wirkungsweisen sind zulässig:</p> <p>a) Verwendung eines Kuppelschalters, bei dem im eingeschalteten Zustand ständig eine Steuerspannung anliegen muss und der selbsttätig abschaltet, wenn diese Spannung nicht anliegt. Die betriebsmäßige Ein- und Ausschaltvorgänge sind zu überwachen.</p> <p>b) Eine mindestens einmal tägliche Ein- und Ausschaltung des Kuppelschalters durch den NA-Schutz und Überwachung der ordnungsgemäßen Funktion des Kuppelschalters</p> <p>c) Verwendung des integrierten Kuppelschalters und des integrierten NA-Schutzes bei PV- und Batterieumrichtern nach DIN EN 62109</p> <p><i>When combining an integrated bus tie breaker and integrated NS-protection, the entire efficiency chain must be checked. The PGU must be connected to the mains. The following modes of action are permissible:</i></p> <p>a) <i>Use of a interface switch with which a control voltage must always be present when switched on and which switches off automatically when this voltage is not present. The operational switch-on and switch-off procedures must be monitored.</i></p> <p>b) <i>The interface switch must be switched on and off at least once a day by the NS-protection and the proper functioning of the coupling switch must be monitored.</i></p> <p>c) <i>Use of the integrated interface switch and the integrated NS-protection for PV and battery converters according to DIN EN 62109</i></p> | See appendix for detail. | P <input checked="" type="checkbox"/><br>F <input type="checkbox"/><br>N/A <input type="checkbox"/><br>N/T <input type="checkbox"/> |
| <b>5.5.7</b>   | <b>Schutzeinrichtungen und Schutzeinstellungen</b><br><i>Protective devices and settings</i>   |                          |   |
| <b>5.5.7.1</b> | <b>Allgemeines</b><br><i>General information</i>   |                          |   |
|                | <p>Diese Prüfungen dienen dem Nachweis der Anforderungen der VDE AR N 4105:2018-11, 6.5.1.<br/><i>These tests serve as proof of the requirements of VDE AR N 4105:2018-11, 6.5.1.</i></p>  |                          | P <input checked="" type="checkbox"/><br>F <input type="checkbox"/><br>N/A <input type="checkbox"/><br>N/T <input type="checkbox"/> |
| <b>5.5.7.2</b> | <b>Spannungsüberwachung und Frequenzüberwachung NA-Schutz</b><br><i>Voltage monitoring and frequency monitoring NS-protection</i>  |                          |   |



Prüfbericht-Nr.: 50336830 001 Attachment 1  
Test Report No.: 50336830 001 Attachment 1

Seite 16 von 34  
Page 16 of 34

| Absatz | Anforderungen-Prüfungen | Messergebnisse-Bemerkungen | Bewertung  |
|--------|-------------------------|----------------------------|------------|
| Clause | Requirements-Tests      | Measuring results-Remarks  | Evaluation |

|                |  |                          |   |
|----------------|--|--------------------------|---|
|                | <p>Prüfung des:</p> <ul style="list-style-type: none"> <li>- Spannungssteigerungsschutzes <math>U_{&gt;&gt;}</math>, <math>U_{&gt;}</math></li> <li>- Spannungsrückgangsschutzes <math>U_{&lt;&lt;}</math>, <math>U_{&lt;}</math></li> <li>- Frequenzsteigerungsschutzes <math>f_{&gt;}</math></li> <li>- Frequenzrückgangsschutzes <math>f_{&lt;}</math></li> </ul> <p>Checking the:</p> <ul style="list-style-type: none"> <li>- Voltage increase protection <math>U_{&gt;&gt;}</math>, <math>U_{&gt;}</math></li> <li>- Voltage drop protection <math>U_{&lt;&lt;}</math>, <math>U_{&lt;}</math></li> <li>- Frequency increase protection <math>f_{&gt;}</math></li> <li>- Frequency drop protection <math>f_{&lt;}</math></li> </ul>   | See appendix for detail. | P <input checked="" type="checkbox"/><br>F <input type="checkbox"/><br>N/A <input type="checkbox"/><br>N/T <input type="checkbox"/> |
| <b>5.5.8</b>   | <b>Meldungen des NA-Schutzes</b><br><i>Messages of the NS-protection</i>   |                          |   |
| <b>5.5.8.1</b> | <b>Prüfung</b><br><i>Test</i>  |                          |   |
|                | <p>Es ist durch Sichtprüfung festzustellen, dass die letzten 5 datierten Fehlermeldungen am NA Schutz ablesbar sind.</p> <p>Es ist zu prüfen, dass eine Unterbrechung der Versorgungsspannung 3 s nicht zum Verlust der Fehlermeldungen führt.</p> <p>Es ist nachzuprüfen, dass bei einem integrierten NA-Schutz die Einstellwerte der Schutzfunktion und die Fehlermeldungen über eine Datenschnittstelle auszu-lesen sind, sofern diese nicht direkt ablesbar sind.</p> <p><i>It must be determined by visual inspection that the last 5 dated error messages can be read on the NS-protection.</i></p> <p><i>It must be checked that an interruption of the supply voltage for 3 s does not lead to the loss of the error messages.</i></p> <p><i>It must be checked that, with integrated NS-protection, the setting values of the protective function and the error messages can be read out via a data interface if these cannot be read off directly.</i></p> | See appendix for detail. | P <input checked="" type="checkbox"/><br>F <input type="checkbox"/><br>N/A <input type="checkbox"/><br>N/T <input type="checkbox"/> |
| <b>5.5.8.2</b> | <b>Dokumentation</b><br><i>Documentation</i>   |                          |   |

**Prüfbericht-Nr.: 50336830 001 Attachment 1**  
*Test Report No.: 50336830 001 Attachment 1*

Seite 17 von 34  
Page 17 of 34

| Absatz | Anforderungen-Prüfungen | Messergebnisse-Bemerkungen | Bewertung  |
|--------|-------------------------|----------------------------|------------|
| Clause | Requirements-Tests      | Measuring results-Remarks  | Evaluation |

|                |  |                          |   |
|----------------|--|--------------------------|---|
|                | <p>Es ist mindestens festzuhalten:</p> <ul style="list-style-type: none"> <li>- die letzten 5 datierten Fehlermeldungen;</li> <li>- die Fehlermeldungen nach der Unterbrechung der Versorgungsspannung.</li> </ul> <p>Es ist anzugeben, ob die Werte direkt oder mithilfe einer Datenschnittstelle auslesebar sind.<br/>Sofern vorhanden, ist der Typ der Datenschnittstelle anzugeben.</p> <p><i>It shall at least be recorded:</i></p> <ul style="list-style-type: none"> <li>- the last 5 dated error messages;</li> <li>- the error messages after the interruption of the supply voltage.</li> </ul> <p><i>Indicate whether the values can be read out directly or via a data interface.</i></p> <p><i>If available, indicate the type of data interface.</i></p> | See appendix for detail. | P <input checked="" type="checkbox"/><br>F <input type="checkbox"/><br>N/A <input type="checkbox"/><br>N/T <input type="checkbox"/> |
| <b>5.5.9</b>   | <b>Bauliche Merkmale des NA-Schutzes</b>   |                          |   |
|                | <b>Structural characteristics of NS-protection</b>   |                          |   |
| <b>5.5.9.1</b> | <b>Allgemeines</b>   |                          |   |
|                | <b>General information</b>   |                          |   |
|                | <p>Diese Prüfungen dienen dem Nachweis der Anforderungen der VDE AR N 4105:2018-11, 6.5.2.</p> <p><i>These tests serve as proof of the requirements of VDE AR N 4105:2018-11, 6.5.2.</i></p>   | See appendix for detail. | P <input checked="" type="checkbox"/><br>F <input type="checkbox"/><br>N/A <input type="checkbox"/><br>N/T <input type="checkbox"/> |
| <b>5.5.9.2</b> | <b>Prüfung</b>   |                          |   |
|                | <b>Tests</b>   |                          |   |

Prüfbericht-Nr.: 50336830 001 Attachment 1  
Test Report No.: 50336830 001 Attachment 1

Seite 18 von 34  
Page 18 of 34

| Absatz | Anforderungen-Prüfungen | Messergebnisse-Bemerkungen | Bewertung  |
|--------|-------------------------|----------------------------|------------|
| Clause | Requirements-Tests      | Measuring results-Remarks  | Evaluation |

|                 |   |                          |   |
|-----------------|---|--------------------------|---|
|                 | <p>Es ist zu prüfen, ob der NA-Schutz mit einem Schutz vor unbefugtem Zugriff versehen ist, z.B.:</p> <ul style="list-style-type: none"> <li>- NA-Schutz plombierbar: durch Sichtprüfung, oder</li> <li>- NA-Schutz passwortgeschützt: Prüfung, auf Basis der Herstellerangaben, oder</li> <li>- andere geeignete Maßnahme.</li> </ul> <p>Es ist zu prüfen, ob U&gt; und die Zeitverzögerungen für U&lt; und U&lt;&lt; einstellbar sind. Es ist zu prüfen, ob alle anderen Schutzfunktionen, die in VDE-AR-N 4105:2018-11, Abschnitt 6.5 beschrieben sind, entweder fest oder durch einen zusätzlichen, separaten Schutz vor unbefugtem Zugriff geschützt sind.</p> <p><i>It must be checked whether the NS-protection is provided with protection against unauthorised access, e.g.:</i></p> <ul style="list-style-type: none"> <li>- <i>NS-protection can be sealed: by visual inspection, or</i></li> <li>- <i>NS-protection password-protected: Testing, based on the manufacturer's specifications, or</i></li> <li>- <i>other appropriate measure.</i></li> </ul> <p><i>Check whether U&gt; and the time delays for U&lt; and U&lt;&lt; can be set. Check whether all other protection functions described in VDE-AR-N 4105:2018-11, section 6.5 are either fixed or protected against unauthorised access by an additional, separate protection.</i></p> | See appendix for detail. | P <input checked="" type="checkbox"/><br>F <input type="checkbox"/><br>N/A <input type="checkbox"/><br>N/T <input type="checkbox"/> |
| <b>5.5.9.3</b>  | <b>Dokumentation</b><br><i>Documentation</i>  |                          |   |
|                 | <p>Es ist mindestens festzuhalten:</p> <ul style="list-style-type: none"> <li>- die Art und Form des Schutzes</li> <li>- Einstellbarkeit U&gt; und die Zeitverzögerungen für U&lt; und U&lt;&lt;</li> <li>- Ob alle anderen Schutzfunktionen entweder fest oder durch einen zusätzlichen, separaten Schutz vor unbefugtem Zugriff geschützt sind.</li> </ul> <p><i>It shall at least be recorded:</i></p> <ul style="list-style-type: none"> <li>- <i>the nature and form of the protection</i></li> <li>- <i>adjustability U&gt; and the time delays for U&lt; and U&lt;&lt;</i></li> <li>- <i>Whether all other protective functions are either fixed or protected against unauthorized access by an additional, separate protection.</i></li> </ul>  | See appendix for detail. | P <input checked="" type="checkbox"/><br>F <input type="checkbox"/><br>N/A <input type="checkbox"/><br>N/T <input type="checkbox"/> |
| <b>5.5.10</b>   | <b>Inselnetzerkennung</b><br><i>Island network detection</i>  |                          |   |
| <b>5.5.10.1</b> | <b>Allgemeines</b><br><i>General information</i>  |                          |   |

Prüfbericht-Nr.: 50336830 001 Attachment 1  
Test Report No.: 50336830 001 Attachment 1

Seite 19 von 34  
Page 19 of 34

| Absatz | Anforderungen-Prüfungen | Messergebnisse-Bemerkungen | Bewertung  |
|--------|-------------------------|----------------------------|------------|
| Clause | Requirements-Tests      | Measuring results-Remarks  | Evaluation |

|                 |  |                          |   |
|-----------------|--|--------------------------|---|
|                 | <p>Diese Prüfungen dienen dem Nachweis der Anforderungen der VDE AR N 4105:2018-11, 6.5.3.</p> <p><i>These tests serve as proof of the requirements of VDE AR N 4105:2018-11, 6.5.3.</i></p>   | See appendix for detail. | P <input checked="" type="checkbox"/><br>F <input type="checkbox"/><br>N/A <input type="checkbox"/><br>N/T <input type="checkbox"/> |
| <b>5.5.10.2</b> | <p><b>Passives Verfahren</b><br/><i>Passive procedure</i></p>  |                          |   |
|                 | <p>Das passive Verfahren wird durch den Spannungssteigerungs- und den Spannungsrückgangsschutz des NA-Schutzes realisiert.</p> <p>Anm.: Nur bei EZE ohne Umrichter oder bei einphasigen Erzeugungseinheiten mit Umrichter. Die dreiphasige Spannungsüberwachung ist auch bei einer baulichen Integration mehrerer einphasiger EZE, die in unterschiedliche Außenleiter einspeisen zulässig, solange die Ströme dieser EZE unabhängig voneinander geregelt werden, so dass sich beliebige Phasenlagen einstellen können.</p> <p><i>The passive process is realized by the voltage increase and voltage decrease protection of the NS-protection.</i></p> <p><i>Note: Only for PGU without inverter or for single-phase generation units with inverter. Three-phase voltage monitoring is also permissible in the case of structural integration of several single-phase PGUs which feed into different phase conductors, as long as the currents of these PGUs are controlled independently of each other so that any phase positions can be set.</i></p> | See appendix for detail. | P <input checked="" type="checkbox"/><br>F <input type="checkbox"/><br>N/A <input type="checkbox"/><br>N/T <input type="checkbox"/> |
| <b>5.5.10.3</b> | <p><b>Aktives Verfahren</b><br/><i>Active process</i></p>  |                          |   |
|                 | <p>Das aktive Verfahren wird geprüft nach DIN EN 62116 (VDE 0126-2)</p> <p>ANMERKUNG Die Prüfung von Geräten, die nicht am Netzsimulator geprüft werden können, ist in Beratung.</p> <p>Es ist mindestens festzuhalten:<br/>– Das Verfahren der Inselnetzerkennung</p> <p>The active process is tested according to DIN EN 62116 (VDE 0126-2).</p> <p>NOTE The testing of devices that cannot be tested on the network simulator is being advised.</p> <p><i>It shall at least be recorded:<br/>- The procedure of island network recognition</i></p>  | See appendix for detail. | P <input checked="" type="checkbox"/><br>F <input type="checkbox"/><br>N/A <input type="checkbox"/><br>N/T <input type="checkbox"/> |

**Prüfbericht-Nr.: 50336830 001 Attachment 1**  
*Test Report No.: 50336830 001 Attachment 1*

Seite 20 von 34  
 Page 20 of 34

|        |                           |                                  |                   |
|--------|---------------------------|----------------------------------|-------------------|
| Absatz | Anforderungen-Prüfungen   | Messergebnisse-Bemerkungen       | Bewertung         |
| Clause | <i>Requirements-Tests</i> | <i>Measuring results-Remarks</i> | <i>Evaluation</i> |

|              |   |
|--------------|---|
| <b>5.6</b>   | <b>Zuschaltbedingungen und Synchronisierung</b><br><b><i>Switching conditions and synchronization</i></b>   |
|              | Diese Prüfungen dienen dem Nachweis der Anforderungen der VDE AR N 4105:2018-11, 8.3.<br><i>These tests serve as proof of the requirements of VDE AR N 4105:2018-11, 8.3.</i> |
| <b>5.6.1</b> | <b>Allgemeines</b><br><b><i>General information</i></b>   |

Prüfbericht-Nr.: 50336830 001 Attachment 1  
Test Report No.: 50336830 001 Attachment 1

Seite 21 von 34  
Page 21 of 34

| Absatz | Anforderungen-Prüfungen | Messergebnisse-Bemerkungen | Bewertung  |
|--------|-------------------------|----------------------------|------------|
| Clause | Requirements-Tests      | Measuring results-Remarks  | Evaluation |

|  |   |                                 |  |
|--|---|---------------------------------|--|
|  | <p>Die Zuschaltung und die Synchronisierung werden durch mindestens eine geeignete Einrichtung ausgeführt bzw. überwacht. Diese Einrichtung kann in der Steuerung der EZE, im integrierten NA-Schutz oder im zentralen NA-Schutz realisiert sein und ist nach VDE-AR-N 4105:2018-11, 8.3 einzustellen und wie nachstehend zu prüfen:</p> <p>a) Der Hersteller hat dem Prüflaboratorium eine Dokumentation vorzulegen, welche Funktionen in welcher Komponente realisiert sind.</p> <p>b) Bei nicht zugeschalteter EZE wird die Prüfung durch die Veränderung der eingestellten Nennfrequenz und Nennspannung in der Steuerung durchgeführt. Alternativ dürfen auch andere Verfahren wie Netzsimulator oder ein Prüfstandtest für den Nachweis verwendet werden.</p> <p>Nach Auslösen des NA-Schutzes ist zu prüfen, dass sich die Anlage nur innerhalb der Toleranzbänder ((85 % <math>U_n \leq U \leq 110 \% U_n</math>) und (47,5 Hz <math>\leq f \leq 50,1</math> Hz)) und nach Verbleiben von Spannung und Frequenz innerhalb der Toleranzbänder frühestens nach 60 s zuschalten lässt.</p> <p>ANMERKUNG 1 Bei dem nachstehenden Ablauf sind die Messtoleranzen des NA-Schutzes berücksichtigt.</p> <p>ANMERKUNG 2 Der maximale Gradient der Wirkleistung bei Wiederschaltung wird in den Kapiteln 5.4.4 bis 5.4.7 überprüft</p> <p><i>The connection and synchronisation shall be carried out or monitored by at least one suitable device. This device can be implemented in the PGU control, in the integrated NS-protection or in the central NS-protection and must be set in accordance with VDE-AR-N 4105:2018-11, 8.3 and tested as described below:</i></p> <p><i>a) The manufacturer shall provide the testing laboratory with documentation of which functions are implemented in which component.</i></p> <p><i>b) If PGU is not switched on, the test is performed by changing the set nominal frequency and nominal voltage in the controller.</i></p> <p><i>Alternatively, other methods such as a mains simulator or a test bench test may also be used for verification. After triggering the NS-protection, it must be checked that the system can only be switched on within the tolerance bands ((85 % <math>U_n \leq U \leq 110 \% U_n</math>) and (47.5 Hz <math>\leq f \leq 50.1</math> Hz)) and after voltage and frequency have remained within the tolerance bands, at the earliest after 60 s. The system must not be switched on before the end of the test period.</i></p> <p><i>NOTE 1 The following procedure takes the measurement tolerances of the NS-protection into account.</i></p> <p><i>NOTE 2 The maximum gradient of the active power on reconnection is checked in chapters 5.4.4 to 5.4.7.</i></p> | <p>See appendix for detail.</p> | <p>P <input checked="" type="checkbox"/></p> <p>F <input type="checkbox"/></p> <p>N/A <input type="checkbox"/></p> <p>N/T <input type="checkbox"/></p> |
|--|---|---------------------------------|--|

**Prüfbericht-Nr.: 50336830 001 Attachment 1**  
*Test Report No.: 50336830 001 Attachment 1*

Seite 22 von 34  
 Page 22 of 34

|        |                         |                            |            |
|--------|-------------------------|----------------------------|------------|
| Absatz | Anforderungen-Prüfungen | Messergebnisse-Bemerkungen | Bewertung  |
| Clause | Requirements-Tests      | Measuring results-Remarks  | Evaluation |

|              |   |                          |   |
|--------------|---|--------------------------|---|
| <b>5.7</b>   | <b>Nachweis der PAV,E-Überwachung</b><br><i>Proof of PAV,E monitoring</i>   |                          |   |
| <b>5.7.1</b> | <b>Allgemeines</b><br><i>General information</i>  |                          |   |
|              | <p>Die Prüfung dient dem Nachweis der Anforderungen der VDE-AR-N 4105:2018-11, 5.5.2. Die PAV,E-Überwachung kann, muss aber nicht in der EZE integriert sein. Wird die PAV,E-Überwachung nicht als Einheit gebaut, sondern auf mehrere Geräte verteilt, ist die gesamte Wirkungskette analog zur Prüfung des NA-Schutzes inklusive der kommunikativen Kopplung zu prüfen.</p> <p><i>The test serves to verify the requirements of VDE-AR-N 4105:2018-11, 5.5.2. The PAV,E monitoring can, but does not have to, be integrated into the PGU. If the PAV,E monitoring is not built as a unit but distributed over several devices, the entire chain of effects must be tested analogously to the testing of the NA protection including the communicative coupling.</i></p> | See appendix for detail. | P <input checked="" type="checkbox"/><br>F <input type="checkbox"/><br>N/A <input type="checkbox"/><br>N/T <input type="checkbox"/> |
| <b>5.8</b>   | <b>Nachweis der dynamischen Netzstützung</b><br><i>Proof of dynamic network support</i>   |                          |   |
| <b>5.8.1</b> | <b>Allgemeines</b><br><i>General information</i>  |                          |   |



Prüfbericht-Nr.: 50336830 001 Attachment 1  
Test Report No.: 50336830 001 Attachment 1

Seite 23 von 34  
Page 23 of 34

| Absatz | Anforderungen-Prüfungen | Messergebnisse-Bemerkungen | Bewertung  |
|--------|-------------------------|----------------------------|------------|
| Clause | Requirements-Tests      | Measuring results-Remarks  | Evaluation |

|  |   |                                 |  |
|--|---|---------------------------------|--|
|  | <p>Diese Prüfungen dienen dem Nachweis der Anforderungen der VDE AR N 4105:2018-11, 5.7.3. Ziel dieser Prüfungen ist es, festzustellen, ob der Prüfling in der Lage ist, Spannungseinbrüche und Spannungsüberhöhungen unbeschadet zu durchfahren und sich entsprechend VDE-AR-N 4105:2018-11,5.7.3 zu verhalten. Der Prüfling kann eine Erzeugungseinheit (EZE) oder ein Speichersystem sein. Zum Prüfling zählen dabei:</p> <ul style="list-style-type: none"> <li>• Das Steuerungssystem und die Hilfsaggregate inklusive der in der EZE verbauten Eigenversorgung</li> <li>• Der Generator (Typ1 oder Asynchrongenerator) bzw. der Umrichter (Typ2 oder Speicher)</li> </ul> <p>Folgende EZE sind von der Prüfung ausgenommen:</p> <ul style="list-style-type: none"> <li>• Stirlinggeneratoren und Brennstoffzellen, die prinzipbedingt keine dynamische Netzstützung erbringen können;</li> <li>• Synchron- und Asynchrongeneratoren, die direkt oder über Umrichter gekoppelt sind, mit <math>PrE \leq 50 \text{ kW}</math>;</li> </ul> <p>Anmerkung: Die Hausgerätenorm DIN EN 60335 (VDE 0700) (alle Teile) fordert bei KWK-Anlagen eine Abschaltung der Brennstoffzufuhr bei Unter- und Überspannung.</p> <p>Das Durchfahren von mehreren aufeinander folgenden Netzfehlern ist nicht Gegenstand der Prüfung. Die im Folgenden aufgeführten Tests können aber für eine beliebige Folge von Netzfehlern mit fester oder variabler Pausenzeit wiederholt werden, um das Durchfahren von Mehrfach-Netzfehlern zu prüfen.</p> <p><i>These tests serve as proof of the requirements of VDE AR N 4105:2018-11, 5.7.3.</i></p> <p><i>The aim of these tests is to determine whether the test object is able to pass through voltage dips and voltage increases without damage and to behave in accordance with VDE-AR-N 4105:2018-11,5.7.3. The test object can be a power generation unit (PGU) or a storage system.</i></p> <p><i>The test item is considered to be one:</i></p> <ul style="list-style-type: none"> <li>- <i>The control system and the auxiliary units, including the self-supply installed in the PGU.</i></li> <li>- <i>The generator (type 1 or asynchronous generator) or the inverter (type 2 or accumulator)</i></li> </ul> <p><i>The following PGU are excluded from the examination:</i></p> <ul style="list-style-type: none"> <li>- <i>Stirling generators and fuel cells which, due to their principle, cannot provide dynamic grid support;</i></li> <li>- <i>Synchronous and asynchronous generators which are coupled directly or via converters, with <math>PrE \leq 50 \text{ kW}</math>;</i></li> </ul> <p><i>Note: The household appliance standard DIN EN 60335 (VDE 0700) (all parts) requires a switch-off of the fuel supply in CHP plants in the event of undervoltage or overvoltage.</i></p> <p><i>The passing through of several successive network faults is not the subject of the test. The tests listed below can, however, be repeated for any sequence of mains faults with fixed or variable pause times in order to test the passing through of multiple mains faults.</i></p> | <p>See appendix for detail.</p> | <p>P <input checked="" type="checkbox"/></p> <p>F <input type="checkbox"/></p> <p>N/A <input type="checkbox"/></p> <p>N/T <input type="checkbox"/></p> |
|--|---|---------------------------------|--|



**Prüfbericht-Nr.: 50336830 001 Attachment 1**  
*Test Report No.: 50336830 001 Attachment 1*

Seite 24 von 34  
Page 24 of 34

|        |                           |                                  |                   |
|--------|---------------------------|----------------------------------|-------------------|
| Absatz | Anforderungen-Prüfungen   | Messergebnisse-Bemerkungen       | Bewertung         |
| Clause | <i>Requirements-Tests</i> | <i>Measuring results-Remarks</i> | <i>Evaluation</i> |

|              |                                      |
|--------------|--------------------------------------|
| <b>5.8.2</b> | <b>Verfahren</b><br><i>Procedure</i> |
|--------------|--------------------------------------|

Prüfbericht-Nr.: 50336830 001 Attachment 1  
Test Report No.: 50336830 001 Attachment 1

Seite 25 von 34  
Page 25 of 34

| Absatz | Anforderungen-Prüfungen | Messergebnisse-Bemerkungen | Bewertung  |
|--------|-------------------------|----------------------------|------------|
| Clause | Requirements-Tests      | Measuring results-Remarks  | Evaluation |

|  |  |                                 |   |
|--|--|---------------------------------|---|
|  | <p>Der Prüfling wird an ein Netz mit nachgeschalteter Prüfeinrichtung (oder einen Netzsimulator mit nachgeschalteter Netznachbildung) angeschlossen. Diese Prüfeinrichtung muss in der Lage sein, den/die entsprechende/n Spannungseinbrüche/-überhöhungen, auf der Prüflingsseite nachbilden können. Alle Anforderungen an die Prüfeinrichtungen sind im Anhang A aufgeführt. Die korrekte Parametrierung der Prüfeinrichtung, um die jeweiligen Spannungseinbrüche/-überhöhungen entsprechend Tabelle 17 und Tabelle 18 zu erhalten, ist für jeden Test durch einen Leerlaufversuch zu kontrollieren (jeweils separat symmetrisch, unsymmetrisch). Der jeweils einzustellende Wert ist für Spannungseinbrüche die jeweilig resultierende, kleinste Leiter-Neutralleiter-Spannung. Für Spannungsüberhöhungen ist der einzustellende Wert die jeweilig resultierende, auf den Nennwert bezogene, größte Leiter-Neutralleiter-Spannung. Die Tests sind dabei jeweils bei einer Spannung im Bereich von <math>U_n \pm 5\% U_n</math> zu starten. Bezugspunkt für die dynamische Netzstützung der EZE oder des Speichersystems sind die netzseitigen Anschlussklemmen des Prüflings. Es ist bei Volllast (<math>PrE \pm 2\% PrE</math>) sowie im Teillastbereich von 0,2 PrE bis 0,6 PrE zu testen. Referenzwert ist die gemessene Wirkleistung als 10-s-Mittelwert unmittelbar vor dem/der Spannungseinbruch/-überhöhung. Alle Tests 1 bis 6 aus Tabelle 17 bzw. die Tests 1 bis 7 aus Tabelle 18 müssen sowohl symmetrisch (Fehlerbild A) wie auch unsymmetrisch (gemäß Fehlerbild D) durchgeführt werden (nach Bollen, siehe Anhang).</p> <p><i>The test object is connected to a network with downstream test equipment (or a network simulator with downstream network simulation). This test device shall be capable of simulating the corresponding voltage dip/surges as on the test item side. All requirements for the test equipment are listed in Annex A. For each test, the correct parameterization of the test equipment in order to obtain the respective voltage dips / increases in accordance with Table 17 and Table 18 shall be checked by a no-load test (each separately symmetrical, asymmetrical). For voltage dips, the value to be set in each case is the resulting smallest conductor-neutral conductor voltage. For voltage increases, the value to be set is the respective resulting largest conductor-neutral conductor voltage related to the nominal value. The tests must be started with a voltage in the range of <math>U_n \pm 5\% U_n</math>. The reference point for the dynamic network support of the PGU or the storage system are the network-side terminals of the test item. It must be tested at full load (<math>PrE \pm 2\% PrE</math>) and in the partial load range from 0.2 PrE to 0.6 PrE. The reference value is the measured active power as an average of 10 s immediately before the voltage dip/exaggeration. All tests 1 to 6 from Table 17 or tests 1 to 7 from Table 18 must be performed both symmetrically (error pattern A) and asymmetrically (according to error pattern D) (according to Bollen, see</i></p> | <p>See appendix for detail.</p> | <p>P <input checked="" type="checkbox"/><br/>F <input type="checkbox"/><br/>N/A <input type="checkbox"/><br/>N/T <input type="checkbox"/></p> |
|--|--|---------------------------------|---|

**Prüfbericht-Nr.: 50336830 001 Attachment 1**  
*Test Report No.: 50336830 001 Attachment 1*

Seite 26 von 34  
Page 26 of 34

| Absatz | Anforderungen-Prüfungen | Messergebnisse-Bemerkungen | Bewertung  |
|--------|-------------------------|----------------------------|------------|
| Clause | Requirements-Tests      | Measuring results-Remarks  | Evaluation |

|              |   |  |   |
|--------------|---|--|---|
| <b>5.9</b>   | <b>Prüfung von Hilfsaggregaten</b><br><i>Testing of auxiliary aggregates</i>  |  |   |
| <b>5.9.1</b> | <b>Allgemeines</b><br><i>General information</i>  |  |   |
|              | Hilfsaggregate, die nicht bei den FRT-Tests gemäß Abschnitt 5.8 mitgetestet wurden, können nach dem hier beschriebenen Verfahren überprüft werden.<br><br><i>Auxiliary power units not included in the FRT tests according to section 5.8 can be tested according to the procedure described here.</i>  |  | P <input type="checkbox"/><br>F <input type="checkbox"/><br>N/A <input checked="" type="checkbox"/><br>N/T <input type="checkbox"/> |
| <b>6</b>     | <b>Hinweise zum Zertifizierungsverfahrens</b><br><i>Notes on the certification procedure</i>  |  |   |
| <b>6.1</b>   | <b>Allgemeines</b><br><i>General information</i>  |  |   |
|              | Die allgemein übliche Form der Nachweisführung ist die Vorlage von Zertifikaten beim Netzbetreiber. Wenn Zertifikate erstellt werden, dann werden diese nach dem Zertifizierungsprogramm FGW TR8:2019-02 erstellt. Die Bewertung der Messergebnisse erfolgt nach den Bewertungskriterien der VDE V 0124-100.<br><br><i>The generally accepted form of verification is the submission of certificates to the grid operator. When certificates are issued, they are issued in accordance with the certification program FGW TR8:2019-02. The evaluation of the measurement results is carried out according to the evaluation criteria of VDE V 0124-100.</i> |  | P <input checked="" type="checkbox"/><br>F <input type="checkbox"/><br>N/A <input type="checkbox"/><br>N/T <input type="checkbox"/> |
| <b>6.2</b>   | <b>Übertragbarkeit von Messungen</b><br><i>Transferability of measurements</i>  |  |   |

Prüfbericht-Nr.: 50336830 001 Attachment 1  
Test Report No.: 50336830 001 Attachment 1

Seite 27 von 34  
Page 27 of 34

| Absatz | Anforderungen-Prüfungen | Messergebnisse-Bemerkungen | Bewertung  |
|--------|-------------------------|----------------------------|------------|
| Clause | Requirements-Tests      | Measuring results-Remarks  | Evaluation |

|  |   |   |  |
|--|---|---|--|
|  | <p>Vermessungsergebnisse können zwischen Erzeugungseinheiten/ Komponenten übertragen werden, wenn sichergestellt werden kann, dass die eingesetzte Software zur Steuerung/ Regelung der Erzeugungseinheit/ Komponente identisch beziehungsweise gleichwertig ist und die Hardware technisch gleichwertig ist. Dieses ist durch die Zertifizierungsstelle mit Hilfe der Hersteller Dokumentation zu prüfen. Der Hersteller hat ebenfalls eine Abschätzung bzgl. möglicher Unterschiede abzugeben.</p> <p>Der Übertragbarkeitsbereich wird nach den Regeln der VDE-AR-N 4110:2018-11 Kapitel 11.2.1 bestimmt. Ergebnisse der Vermessung einer Erzeugungseinheit können in Summe oder in Teilen auf andere Erzeugungseinheiten übertragen werden, wenn</p> <ol style="list-style-type: none"> <li>1) die Ausführung und die für die elektrischen Eigenschaften maßgebende Regelungstechnik einschließlich der eingesetzten Software in diesen Erzeugungseinheiten technisch gleichwertig sind und</li> <li>2) die Ergebnisse für die kleinste und größte Leistungsvariante unter Berücksichtigung von 1) vorliegen oder alternativ die Nennleistung der zu zertifizierenden Erzeugungseinheit zwischen dem <math>1/\sqrt{10}</math>-fachen und <math>\sqrt{10}</math>-fachen (bei Typ-1-Anlagen) bzw. zwischen dem <math>1/\sqrt{10}</math>-fachen und 2-fachen (bei Typ-2-Anlagen) der Nennleistung der vermessenen Erzeugungseinheit liegt.</li> </ol> <p><i>Measurement results can be transferred between generation units/components if it can be ensured that the software used to control the generation unit/component is identical or equivalent and that the hardware is technically equivalent. This must be checked by the certification body with the help of the manufacturer's documentation. The manufacturer shall also provide an estimate of possible differences.</i></p> <p><i>The range of transferability is determined in accordance with the regulations of VDE-AR-N 4110:2018-11 Chapter 11.2.1. Results of the measurement of a generation unit can be transferred in sum or in parts to other generation units, if</i></p> <ol style="list-style-type: none"> <li>1) the design and the control technology relevant for the electrical properties, including the software used, are technically equivalent in these generation units, and</li> <li>2) the results for the smallest and largest power variant are available taking into account 1) or alternatively the nominal power of the generation unit to be certified is between <math>1/\sqrt{10}</math> and <math>\sqrt{10}</math> times (for type 1 plants) or between <math>1/\sqrt{10}</math> and 2 times (for type 2 plants) the nominal power of the measured generation unit.</li> </ol> | <p>Unless otherwise specified, all tests were implemented on model EVT600 to represent other family models.</p> | <p>P <input checked="" type="checkbox"/></p> <p>F <input type="checkbox"/></p> <p>N/A <input type="checkbox"/></p> <p>N/T <input type="checkbox"/></p> |
|--|---|---|--|

**Prüfbericht-Nr.: 50336830 001 Attachment 1**  
*Test Report No.: 50336830 001 Attachment 1*

Seite 28 von 34  
Page 28 of 34

| Absatz | Anforderungen-Prüfungen | Messergebnisse-Bemerkungen | Bewertung  |
|--------|-------------------------|----------------------------|------------|
| Clause | Requirements-Tests      | Measuring results-Remarks  | Evaluation |

|            |  |
|------------|--|
| <b>6.3</b> | <b>Alternative Form des FRT-Nachweises</b><br><i>Alternative form of FRT detection</i> |
|------------|--|

Prüfbericht-Nr.: 50336830 001 Attachment 1  
Test Report No.: 50336830 001 Attachment 1

Seite 29 von 34  
Page 29 of 34

| Absatz | Anforderungen-Prüfungen | Messergebnisse-Bemerkungen | Bewertung  |
|--------|-------------------------|----------------------------|------------|
| Clause | Requirements-Tests      | Measuring results-Remarks  | Evaluation |

|  |  |  |  |
|--|--|--|--|
|  | <p>Standardmäßig ist der Nachweis durch Messungen zu erbringen. Eine alternative Form der Nachweisführung ist von der TAR nicht vorgesehen und auch nicht notwendig, da die fraglichen Leistungen stets direkt getestet werden können. Falls dies in begründeten Fällen dennoch nicht möglich ist, so kann der FRT-Nachweis für Typ 1 EZE alternativ per rechnerischer Simulation mit einem Synchronmaschinenmodell durchgeführt werden. Dies erfolgt unter direkter Bezugnahme auf die Festlegungen der 4110 und erfordert mindestens die folgenden Schritte:</p> <ol style="list-style-type: none"> <li>1) Erstellung eines Anlagenzertifikates „C“ nach FGW TR8:2019-02 inklusive einem vorläufigen Simulationsmodell nach FGW TR 4:2019-02.</li> <li>2) Inbetriebsetzung und Vermessung nach der EZA nach FGW TR 3:2018-09.</li> <li>3) Erstellung einer erweiterten Konformitätserklärung einschließlich der Optimierung des erstellten Simulationsmodells nach FGW TR 4:2019-02.</li> <li>4) Vorläufiger Betrieb der EZA unter Monitoring mit Störschreibern. Melde- und Nachbesserungspflicht bei Netzereignissen (mindestens 5 Jahre Überwachung durch die Zertifizierungsstelle).</li> </ol> <p>Die Hilfsaggregate der EZE sind separat auf Unter- und Überspannung zu prüfen. Die Prüfung der Hilfsaggregate ist nach Kapitel 5.9 durchzuführen.</p> <p><i>By default, proof shall be provided by measurements. An alternative form of verification is not provided for by the TAR and is also not necessary, since the services in question can always be tested directly. If this is still not possible in justified cases, the FRT verification for type 1 PGU can alternatively be carried out by mathematical simulation with a synchronous machine model. This is done with direct reference to the specifications of the 4110 and requires at least the following steps:</i></p> <ol style="list-style-type: none"> <li><i>1) Creation of a plant certificate "C" according to FGW TR8:2019-02 including a preliminary simulation model according to FGW TR 4:2019-02.</i></li> <li><i>2) Commissioning and surveying after development cooperation according to FGW TR 3:2018-09.</i></li> <li><i>3) Preparation of an extended declaration of conformity including the optimisation of the simulation model according to FGW TR 4:2019-02.</i></li> <li><i>4) Provisional operation of the development cooperation under monitoring with fault recorders. Obligation to report and rectify grid events (at least 5 years monitoring by the certification body).</i></li> </ol> <p><i>The auxiliary units of the PGU must be tested separately for undervoltage and overvoltage. The auxiliary power units shall be tested in accordance with Chapter 5.9.</i></p> |  | <p>P <input type="checkbox"/></p> <p>F <input type="checkbox"/></p> <p>N/A <input checked="" type="checkbox"/></p> <p>N/T <input type="checkbox"/></p> |
|--|--|--|--|

Prüfbericht-Nr.: 50336830 001 Attachment 1  
Test Report No.: 50336830 001 Attachment 1

Seite 30 von 34  
Page 30 of 34

| Absatz | Anforderungen-Prüfungen | Messergebnisse-Bemerkungen | Bewertung  |
|--------|-------------------------|----------------------------|------------|
| Clause | Requirements-Tests      | Measuring results-Remarks  | Evaluation |

|              |  |                          |   |
|--------------|--|--------------------------|---|
| <b>A</b>     | <b>Anhang A</b><br><b>Annex A</b>  |                          |   |
| <b>A.1</b>   | <b>Anhang FRT (normativ)</b><br><b>Annex FRT (normative)</b>   |                          |   |
| <b>A.1.1</b> | <b>Anforderungen an den Prüfstand für FRT Tests</b><br><b>Requirements for the test bench for FRT tests</b>  |                          |   |
|              | <p>The generated voltage dips and voltage increases shall meet the following requirements:</p> <ul style="list-style-type: none"> <li>- The effective mains impedance from the PGU point of view (with voltage divider principle: with connected longitudinal impedance) must meet the following criteria: <ul style="list-style-type: none"> <li>- The short-circuit power at the PGU before and after the fault must be between 10x Sn and 30x Sn.</li> <li>- R/X 0,3 - 3 (for the impedances used in the test equipment)</li> <li>- The test equipment and, if necessary, the mains simulator must be able to conduct the maximum current of the test object both in the generator and in the motor area. The energy consumption must be designed for the occurring surge short-circuit current iP (according to IEC 60909). iP of the test types is very different. are standard values: <ul style="list-style-type: none"> <li>- for inverter-coupled systems approx. 2.2 Ir,</li> <li>- for directly coupled asynchronous or synchronous machines approx. 7 Ir.</li> </ul> </li> <li>- For symmetrical and asymmetrical voltage dips and voltage increases, the error form A and D as shown in Fig. 8 with the phase positions of the voltages as shown in Table 21 must be observed, taking into account the switching group effect. The diagrams show conductor-neutral conductor voltages.</li> </ul> </li> </ul> <p>Note: In the case of a medium-voltage side, two-pole fault without ground contact (conductor-conductor voltages: fault pattern D) upstream of a Dy transformer, fault pattern D results on the undervoltage side of the transformer when the conductor-neutral conductor voltages are considered.</p> <ul style="list-style-type: none"> <li>- The edge steepness of the voltage must correspond to that of a circuit-breaker when a fault occurs and when a fault is declared. <ul style="list-style-type: none"> <li>A change in the instantaneous voltage from 90 % to 10 % of the pre-fault voltage should take place within a period of max. 4 ms for UVRT.</li> </ul> </li> <li>- The requirements for the waveform of the test voltage are to be tested within the scope of the idle tests. The test voltage must lie within the tolerances shown in Fig. 9 for voltage dip tests or in Fig. 10 for overvoltage tests.</li> </ul> | See appendix for detail. | P <input checked="" type="checkbox"/><br>F <input type="checkbox"/><br>N/A <input type="checkbox"/><br>N/T <input type="checkbox"/> |



Prüfbericht-Nr.: 50336830 001 Attachment 1  
Test Report No.: 50336830 001 Attachment 1

Seite 31 von 34  
Page 31 of 34

| Absatz | Anforderungen-Prüfungen | Messergebnisse-Bemerkungen | Bewertung  |
|--------|-------------------------|----------------------------|------------|
| Clause | Requirements-Tests      | Measuring results-Remarks  | Evaluation |

|              |  |                          |   |
|--------------|--|--------------------------|---|
| <b>A.2</b>   | <b>Beispiele möglicher Prüfstände für UVRT (informativ)</b><br><i>Examples of possible test benches for UVRT (informative)</i>   |                          |   |
| <b>A.2.1</b> | <b>Netzsimulator</b><br><i>Network simulator</i>   |                          |   |
|              | <p>Netzsimulatoren setzen sich im Wesentlichen aus einer niederohmigen Spannungsquelle sowie einer Netznachbildung zusammen, mit der dem Prüfling geeignete Impedanzen präsentiert werden können. Im Gegensatz zu Prüfeinrichtungen mit Kurzschlusszweig muss hier der Netzsimulator die zwei- und dreiphasigen Fehler nachbilden. Zum Betrieb des Prüflings wird darüber hinaus entweder eine rotierende Antriebseinheit oder eine DC- oder AC-Quelle benötigt, die die entsprechende (mechanische oder elektrische) Leistung zur Durchführung der unterschiedlichen Tests bereitstellt. Die Antriebseinheit oder Quelle muss eine Regelung aufweisen, mit der die für die Tests notwendigen stationären und dynamischen Betriebsbedingungen nachgebildet werden können.</p> <p><i>Network simulators essentially consist of a low impedance voltage source and a network simulation with which suitable impedances can be presented to the test item. In contrast to test equipment with a short-circuit branch, the network simulator has to simulate the two-phase and three-phase faults. In addition, either a rotating drive unit or a DC or AC source is required to operate the test item, which provides the appropriate (mechanical or electrical) power to perform the various tests. The drive unit or source must have a controller that can replicate the steady-state and dynamic operating conditions required for the tests.</i></p> | See appendix for detail. | P <input checked="" type="checkbox"/><br>F <input type="checkbox"/><br>N/A <input type="checkbox"/><br>N/T <input type="checkbox"/> |
| <b>A.2.2</b> | <b>Kurzschlussimulator</b><br><i>Short-circuit simulator</i>   |                          |   |
|              | <p>Ein Kurzschlussimulator nach dem Spannungsteilerprinzip verfügt über Vor- und Kurzschlussdrossel. Die Kurzschlussdrossel wird durch den Schalter aktiviert. Dieser Schalter kann ein mechanischer Leistungsschalter oder ein elektronischer Schalter sein, wenn die Schalteigenschaften mit einem Mittelspannungsleistungsschalter vergleichbar sind.</p> <p><i>A short-circuit simulator based on the voltage divider principle has a pre-circuit and short-circuit choke. The short-circuit choke is activated by the switch. This switch can be a mechanical circuit breaker or an electronic switch if the switching characteristics are comparable to a medium-voltage circuit breaker.</i></p>  |                          | P <input type="checkbox"/><br>F <input type="checkbox"/><br>N/A <input checked="" type="checkbox"/><br>N/T <input type="checkbox"/> |



Prüfbericht-Nr.: 50336830 001 Attachment 1  
Test Report No.: 50336830 001 Attachment 1

Seite 32 von 34  
Page 32 of 34

| Absatz | Anforderungen-Prüfungen | Messergebnisse-Bemerkungen | Bewertung  |
|--------|-------------------------|----------------------------|------------|
| Clause | Requirements-Tests      | Measuring results-Remarks  | Evaluation |

|              |   |                          |   |
|--------------|---|--------------------------|---|
| <b>A.3</b>   | <b>Beispiele möglicher Prüfstände OVRT (informativ)</b><br><i>Examples of possible test benches OVRT (informative)</i>  |                          |   |
| <b>A.3.1</b> | <b>Liste von Prüfeinrichtungen</b><br><i>List of test facilities</i>  |                          |   |
|              | <ul style="list-style-type: none"> <li>• Netzsimulator (Umrichtersystem)</li> <li>• Transformatorbasierte Prüfeinrichtungen (Auto- oder Bypass-Transformatorsystem)</li> <li>• kondensatorbasierte Prüfeinrichtung.</li> </ul> <p>- Mains simulator (inverter system)<br/>- Transformer-based test equipment (auto- or bypass transformer system)<br/>- capacitor-based testing device.</p>   | See appendix for detail. | P <input checked="" type="checkbox"/><br>F <input type="checkbox"/><br>N/A <input type="checkbox"/><br>N/T <input type="checkbox"/> |
| <b>A.3.2</b> | <b>Transformatorbasierte Prüfeinrichtung</b><br><i>Transformer based test apparatus</i>   |                          |   |
|              | <p>Transformatorbasierte Prüfeinrichtungen haben einen Transformator mit geeignet abgestuften Abgriffen als Basis. Durch den Wechsel auf eine andere Kombination der Abgriffe werden die Fehlerform sowie die Einbruchtiefe bestimmt. Die Einbruchsdauer wird durch eine Schalteinheit festgelegt, die zwischen den verschiedenen Abgriffen umschaltet und einen kontinuierlichen Stromfluss nach Anhang A. 1.1 des Prüflings gewährleistet.</p> <p><i>Transformer-based test facilities have a transformer with suitably graded taps as a base. By switching to a different combination of the taps, the type of fault and the burglary depth are determined. The burglary duration is determined by a switching unit which switches between the different taps and ensures a continuous current flow according to Appendix A. 1.1 of the test item.</i></p> |                          | P <input type="checkbox"/><br>F <input type="checkbox"/><br>N/A <input checked="" type="checkbox"/><br>N/T <input type="checkbox"/> |
| <b>A.3.3</b> | <b>Kondensatorbasierte Prüfeinrichtung</b><br><i>Capacitor-based testing device</i>   |                          |   |

Prüfbericht-Nr.: 50336830 001 Attachment 1  
Test Report No.: 50336830 001 Attachment 1

Seite 33 von 34  
Page 33 of 34

| Absatz | Anforderungen-Prüfungen | Messergebnisse-Bemerkungen | Bewertung  |
|--------|-------------------------|----------------------------|------------|
| Clause | Requirements-Tests      | Measuring results-Remarks  | Evaluation |

|  |   |  |  |
|--|---|--|--|
|  | <p><i>The example below shows a capacitor-based test setup for an overvoltage ride-through. By connecting a capacitor to a coil, a series resonant circuit can be formed which generates an overvoltage. In this way, overvoltage situations in networks (e.g. load shedding, Ferranti effect) can be realistically simulated.</i></p> <p><i>As already described above for the undervoltage ride-through, the effect of the test sequence for the upstream network is limited by the resistor XSR.</i></p> <p><i>The XSR resistor should be variable and selected so that the overvoltage generated for the test does not create an undesirable situation in the upstream network and at the same time does not significantly influence the transient response of the PGU.</i></p> <p><i>A bypass for XSR (LS1) can be switched before and after the voltage rise triggered by actuating LS2. The overvoltage is triggered by connecting the resistor of CL and Rd via switch LS2.</i></p> <p><i>The values of XSR, CL and Rd should be selected so that the voltage specified for the test is generated when the test item is not connected. The values of XSR, CL and Rd as used in the test shall be specified in the test apparatus description, together with the no-load short-circuit ratio of mains and test apparatus.</i></p> <p><i>Switches LS1 and LS2 shall be used to control the duration of the voltage rise. These may, for example, be mechanical switches. If other switching devices are used, the behaviour of mechanical switches with respect to closing time and opening time is regarded as a reference to be observed.</i></p> |  | <p>P <input type="checkbox"/></p> <p>F <input type="checkbox"/></p> <p>N/A <input checked="" type="checkbox"/></p> <p>N/T <input type="checkbox"/></p> |
|--|---|--|--|

**Prüfbericht-Nr.: 50336830 001 Attachment 1**  
*Test Report No.: 50336830 001 Attachment 1*

Seite 34 von 34  
*Page 34 of 34*

**ZUSATZ-DOKUMENTATION**  
***ADDITIONAL DOCUMENTATION***









See following pages.

|  |  |
|--|--|
| <p><b>TEST REPORT</b><br/> <b>E DIN VDE V 0124-100/09.19</b><br/> <b>Grid-integration of generator plants-</b><br/> <b>Low-voltage-</b><br/> <b>Test requirements for generator units to be connected to and operated in parallel</b><br/> <b>with low-voltage distribution networks</b></p>   |  |
| Report Reference No.....   | 50336830 001 Attachment 1  |
| Tested by (name + signature) .....   | See test report 50336830 001 .....   |
| Witnessed by (name + signature) :  | -- .....   |
| Supervised by (name + signature) .....   | -- .....   |
| Approved by (name + signature)..:  | See test report 50336830 001 .....   |
| Date of issue .....  | See test report 50336830 001   |
| Testing Laboratory .....   | TÜV Rheinland (Shanghai) Co., Ltd.   |
| Address.....   | No. 177, Lane 777, Guangzhong West Road, Jing'an District, Shanghai, China                                       |
| Testing location/ address.....   | TÜV Rheinland (Shanghai) Co., Ltd.<br>No. 177, Lane 777, Guangzhong West Road, Jing'an District, Shanghai, China |
| Applicant's name.....  | See test report 50336830 001   |
| Address.....   | See test report 50336830 001   |
| Test specification:  |  |
| Standard.....  | E DIN VDE V 0124-100/09.19   |
| Test procedure .....   | AK   |
| Non-standard test method.....  | N/A  |
| Test Report Form No.....   | TRF_VDE_0124-100_V.1   |
| Test Report Form(s) Originator.....  | TÜV Rheinland Group  |
| Master TRF.....  | 2019-09  |
| <p><b>Copyright © TÜV Rheinland LGA Products GmbH · Tillystrasse 2 · D-90431 Nürnberg, Deutschland.</b><br/> <b>All rights reserved.</b><br/>                 This publication may be reproduced in whole or in part for non-commercial purposes as long as the TÜV Rheinland LGA Products GmbH is acknowledged as copyright owner and source of the material. TÜV Rheinland LGA Products GmbH takes no responsibility for and will not assume liability for damages resulting from the reader's interpretation of the reproduced material due to its placement and context.<br/>                 If this Test Report Form is used by non- TÜV Rheinland LGA Products GmbH members, the TÜV Rheinland logo shall be removed.<br/> <b>This report is not valid as a Test Report unless signed by TÜV Rheinland LGA Products GmbH.</b></p> |  |
| Test item description.....   | Grid Connected PV Inverter   |
| Trade Mark .....   | ENVERTECH  |
| Manufacturer .....   | Same as applicant.   |
| Model/Type reference.....  | EVT300, EVT360, EVT560, EVT600, EVT660, EVT720, EVT1200  |
| Ratings.....   | See general products information and refer to marking label.   |

























































List of Attachments (including a total number of pages in each attachment):

N/A

Copy of marking plate:

|                                       |                |   |         |   |  |
|---------------------------------------|----------------|---|---------|---|--|
| <b>PV Microinverter</b>               |                | <b>Model: EVT300</b>                              |         |    |  |
| Operating range (Vdc):                | 18V~54V        | Normal Voltage (Vac):                             | 230V    | Zhejiang Envertech Corporation LTD.<br>www.envertec.com                               |  |
| MPPT Voltage Range (Vdc):             | 24V~45V        | Current (Max. continuous) (A):                    | 1.36A   | VDE-AR-N 4105,VDE0126-1-1,AS4777  |  |
| Max. DC input (Vdc):                  | 54V            | Frequency (Hz):                                   | 50Hz    | EN50438,EN62109,UTE C15-712-1   |  |
| Max. input continuous current (A):    | 12A            | Power Factor Range:                               | +/-0.95 | IEC61727,IEC60068,IEC61683  |  |
| Max. input short-circuit current (A): | 15A            | Maximum units per branch:                         | 20      |    |  |
| Ingress protection (IP):              | IP67           | Protective class:                                 | Class I |   |  |
| Power (Max. continuous) (W):          | 300W           | Overvoltage category: OVC III(AC Main),OVC II(PV) |         |   |  |
| Temperature(°C):                      | -40°C to +85°C |   |         |   |  |
| <b>PV Microinverter</b>               |                | <b>Model: EVT360</b>                              |         |    |  |
| Operating range (Vdc):                | 18V~54V        | Normal Voltage (Vac):                             | 230V    | Zhejiang Envertech Corporation LTD.<br>www.envertec.com                               |  |
| MPPT Voltage Range (Vdc):             | 24V~45V        | Current (Max. continuous) (A):                    | 1.63A   | VDE-AR-N 4105,VDE0126-1-1,AS4777  |  |
| Max. DC input (Vdc):                  | 54V            | Frequency (Hz):                                   | 50Hz    | EN50438,EN62109,UTE C15-712-1   |  |
| Max. input continuous current (A):    | 12A            | Power Factor Range:                               | +/-0.95 | IEC61727,IEC60068,IEC61683  |  |
| Max. input short-circuit current (A): | 15A            | Maximum units per branch:                         | 15      |   |  |
| Ingress protection (IP):              | IP67           | Protective class:                                 | Class I |   |  |
| Power (Max. continuous) (W):          | 380W           | Overvoltage category: OVC III(AC Main),OVC II(PV) |         |   |  |
| Temperature(°C):                      | -40°C to +85°C |   |         |   |  |
| <b>PV Microinverter</b>               |                | <b>Model: EVT560</b>                              |         |  |  |
| Operating range (Vdc):                | 18V~54V        | Normal Voltage (Vac):                             | 230V    | Zhejiang Envertech Corporation LTD.<br>www.envertec.com                               |  |
| MPPT Voltage Range (Vdc):             | 24V~45V        | Current (Max. continuous) (A):                    | 2.54A   | VDE-AR-N 4105,VDE0126-1-1,AS4777  |  |
| Max. DC input (Vdc):                  | 54V            | Frequency (Hz):                                   | 50Hz    | EN50438,EN62109,UTE C15-712-1   |  |
| Max. input continuous current (A):    | 12AX2          | Power Factor Range:                               | +/-0.95 | IEC61727,IEC60068,IEC61683  |  |
| Max. input short-circuit current (A): | 15A            | Maximum units per branch:                         | 10      |  |  |
| Ingress protection (IP):              | IP67           | Protective class:                                 | Class I |   |  |
| Power (Max. continuous) (W):          | 560W           | Overvoltage category: OVC III(AC Main),OVC II(PV) |         |   |  |
| Temperature(°C):                      | -40°C to +85°C |   |         |   |  |
| <b>PV Microinverter</b>               |                | <b>Model:EVT600</b>                               |         |  |  |
| Operating range (Vdc):                | 18V~54V        | Normal Voltage (Vac):                             | 230V    | Zhejiang Envertech Corporation LTD.<br>www.envertec.com                               |  |
| MPPT Voltage Range (Vdc):             | 24V~45V        | Current (Max. continuous) (A):                    | 2.72A   | VDE-AR-N 4105,VDE0126-1-1,AS4777  |  |
| Max. DC input (Vdc):                  | 54V            | Frequency (Hz):                                   | 50Hz    | EN50438,EN62109,UTE C15-712-1   |  |
| Max. input continuous current (A):    | 12AX2          | Power Factor Range:                               | +/-0.95 | IEC61727,IEC60068,IEC61683  |  |
| Max. input short-circuit current (A): | 15A            | Maximum units per branch:                         | 9       |  |  |
| Ingress protection (IP):              | IP67           | Protective class:                                 | Class I |   |  |
| Power (Max. continuous) (W):          | 600W           | Overvoltage category: OVC III(AC Main),OVC II(PV) |         |   |  |
| Temperature(°C):                      | -40°C to +85°C |   |         |   |  |



|   |  |  |         |                       |      |                           |         |                                |       |                      |     |                 |      |                                    |       |                     |         |                                       |     |                           |   |                          |      |                   |         |                              |       |  |  |                  |                |  |  |   |                            |   |   |   |   |
|---|--|--|---------|-----------------------|------|---------------------------|---------|--------------------------------|-------|----------------------|-----|-----------------|------|------------------------------------|-------|---------------------|---------|---------------------------------------|-----|---------------------------|---|--------------------------|------|-------------------|---------|------------------------------|-------|--|--|------------------|----------------|--|--|---|----------------------------|---|---|---|---|
| <br><b>ENVERTECH</b><br>PV Microinverter<br>Model: EVT660<br>Zhejiang Envertech Corporation Ltd.<br>www.envertec.com   | <table style="width: 100%; border-collapse: collapse;"> <tr> <td style="width: 33%;">Operating range (Vdc):</td> <td style="width: 33%;">18V~54V</td> <td style="width: 33%;">Normal Voltage (Vac):</td> <td style="width: 33%;">230V</td> </tr> <tr> <td>MPPT Voltage Range (Vdc):</td> <td>24V~45V</td> <td>Current (Max. continuous) (A):</td> <td>3A</td> </tr> <tr> <td>Max. DC input (Vdc):</td> <td>54V</td> <td>Frequency (Hz):</td> <td>50Hz</td> </tr> <tr> <td>Max. input continuous current (A):</td> <td>12Ax2</td> <td>Power Factor Range:</td> <td>+/-0.95</td> </tr> <tr> <td>Max. input short-circuit current (A):</td> <td>15A</td> <td>Maximum units per branch:</td> <td>8</td> </tr> <tr> <td>Ingress protection (IP):</td> <td>IP67</td> <td>Protective class:</td> <td>Class I</td> </tr> <tr> <td>Power (Max. continuous) (W):</td> <td>660W</td> <td>Overvoltage category: OVC III (AC Main), OVC II (PV)</td> <td></td> </tr> <tr> <td>Temperature(°C):</td> <td colspan="3">-40°C to +65°C</td> </tr> </table><br><table style="width: 100%; border-collapse: collapse;"> <tr> <td style="width: 30%; text-align: center;">                    2             </td> <td style="width: 40%; text-align: center;">                 User Identification Number             </td> <td style="width: 30%; text-align: center;">                 1             </td> </tr> <tr> <td style="text-align: center;">                    L             </td> <td style="text-align: center;">                 L             </td> <td style="text-align: center;">                 L             </td> </tr> </table>                 | Operating range (Vdc):                               | 18V~54V | Normal Voltage (Vac): | 230V | MPPT Voltage Range (Vdc): | 24V~45V | Current (Max. continuous) (A): | 3A    | Max. DC input (Vdc): | 54V | Frequency (Hz): | 50Hz | Max. input continuous current (A): | 12Ax2 | Power Factor Range: | +/-0.95 | Max. input short-circuit current (A): | 15A | Maximum units per branch: | 8 | Ingress protection (IP): | IP67 | Protective class: | Class I | Power (Max. continuous) (W): | 660W  | Overvoltage category: OVC III (AC Main), OVC II (PV) |  | Temperature(°C): | -40°C to +65°C |  |  |    2       | User Identification Number | 1 |    L       | L | L |
| Operating range (Vdc):  | 18V~54V  | Normal Voltage (Vac):                                | 230V    |                       |      |                           |         |                                |       |                      |     |                 |      |                                    |       |                     |         |                                       |     |                           |   |                          |      |                   |         |                              |       |  |  |                  |                |  |  |   |                            |   |   |   |   |
| MPPT Voltage Range (Vdc):   | 24V~45V  | Current (Max. continuous) (A):                       | 3A      |                       |      |                           |         |                                |       |                      |     |                 |      |                                    |       |                     |         |                                       |     |                           |   |                          |      |                   |         |                              |       |  |  |                  |                |  |  |   |                            |   |   |   |   |
| Max. DC input (Vdc):  | 54V  | Frequency (Hz):                                      | 50Hz    |                       |      |                           |         |                                |       |                      |     |                 |      |                                    |       |                     |         |                                       |     |                           |   |                          |      |                   |         |                              |       |  |  |                  |                |  |  |   |                            |   |   |   |   |
| Max. input continuous current (A):  | 12Ax2  | Power Factor Range:                                  | +/-0.95 |                       |      |                           |         |                                |       |                      |     |                 |      |                                    |       |                     |         |                                       |     |                           |   |                          |      |                   |         |                              |       |  |  |                  |                |  |  |   |                            |   |   |   |   |
| Max. input short-circuit current (A):   | 15A  | Maximum units per branch:                            | 8       |                       |      |                           |         |                                |       |                      |     |                 |      |                                    |       |                     |         |                                       |     |                           |   |                          |      |                   |         |                              |       |  |  |                  |                |  |  |   |                            |   |   |   |   |
| Ingress protection (IP):  | IP67   | Protective class:                                    | Class I |                       |      |                           |         |                                |       |                      |     |                 |      |                                    |       |                     |         |                                       |     |                           |   |                          |      |                   |         |                              |       |  |  |                  |                |  |  |   |                            |   |   |   |   |
| Power (Max. continuous) (W):  | 660W   | Overvoltage category: OVC III (AC Main), OVC II (PV) |         |                       |      |                           |         |                                |       |                      |     |                 |      |                                    |       |                     |         |                                       |     |                           |   |                          |      |                   |         |                              |       |  |  |                  |                |  |  |   |                            |   |   |   |   |
| Temperature(°C):  | -40°C to +65°C   |  |         |                       |      |                           |         |                                |       |                      |     |                 |      |                                    |       |                     |         |                                       |     |                           |   |                          |      |                   |         |                              |       |  |  |                  |                |  |  |   |                            |   |   |   |   |
|    2       | User Identification Number   | 1  |         |                       |      |                           |         |                                |       |                      |     |                 |      |                                    |       |                     |         |                                       |     |                           |   |                          |      |                   |         |                              |       |  |  |                  |                |  |  |   |                            |   |   |   |   |
|    L       | L  | L  |         |                       |      |                           |         |                                |       |                      |     |                 |      |                                    |       |                     |         |                                       |     |                           |   |                          |      |                   |         |                              |       |  |  |                  |                |  |  |   |                            |   |   |   |   |
| <br><b>ENVERTECH</b><br>PV Microinverter<br>Model: EVT720<br>Zhejiang Envertech Corporation Ltd.<br>www.envertec.com   | <table style="width: 100%; border-collapse: collapse;"> <tr> <td style="width: 33%;">Operating range (Vdc):</td> <td style="width: 33%;">18V~54V</td> <td style="width: 33%;">Normal Voltage (Vac):</td> <td style="width: 33%;">230V</td> </tr> <tr> <td>MPPT Voltage Range (Vdc):</td> <td>24V~45V</td> <td>Current (Max. continuous) (A):</td> <td>3.27A</td> </tr> <tr> <td>Max. DC input (Vdc):</td> <td>54V</td> <td>Frequency (Hz):</td> <td>50Hz</td> </tr> <tr> <td>Max. input continuous current (A):</td> <td>12Ax2</td> <td>Power Factor Range:</td> <td>+/-0.95</td> </tr> <tr> <td>Max. input short-circuit current (A):</td> <td>15A</td> <td>Maximum units per branch:</td> <td>7</td> </tr> <tr> <td>Ingress protection (IP):</td> <td>IP67</td> <td>Protective class:</td> <td>Class I</td> </tr> <tr> <td>Power (Max. continuous) (W):</td> <td>720W</td> <td>Overvoltage category: OVC III (AC Main), OVC II (PV)</td> <td></td> </tr> <tr> <td>Temperature(°C):</td> <td colspan="3">-40°C to +65°C</td> </tr> </table><br><table style="width: 100%; border-collapse: collapse;"> <tr> <td style="width: 30%; text-align: center;">                    2             </td> <td style="width: 40%; text-align: center;">                 User Identification Number             </td> <td style="width: 30%; text-align: center;">                 1             </td> </tr> <tr> <td style="text-align: center;">                    L             </td> <td style="text-align: center;">                 L             </td> <td style="text-align: center;">                 L             </td> </tr> </table>     | Operating range (Vdc):                               | 18V~54V | Normal Voltage (Vac): | 230V | MPPT Voltage Range (Vdc): | 24V~45V | Current (Max. continuous) (A): | 3.27A | Max. DC input (Vdc): | 54V | Frequency (Hz): | 50Hz | Max. input continuous current (A): | 12Ax2 | Power Factor Range: | +/-0.95 | Max. input short-circuit current (A): | 15A | Maximum units per branch: | 7 | Ingress protection (IP): | IP67 | Protective class: | Class I | Power (Max. continuous) (W): | 720W  | Overvoltage category: OVC III (AC Main), OVC II (PV) |  | Temperature(°C): | -40°C to +65°C |  |  |    2    | User Identification Number | 1 |    L | L | L |
| Operating range (Vdc):  | 18V~54V  | Normal Voltage (Vac):                                | 230V    |                       |      |                           |         |                                |       |                      |     |                 |      |                                    |       |                     |         |                                       |     |                           |   |                          |      |                   |         |                              |       |  |  |                  |                |  |  |   |                            |   |   |   |   |
| MPPT Voltage Range (Vdc):   | 24V~45V  | Current (Max. continuous) (A):                       | 3.27A   |                       |      |                           |         |                                |       |                      |     |                 |      |                                    |       |                     |         |                                       |     |                           |   |                          |      |                   |         |                              |       |  |  |                  |                |  |  |   |                            |   |   |   |   |
| Max. DC input (Vdc):  | 54V  | Frequency (Hz):                                      | 50Hz    |                       |      |                           |         |                                |       |                      |     |                 |      |                                    |       |                     |         |                                       |     |                           |   |                          |      |                   |         |                              |       |  |  |                  |                |  |  |   |                            |   |   |   |   |
| Max. input continuous current (A):  | 12Ax2  | Power Factor Range:                                  | +/-0.95 |                       |      |                           |         |                                |       |                      |     |                 |      |                                    |       |                     |         |                                       |     |                           |   |                          |      |                   |         |                              |       |  |  |                  |                |  |  |   |                            |   |   |   |   |
| Max. input short-circuit current (A):   | 15A  | Maximum units per branch:                            | 7       |                       |      |                           |         |                                |       |                      |     |                 |      |                                    |       |                     |         |                                       |     |                           |   |                          |      |                   |         |                              |       |  |  |                  |                |  |  |   |                            |   |   |   |   |
| Ingress protection (IP):  | IP67   | Protective class:                                    | Class I |                       |      |                           |         |                                |       |                      |     |                 |      |                                    |       |                     |         |                                       |     |                           |   |                          |      |                   |         |                              |       |  |  |                  |                |  |  |   |                            |   |   |   |   |
| Power (Max. continuous) (W):  | 720W   | Overvoltage category: OVC III (AC Main), OVC II (PV) |         |                       |      |                           |         |                                |       |                      |     |                 |      |                                    |       |                     |         |                                       |     |                           |   |                          |      |                   |         |                              |       |  |  |                  |                |  |  |   |                            |   |   |   |   |
| Temperature(°C):  | -40°C to +65°C   |  |         |                       |      |                           |         |                                |       |                      |     |                 |      |                                    |       |                     |         |                                       |     |                           |   |                          |      |                   |         |                              |       |  |  |                  |                |  |  |   |                            |   |   |   |   |
|    2    | User Identification Number   | 1  |         |                       |      |                           |         |                                |       |                      |     |                 |      |                                    |       |                     |         |                                       |     |                           |   |                          |      |                   |         |                              |       |  |  |                  |                |  |  |   |                            |   |   |   |   |
|    L | L  | L  |         |                       |      |                           |         |                                |       |                      |     |                 |      |                                    |       |                     |         |                                       |     |                           |   |                          |      |                   |         |                              |       |  |  |                  |                |  |  |   |                            |   |   |   |   |
| <br><b>ENVERTECH</b><br>PV Microinverter<br>Model: EVT1200<br>Zhejiang Envertech Corporation Ltd.<br>www.envertec.com  | <table style="width: 100%; border-collapse: collapse;"> <tr> <td style="width: 33%;">Operating range (Vdc):</td> <td style="width: 33%;">18V~54V</td> <td style="width: 33%;">Normal Voltage (Vac):</td> <td style="width: 33%;">230V</td> </tr> <tr> <td>MPPT Voltage Range (Vdc):</td> <td>24V~45V</td> <td>Current (Max. continuous) (A):</td> <td>5.45A</td> </tr> <tr> <td>Max. DC input (Vdc):</td> <td>54V</td> <td>Frequency (Hz):</td> <td>50Hz</td> </tr> <tr> <td>Max. input continuous current (A):</td> <td>12Ax4</td> <td>Power Factor Range:</td> <td>+/-0.95</td> </tr> <tr> <td>Max. input short-circuit current (A):</td> <td>15A</td> <td>Maximum units per branch:</td> <td>5</td> </tr> <tr> <td>Ingress protection (IP):</td> <td>IP67</td> <td>Protective class:</td> <td>Class I</td> </tr> <tr> <td>Power (Max. continuous) (W):</td> <td>1200W</td> <td>Overvoltage category: OVC III (AC Main), OVC II (PV)</td> <td></td> </tr> <tr> <td>Temperature(°C):</td> <td colspan="3">-40°C to +65°C</td> </tr> </table><br><table style="width: 100%; border-collapse: collapse;"> <tr> <td style="width: 30%; text-align: center;">                    3             </td> <td style="width: 40%; text-align: center;">                 User Identification Number             </td> <td style="width: 30%; text-align: center;">                 1             </td> </tr> <tr> <td style="text-align: center;">                    4             </td> <td style="text-align: center;">                 L             </td> <td style="text-align: center;">                 2             </td> </tr> </table> | Operating range (Vdc):                               | 18V~54V | Normal Voltage (Vac): | 230V | MPPT Voltage Range (Vdc): | 24V~45V | Current (Max. continuous) (A): | 5.45A | Max. DC input (Vdc): | 54V | Frequency (Hz): | 50Hz | Max. input continuous current (A): | 12Ax4 | Power Factor Range: | +/-0.95 | Max. input short-circuit current (A): | 15A | Maximum units per branch: | 5 | Ingress protection (IP): | IP67 | Protective class: | Class I | Power (Max. continuous) (W): | 1200W | Overvoltage category: OVC III (AC Main), OVC II (PV) |  | Temperature(°C): | -40°C to +65°C |  |  |    3 | User Identification Number | 1 |    4 | L | 2 |
| Operating range (Vdc):  | 18V~54V  | Normal Voltage (Vac):                                | 230V    |                       |      |                           |         |                                |       |                      |     |                 |      |                                    |       |                     |         |                                       |     |                           |   |                          |      |                   |         |                              |       |  |  |                  |                |  |  |   |                            |   |   |   |   |
| MPPT Voltage Range (Vdc):   | 24V~45V  | Current (Max. continuous) (A):                       | 5.45A   |                       |      |                           |         |                                |       |                      |     |                 |      |                                    |       |                     |         |                                       |     |                           |   |                          |      |                   |         |                              |       |  |  |                  |                |  |  |   |                            |   |   |   |   |
| Max. DC input (Vdc):  | 54V  | Frequency (Hz):                                      | 50Hz    |                       |      |                           |         |                                |       |                      |     |                 |      |                                    |       |                     |         |                                       |     |                           |   |                          |      |                   |         |                              |       |  |  |                  |                |  |  |   |                            |   |   |   |   |
| Max. input continuous current (A):  | 12Ax4  | Power Factor Range:                                  | +/-0.95 |                       |      |                           |         |                                |       |                      |     |                 |      |                                    |       |                     |         |                                       |     |                           |   |                          |      |                   |         |                              |       |  |  |                  |                |  |  |   |                            |   |   |   |   |
| Max. input short-circuit current (A):   | 15A  | Maximum units per branch:                            | 5       |                       |      |                           |         |                                |       |                      |     |                 |      |                                    |       |                     |         |                                       |     |                           |   |                          |      |                   |         |                              |       |  |  |                  |                |  |  |   |                            |   |   |   |   |
| Ingress protection (IP):  | IP67   | Protective class:                                    | Class I |                       |      |                           |         |                                |       |                      |     |                 |      |                                    |       |                     |         |                                       |     |                           |   |                          |      |                   |         |                              |       |  |  |                  |                |  |  |   |                            |   |   |   |   |
| Power (Max. continuous) (W):  | 1200W  | Overvoltage category: OVC III (AC Main), OVC II (PV) |         |                       |      |                           |         |                                |       |                      |     |                 |      |                                    |       |                     |         |                                       |     |                           |   |                          |      |                   |         |                              |       |  |  |                  |                |  |  |   |                            |   |   |   |   |
| Temperature(°C):  | -40°C to +65°C   |  |         |                       |      |                           |         |                                |       |                      |     |                 |      |                                    |       |                     |         |                                       |     |                           |   |                          |      |                   |         |                              |       |  |  |                  |                |  |  |   |                            |   |   |   |   |
|    3 | User Identification Number   | 1  |         |                       |      |                           |         |                                |       |                      |     |                 |      |                                    |       |                     |         |                                       |     |                           |   |                          |      |                   |         |                              |       |  |  |                  |                |  |  |   |                            |   |   |   |   |
|    4 | L  | 2  |         |                       |      |                           |         |                                |       |                      |     |                 |      |                                    |       |                     |         |                                       |     |                           |   |                          |      |                   |         |                              |       |  |  |                  |                |  |  |   |                            |   |   |   |   |

**Possible test case verdicts:**

- test case does not apply to the test object .....: N/A
- test object was not evaluated for the requirement.....: N/E
- test object does meet the requirement.....: Pass (P)
- test object does not meet the requirement.....: Fail (F)

**Testing:**

Date of receipt of test items .....: 04.11.2019

Date(s) of performance of tests .....: 04.11.2019 – 15.01.2020

**General remarks:**

"(see Attachment #)" refers to additional information appended to the report.

"(see appended table)" refers to a table appended to the report.

The tests results presented in this report relate only to the object tested.

This report shall not be reproduced except in full without the written approval of the testing laboratory.

List of test equipment must be kept on file and available for review.

Additional test data and/or information provided in the attachments to this report.

Throughout this report a  comma /  point is used as the decimal separator.

Generator reference system:

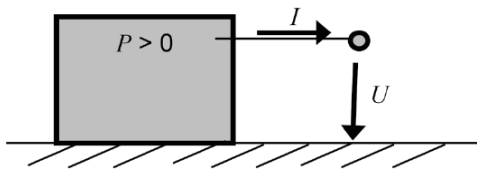

**General product information:**
Brief description:

The PCEs under test are single-phase grid connected micro inverter for solar power generation. The Grid-connected Inverter utilize the advanced power conversion technology IGBT to convert the DC power normally from the photovoltaic array to stable three-phase AC power and then feed the power to the utility grid. The interface protection device is comprised by a group of power relays and bridge MOSFETs since each dc input string is separated from grid by high frequency transformer.

The controlling section is also redundant built, one master CPU, and one slave CPU. In case any one of two chips breaks down or runs a wrong program, which result to the loss of protection function, the another chip could indicate the fault and disconnect the equipment immediately.

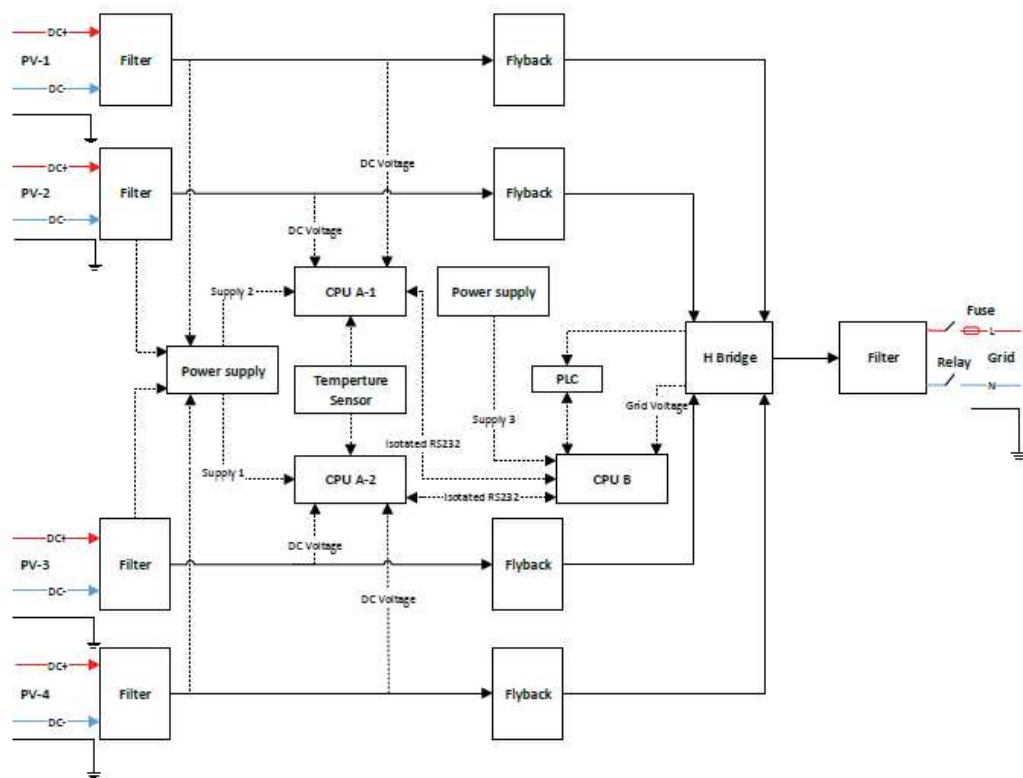

Block Diagram of EVT1200

Model Difference:

All series models have the same electrical character, control method and software.

Unless otherwise specified, all tests were performed on the model EVT600 to represent other family models.

Remote control:

The remote control of product is realized by power line communication technology.

The product was tested on:

Software version: v1.04

Test condition:

Temperature: 25°C

Relative humidity: 70%



**Model list:**

| MODELS LIST                           |  | EVT300   | EVT360 | EVT560 | EVT600 | EVT660 | EVT720 | EVT1200 |
|---------------------------------------|--|--|--------|--------|--------|--------|--------|---------|
| PV INPUT                              | $V_{MAX}$ PV [Vdc]   | 54   |        |        |        |        |        |         |
|                                       | $I_{SC}$ PV [A]  | 15   | 15     | 15*2   | 15*2   | 15*2   | 15*2   | 15*4    |
|                                       | MPP Voltage Range $V_{MPP}$ [Vdc]  | 24 - 45  |        |        |        |        |        |         |
|                                       | Max. Input Current $I_{MAX}$ [A]   | 12   | 12     | 12*2   | 12*2   | 12*2   | 12*2   | 12*4    |
| BAT INPUT                             | Rated input voltage [V]  | N/A  |        |        |        |        |        |         |
|                                       | Input voltage range [V]  | N/A  |        |        |        |        |        |         |
|                                       | Max. current [A]   | N/A  |        |        |        |        |        |         |
|                                       | Battery Type   | N/A  |        |        |        |        |        |         |
| AC OUTPUT                             | Rated Output Voltage $U_r$ [Vac]   | 230  |        |        |        |        |        |         |
|                                       | Normal Operating Voltage Range $U_n$ [Vac]                                 | 195.5 - 264.5 (VDE-AR-N 4105)  |        |        |        |        |        |         |
|                                       | Rated Output Frequency $F_{NETZ}$ [Hz]                                     | 50.0   |        |        |        |        |        |         |
|                                       | Normal Operating Voltage Range $F_n$ [Hz]                                  | 47.5-51.5 (VDE-AR-N 4105)  |        |        |        |        |        |         |
|                                       | Rated Active Power $P_E$ [W]   | 300  | 360    | 560    | 600    | 660    | 720    | 1200    |
|                                       | Max. Active Power $P_{E_{max}}$ [W]  | 300  | 360    | 560    | 600    | 660    | 720    | 1200    |
|                                       | Max. Apparent power $S_{E_{max}}$ [VA]                                     | 300  | 360    | 560    | 600    | 660    | 720    | 1200    |
|                                       | Max. Output Current $I_{max}$ [A]  | 1.36   | 1.63   | 2.54   | 2.72   | 3.00   | 3.27   | 5.45    |
| Power Factor $\cos\phi$ [ $\lambda$ ] | [0.95 <sub>under-excited</sub> , 0.95 <sub>over-excited</sub> ] adjustable |  |        |        |        |        |        |         |
| ROTECTION SETTINGS                    | Firmware version   | v1.04  |        |        |        |        |        |         |
|                                       | Voltage threshold value [V]  | $U_{MIN}$ stage 1: 184.0, $U_{MIN}$ stage 2: 103.5<br>$U_{MAX}$ stage 1: 253.0, $U_{MAX}$ stage 2: 287.5   |        |        |        |        |        |         |
|                                       | The accuracy of voltage measurement [%/V]                                  | Min (2.3Vrms, 1%)  |        |        |        |        |        |         |
|                                       | Voltage trip time [ms]   | $U_{MIN}$ stage 1: <3100 ( $T_{LIMIT}$ : <3100)<br>$U_{MIN}$ stage 2: <400 ( $T_{LIMIT}$ : <400)<br>$U_{MAX}$ stage 1: <200 ( $T_{LIMIT}$ : <200)<br>$U_{MAX}$ stage 2: <200 ( $T_{LIMIT}$ : <200) |        |        |        |        |        |         |
|                                       | Frequency threshold value [Hz]   | $F_{MIN}$ : 47.5, $F_{MAX}$ : 51.5   |        |        |        |        |        |         |
|                                       | The accuracy of frequency measurement [%/Hz]                               | Min (0.01Hz, 0.1%)   |        |        |        |        |        |         |
|                                       | Frequency trip time [ms]   | $F_{MIN}$ : <200 ( $T_{LIMIT}$ : 200), $F_{MAX}$ : <200 ( $T_{LIMIT}$ : 200)   |        |        |        |        |        |         |
|                                       | Active anti-islanding trip time [s]  | <9.0 ( $T_{LIMIT}$ : 9)  |        |        |        |        |        |         |
|                                       | Reconnection Voltage [V]   | $U_{MIN}$ : 195.5, $U_{MAX}$ : 253.0   |        |        |        |        |        |         |
|                                       | Reconnection Frequency [Hz]  | $F_{MIN}$ : 47.5 ( $F_{LIMIT}$ : 47.5), $F_{MAX}$ : 50.10 ( $F_{LIMIT}$ : 50.10)   |        |        |        |        |        |         |
| Reconnection Time [s]                 | 60 ( $T_{LIMIT} \geq 60$ )   |  |        |        |        |        |        |         |

**Throughout the test report following abbreviations may be used:**

|             |                  |  |
|-------------|------------------|--|
| General     | $P_{E_{max}}$    | Highest measured active power of generator, as 10min average value, equal to $P_{E_{max600}}$ . Determination of $P_{E_{max600}}$ see table 5.7.2.2 for detail.    |
| General     | $S_{E_{max}}$    | Highest measured apparant power of generator, as 10 min average value, equal to $S_{E_{max600}}$ . Determination of $S_{E_{max600}}$ see table 5.7.2.2 for detail. |
| General     | EUT              | Equipment under test   |
| General     | PGU              | Power generator unit   |
| General     | PGS              | Power generator system   |
| General     | ESS              | Energy storage system  |
| Table 5.4.2 | $P_{E_{max}^*)}$ | Possible maximum active power as 10min average value under the corresponded test condition. *) might represent a) to c).   |
| Table 5.4.2 | $S_{E_{max}^*)}$ | Possible maximum active power as 10min average value under the corresponded test condition. *) might represent a) to c).   |
| Table 5.4.2 | $P_{E_{max600}}$ | $P_{E_{max600}} = \max(P_{E_{max600a}}, P_{E_{max600b}}, P_{E_{max600c}})$   |
| Table 5.4.2 | $S_{E_{max600}}$ | $S_{E_{max600}} = \max(S_{E_{max600a}}, S_{E_{max600b}}, S_{E_{max600c}})$   |
| Table 5.5.4 | o-c              | Open-circuited   |
| Table 5.5.4 | s-c              | Short-circuited  |
| Table 5.5.4 | SD               | Shut down  |
| Table 5.5.4 | RO               | Recovered to Operate after removing the single fault   |
| Table 5.5.4 | DG               | Disconnection to grid  |
| Table 5.5.4 | NCD              | No components damaged  |
| Table 5.5.4 | NH               | No Hazards   |
| Table 5.5.4 | FID              | Fault indication   |

| Summary of tests:                              |   |
|--|---|
| Clause   | Test items  |
| <input checked="" type="checkbox"/> <b>5.2</b> | <b>Verification of network reaction</b>                                       |
| <input checked="" type="checkbox"/> 5.2.2      | Rapid voltage change  |
| <input checked="" type="checkbox"/> 5.2.3      | Flicker   |
| <input checked="" type="checkbox"/> 5.2.4      | Harmonics and Inter-harmonics   |
| <input checked="" type="checkbox"/> 5.2.5      | Commutation notches   |
| <input checked="" type="checkbox"/> 5.2.6      | DC current feeding to network   |
| <input type="checkbox"/> <b>5.3</b>            | <b>Verification of symmetry character of inverter</b>                         |
| <input type="checkbox"/> 5.3.2.1               | Calculation of asymmetry of three-phase inverter                              |
| <input type="checkbox"/> 5.3.2.2.1             | Loss of individual inverter   |
| <input type="checkbox"/> 5.3.2.2.2             | Power reduction of individual inverter  |
| <input type="checkbox"/> 5.3.2.3               | Symmetry operation with a symmetry device                                     |
| <input checked="" type="checkbox"/> <b>5.4</b> | <b>Verification of character of PGU in network</b>                            |
| <input checked="" type="checkbox"/> 5.4.2      | Measurement of active- and reactive power range                               |
| <input checked="" type="checkbox"/> 5.4.3      | Active power reduction through setting command                                |
| <input checked="" type="checkbox"/> 5.4.3.2    | Measure of accuracy   |
| <input checked="" type="checkbox"/> 5.4.3.3    | Measure of power gradient   |
| <input type="checkbox"/> 5.4.3.4               | Measure of interface priority   |
| <input checked="" type="checkbox"/> 5.4.4      | Active power of PGU by over frequency   |
| <input type="checkbox"/> 5.4.5                 | Active power of ESS by over frequency   |
| <input checked="" type="checkbox"/> 5.4.6      | Active power of PGU by under frequency  |
| <input type="checkbox"/> 5.4.7                 | Active power of ESS by under frequency  |
| <input checked="" type="checkbox"/> 5.4.8      | Static voltage maintenance / reactive power provision                         |
| <input checked="" type="checkbox"/> 5.4.8.1    | Tests of reactive power / displacement factor accuracy                        |
| <input checked="" type="checkbox"/> 5.4.8.2    | Tests of displacement factor- / active power character line $\cos\varphi$ (P) |
| <input type="checkbox"/> 5.4.8.3               | Tests of reactive power-voltage character line Q(U)                           |
| <input type="checkbox"/> 5.4.8.3.1             | Tests of accuracy of Q(U) control   |
| <input type="checkbox"/> 5.4.8.3.2             | Tests of dynamic of Q(U) control  |
| <input checked="" type="checkbox"/> <b>5.5</b> | <b>Verification of NS protection</b>  |
| <input type="checkbox"/> 5.5.3                 | Central NS protection   |
| <input checked="" type="checkbox"/> 5.5.4      | Integrated NS protection  |
| <input type="checkbox"/> 5.5.6.2               | Central interface switch  |
| <input checked="" type="checkbox"/> 5.5.6.3    | Integrated interface switch   |
| <input checked="" type="checkbox"/> 5.5.7      | Protection devices and settings   |
| <input checked="" type="checkbox"/> 5.5.8      | Indication of NS protection   |
| <input checked="" type="checkbox"/> 5.5.9      | Constructional features of NS protection                                      |

|  |   |
|--|---|
| <input checked="" type="checkbox"/> 5.5.10     | Islanding detection                                     |
| <input checked="" type="checkbox"/> <b>5.6</b> | <b>Connection conditions and synchronization</b>        |
| <input checked="" type="checkbox"/> <b>5.7</b> | <b>Verification of <math>P_{AV,E}</math> monitoring</b> |
| <input checked="" type="checkbox"/> <b>5.8</b> | <b>Verification of dynamic network supporting</b>       |

|   |                             |             |             |      |
|---|-----------------------------|-------------|-------------|------|
| 5.2.2   | TABLE: Rapid voltage change |             |             | P    |
| Test voltage: 230V, 50Hz  |                             |             |             |      |
| Equipment used: PVE-029, PVE-036, PVE-037, PVE-038, PVE-076, PVE-002, PVE-001, PVE-080, PVE-081, PVE-082, PVE-083 |                             |             |             |      |
| Switching actions   |                             | U r.m.s [V] | I r.m.s [A] | Ki   |
| Marking operation without default (to primary energy carrier)   |                             | 230.6       | 1.30        | 0.50 |
| Worst case at switch over of generator sections   |                             | N/A         | N/A         | N/A  |
| Marking operation at reference conditions(of primary energy carrier)  |                             | 231         | 2.60        | 1.00 |
| Breaking operation at nominal power   |                             | 231         | 2.60        | 1.00 |
| Worst case value of all switching operations Ki max   |                             | 1.00        |             |      |

| 5.2.3  | TABLE: Flicker |  |                     | P |
|--|----------------|--|---------------------|---|
| <input checked="" type="checkbox"/> PGU and ESS with nominal current $\leq 75A$ (Per DIN EN 61000-3-3 / DIN EN 61000-3-11) |                |  |                     |   |
| Test voltage: 230V, 50Hz   |                |  |                     |   |
| Equipment used: PVE-029, PVE-036, PVE-037, PVE-038, PVE-076, PVE-002, PVE-001, PVE-080, PVE-081, PVE-082, PVE-083, PVE-017 |                |  |                     |   |
| <input checked="" type="checkbox"/> Zref : $Z_A = 0.24+0.15j$ , $Z_N = 0.16+0.10j$   |                | <input type="checkbox"/> Ztest : $Z_A = 0.15+0.15j$ , $Z_N = 0.10+0.10j$ |                     |   |
| Test No.   | Power [%]      | Pst  | C <sub>yk</sub>     |   |
| 1  | 100            | 0.25   | 8.33                |   |
| 2  | 100            | 0.23   | 7.66                |   |
| 3  | 100            | 0.29   | 9.66                |   |
| 4  | 100            | 0.26   | 8.66                |   |
| 5  | 100            | 0.25   | 8.33                |   |
| 6  | 100            | 0.25   | 8.33                |   |
| 7  | 100            | 0.27   | 8.99                |   |
| 8  | 100            | 0.26   | 8.66                |   |
| 9  | 100            | 0.28   | 9.32                |   |
| 10   | 100            | 0.26   | 8.66                |   |
| 11   | 100            | 0.25   | 8.33                |   |
| 12   | 100            | 0.25   | 8.33                |   |
| Plt  |                | 0.26   | C <sub>yk</sub> max |   |
|  |                |  | 9.66                |   |
| Remark:<br>Pst=Pst test * Zref / Ztest, Plt=Plt test * Zref / Ztest  |                |  |                     |   |

| 5.2.4                         |                     | TABLE: Harmonics and inter-harmonics |                    |                    | P |
|-------------------------------|---------------------|--------------------------------------|--------------------|--------------------|---|
| Test voltage: 230V, 50Hz      |                     |                                      |                    |                    |   |
| Harmonics (Per IEC 61000-3-2) |                     |                                      |                    |                    |   |
| Rated power condition         | I <sub>h_mean</sub> | Class A Limit                        | I <sub>h_max</sub> | 150% Class A Limit |   |
| Harmonic number               | [A]                 | [A]                                  | [A]                | [A]                |   |
| 2                             | 0.009               | 1.08                                 | 0.011              | 1.62               |   |
| 3                             | 0.039               | 2.3                                  | 0.045              | 3.45               |   |
| 4                             | 0.006               | 0.43                                 | 0.008              | 0.65               |   |
| 5                             | 0.047               | 1.14                                 | 0.053              | 1.71               |   |
| 6                             | 0.003               | 0.30                                 | 0.005              | 0.45               |   |
| 7                             | 0.012               | 0.77                                 | 0.016              | 1.16               |   |
| 8                             | 0.003               | 0.23                                 | 0.005              | 0.35               |   |
| 9                             | 0.003               | 0.40                                 | 0.004              | 0.60               |   |
| 10                            | 0.002               | 0.18                                 | 0.004              | 0.27               |   |
| 11                            | 0.003               | 0.33                                 | 0.005              | 0.50               |   |
| 12                            | 0.001               | 0.15                                 | 0.003              | 0.23               |   |
| 13                            | 0.001               | 0.21                                 | 0.001              | 0.32               |   |
| 14                            | 0.001               | 0.13                                 | 0.001              | 0.20               |   |
| 15                            | 0.002               | 0.15                                 | 0.002              | 0.23               |   |
| 16                            | 0.000               | 0.12                                 | 0.001              | 0.18               |   |
| 17                            | 0.002               | 0.13                                 | 0.003              | 0.20               |   |
| 18                            | 0.001               | 0.10                                 | 0.002              | 0.15               |   |
| 19                            | 0.000               | 0.12                                 | 0.002              | 0.18               |   |
| 20                            | 0.000               | 0.09                                 | 0.001              | 0.14               |   |
| 21                            | 0.001               | 0.11                                 | 0.001              | 0.17               |   |
| 22                            | 0.000               | 0.08                                 | 0.001              | 0.12               |   |
| 23                            | 0.001               | 0.10                                 | 0.002              | 0.15               |   |
| 24                            | 0.000               | 0.08                                 | 0.002              | 0.12               |   |
| 25                            | 0.002               | 0.09                                 | 0.003              | 0.14               |   |
| 26                            | 0.000               | 0.07                                 | 0.001              | 0.11               |   |
| 27                            | 0.002               | 0.08                                 | 0.003              | 0.12               |   |
| 28                            | 0.000               | 0.07                                 | 0.002              | 0.11               |   |
| 29                            | 0.003               | 0.08                                 | 0.003              | 0.12               |   |
| 30                            | 0.000               | 0.06                                 | 0.001              | 0.09               |   |
| 31                            | 0.002               | 0.07                                 | 0.002              | 0.11               |   |
| 32                            | 0.000               | 0.06                                 | 0.001              | 0.09               |   |
| 33                            | 0.002               | 0.07                                 | 0.003              | 0.11               |   |
| 34                            | 0.000               | 0.05                                 | 0.000              | 0.08               |   |
| 35                            | 0.001               | 0.06                                 | 0.001              | 0.09               |   |
| 36                            | 0.000               | 0.05                                 | 0.001              | 0.08               |   |
| 37                            | 0.001               | 0.06                                 | 0.002              | 0.09               |   |
| 38                            | 0.000               | 0.05                                 | 0.001              | 0.08               |   |
| 39                            | 0.000               | 0.06                                 | 0.001              | 0.09               |   |
| 40                            | 0.000               | 0.05                                 | 0.001              | 0.08               |   |

| 5.2.5   | TABLE: Commutation notches | P                               |   |   |
|---|----------------------------|---------------------------------|---|---|
| Equipment used: PVE-029, PVE-036, PVE-037, PVE-038, PVE-076, PVE-002, PVE-001, PVE-080, PVE-081, PVE-082, PVE-083 |                            |                                 |   |   |
| Test condition  |                            | Commutation notches current [A] |   |   |
| Between 25% P <sub>E<sub>max</sub></sub> and 35% P <sub>E<sub>max</sub></sub>                                     |                            | 0                               | 0 | 0 |
| Between 65% P <sub>E<sub>max</sub></sub> and 75% P <sub>E<sub>max</sub></sub>                                     |                            | 0                               | 0 | 0 |
| > 90 P <sub>E<sub>max</sub></sub>   |                            | 0                               | 0 | 0 |
| Remark: No Commutation notches currents were observed in test.  |                            |                                 |   |   |

| 5.2.6   | TABLE: DC current feeding | P       |            |
|---|---------------------------|---------|------------|
| Test voltage: 230V, 50Hz  |                           |         |            |
| Equipment used: PVE-029, PVE-036, PVE-037, PVE-038, PVE-076, PVE-002, PVE-001, PVE-080, PVE-081, PVE-082, PVE-083 |                           |         |            |
| S/S <sub>E<sub>max</sub></sub>  | 30% - 40%                 |         |            |
| Measurement [mA]  |                           |         | Limitation |
| Phase A   | Phase B                   | Phase C |            |
| 17.1  | N/A                       | N/A     | 20mA       |
| S/S <sub>E<sub>max</sub></sub>  | 60% - 70%                 |         |            |
| Measurement [mA]  |                           |         | Limitation |
| Phase A   | Phase B                   | Phase C |            |
| 18.8  | N/A                       | N/A     | 20mA       |
| S/S <sub>E<sub>max</sub></sub>  | > 95%                     |         |            |
| Measurement [mA]  |                           |         | Limitation |
| Phase A   | Phase B                   | Phase C |            |
| 16.0  | N/A                       | N/A     | 20mA       |
| Remark: The max. absolute value of measurements shall be taken.   |                           |         |            |

| 5.4.2   |                           | TABLE: Measurement of active- and reactive power ranges |             |       |                               |                                |         |                     | P                         |  |
|---|---------------------------|---|-------------|-------|-------------------------------|--------------------------------|---------|---------------------|---------------------------|--|
| Equipment used: PVE-029, PVE-036, PVE-037, PVE-038, PVE-076, PVE-002, PVE-001, PVE-080, PVE-081, PVE-082, PVE-083 |                           |   |             |       |                               |                                |         |                     |                           |  |
| No.   | Test condition            |   | Measurement |       |                               |                                |         |                     |                           |  |
|   | $\text{Cos}\varphi$       | U / Un  | U [V]       | I [A] | $P_{E_{\text{max}600^*}}$ [W] | $S_{E_{\text{max}600^*}}$ [VA] | Q [Var] | $\text{Cos}\varphi$ | Limit $\text{Cos}\varphi$ |  |
| a1  | 1.00                      | 90%   | 207.7       | 2.9   | 607.3                         | 607.6                          | 19.6    | 1.000               | --                        |  |
| a2  |                           | 95%   | 219.2       | 2.8   | 607.0                         | 607.3                          | 19.1    | 1.000               | --                        |  |
| a3  |                           | 100%  | 230.6       | 2.6   | 610.8                         | 611.0                          | 15.5    | 1.000               | --                        |  |
| a4  |                           | 105%  | 242.0       | 2.5   | 608.5                         | 609.1                          | 26.7    | 0.999               | --                        |  |
| a5  |                           | 109%  | 251.2       | 2.4   | 608.6                         | 608.7                          | 14.7    | 1.000               | --                        |  |
| b1  | max.<br>under-<br>excited | 90%   | 208.2       | 3.0   | 581.5                         | 622.3                          | 221.5   | 0.935               | --                        |  |
| b2  |                           | 95%   | 219.6       | 2.9   | 594.0                         | 623.0                          | 187.7   | 0.954               | $\leq 0.95$               |  |
| b3  |                           | 100%  | 231.0       | 2.7   | 590.8                         | 621.3                          | 192.4   | 0.951               | $\leq 0.95$               |  |
| b4  |                           | 105%  | 242.4       | 2.6   | 587.0                         | 619.1                          | 196.8   | 0.948               | $\leq 0.95$               |  |
| B5  |                           | 109%  | 251.6       | 2.5   | 583.0                         | 621.2                          | 214.5   | 0.939               | $\leq 0.95$               |  |
| c1  | max.<br>over-<br>excited  | 90%   | 207.9       | 3.2   | 587.9                         | 627.3                          | -219.0  | 0.937               | $\leq 0.95$               |  |
| c2  |                           | 95%   | 219.4       | 2.9   | 588.1                         | 616.6                          | -185.2  | 0.954               | $\leq 0.95$               |  |
| c3  |                           | 100%  | 230.9       | 2.7   | 585.0                         | 613.7                          | -185.4  | 0.953               | $\leq 0.95$               |  |
| c4  |                           | 105%  | 242.3       | 2.5   | 574.7                         | 602.7                          | -181.8  | 0.953               | $\leq 0.95$               |  |
| C5  |                           | 109%  | 251.6       | 2.5   | 571.0                         | 603.5                          | -195.4  | 0.946               | $\leq 0.95$               |  |
| $P_{E_{\text{max}600}}$ [W]   |                           |   | 610.8       |       |                               |                                |         |                     |                           |  |
| $S_{E_{\text{max}600}}$ [VA]  |                           |   | 627.3       |       |                               |                                |         |                     |                           |  |
| Remark:.  |                           |   |             |       |                               |                                |         |                     |                           |  |



|   |  |       |       |        |                                 |        |        |        |        |   |   |
|---|--|-------|-------|--------|---------------------------------|--------|--------|--------|--------|---|---|
| 5.4.3   | TABLE: Active power reduction by setting command |       |       |        |                                 |        |        |        |        |   | P |
| Test voltage: 230V, 50Hz  |  |       |       |        |                                 |        |        |        |        |   |   |
| Equipment used: PVE-029, PVE-036, PVE-037, PVE-038, PVE-076, PVE-002, PVE-001, PVE-080, PVE-081, PVE-082, PVE-083 |  |       |       |        |                                 |        |        |        |        |   |   |
| Nominal active power $P_n$ [W]  |  |       |       |        | 600                             |        |        |        |        |   |   |
| Setting P/ $P_n$  | 100%   | 90%   | 80%   | 70%    | 60%                             | 50%    | 40%    | 30%    | 20%    | 10%   |   |
| P [W]   | 599.9  | 541.4 | 482.8 | 420.0  | 359.6                           | 299.2  | 239.1  | 179.6  | 119.4  | 58.67   |   |
| $\Delta P / P_n$  | -0.02%   | 0.21% | 0.46% | -0.01% | -0.06%                          | -0.14% | -0.15% | -0.07% | -0.11% | -0.22%  |   |
| Limitation $\Delta P / P_n$   | ± 5%   |       |       |        |                                 |        |        |        |        |   |   |
| PGU disconnect from network ?   |  |       |       |        |                                 |        |        |        |        | <input type="checkbox"/> Yes <input checked="" type="checkbox"/> No |   |
| Power gradient (100% $P_n$ → 5% $P_n$ ):  |  |       |       |        | 0.50% $P_n$ /s                  |        |        |        |        |   |   |
| Power gradient (5% $P_n$ → 100% $P_n$ ):  |  |       |       |        | 0.50% $P_n$ /s                  |        |        |        |        |   |   |
| Limitation of gradient [W/s]  |  |       |       |        | 0.33% $P_n$ /s – 0.66% $P_n$ /s |        |        |        |        |   |   |
| Multiple security management interface provided by PGU ?  |  |       |       |        |                                 |        |        |        |        | <input type="checkbox"/> Yes <input checked="" type="checkbox"/> No |   |

| 5.4.4   |                | TABLE: Active power feeding of PGU at over frequency   |                  |   |  |                                     |                                    |                       | P |
|---|----------------|--|------------------|---|--|-------------------------------------|------------------------------------|-----------------------|---|
| Equipment used: PVE-029, PVE-036, PVE-037, PVE-038, PVE-076, PVE-002, PVE-001, PVE-080, PVE-081, PVE-082, PVE-083 |                |  |                  |   |  |                                     |                                    |                       |   |
| Test No. 1:   |                |  |                  |   |  |                                     |                                    |                       |   |
| Power output:   |                | 100% P <sub>E<sub>max</sub></sub>  |                  |   |  |                                     |                                    |                       |   |
| Starting frequency:   |                | 50.2Hz   |                  |   |  |                                     |                                    |                       |   |
| Droop:  |                | 5% (40%Pref / Hz)  |                  |   |  |                                     |                                    |                       |   |
| No.   | Frequency [Hz] | DC available power [W]   | Power output [W] | Target power [P/ P <sub>E<sub>max</sub></sub> ] | Deviation ΔP/ P <sub>E<sub>max</sub></sub> | Rise time T <sub>rise_90%</sub> [s] | Settling time T <sub>set</sub> [s] | Response delay Tv [s] |   |
| Limitation  |                | --   | --               | --  | < ± 10%                                    | < 2                                 | < 20                               | < 2                   |   |
| a)  | 50.00          | 630  | 579              | 100%  | -3.44%                                     | --                                  | --                                 | --                    |   |
| b)  | 50.25          | 630  | 569              | 98%   | -3.16%                                     | 0.6                                 | 0.6                                | 0.5                   |   |
| c)  | 50.70          | 630  | 463              | 80%   | -2.88%                                     | 0.85                                | 0.85                               | 0.0                   |   |
| d)  | 51.40          | 630  | 300              | 52%   | -2.07%                                     | 1.2                                 | 1.2                                | 0.0                   |   |
| e)  | 50.70          | 630  | 459              | 80%   | -3.53%                                     | 1.2                                 | 1.2                                | 0.0                   |   |
| f)  | 50.25          | 630  | 564              | 98%   | -3.94%                                     | 0.7                                 | 0.7                                | 0.0                   |   |
| g)  | 50.00          | 630  | 570              | 100%  | -4.94%                                     | 0.5                                 | 0.5                                | 0.0                   |   |
| h)  | 51.65          | Disconnection Time[ms]: <u>52.0</u> , Limitation[ms]: <u>200</u>   |                  |   |  |                                     |                                    |                       |   |
| i)  | 50.15          | Reconnection : <input type="checkbox"/> Yes/ <input checked="" type="checkbox"/> No, Limitation: No reconnection is allowed. |                  |   |  |                                     |                                    |                       |   |
| j)  | 50.00          | Maximal Rising Gradient [W/min]: <u>49.0</u> , Limitation [W/min]: <u>60</u>   |                  |   |  |                                     |                                    |                       |   |
| Test No. 2:   |                |  |                  |   |  |                                     |                                    |                       |   |
| Power output:   |                | 60% P <sub>E<sub>max</sub></sub>   |                  |   |  |                                     |                                    |                       |   |
| Starting frequency:   |                | 50.5Hz   |                  |   |  |                                     |                                    |                       |   |
| Droop:  |                | 12% (16.67%Pref / Hz)  |                  |   |  |                                     |                                    |                       |   |
| No.   | Frequency [Hz] | DC available power [W]   | Power output [W] | Target power [P/ P <sub>E<sub>max</sub></sub> ] | Deviation ΔP/ P <sub>E<sub>max</sub></sub> | Rise time T <sub>rise_90%</sub> [s] | Settling time T <sub>set</sub> [s] | Response delay Tv [s] |   |
| Limitation  |                | --   | --               | --  | < ± 10%                                    | < 2                                 | < 20                               | < 2                   |   |
| a)  | 50.00          | 380  | 355              | 60%   | -0.90%                                     | --                                  | --                                 | --                    |   |
| b)  | 50.40          | 380  | 354              | 60%   | -1.03%                                     | --                                  | --                                 | --                    |   |
| c)  | 50.70          | 380  | 345              | 58%   | -0.53%                                     | 0.7                                 | 0.7                                | 0.0                   |   |
| Set the primary available power or release the power limit to 100%P <sub>E<sub>max</sub></sub>                    |                |  |                  |   |  |                                     |                                    |                       |   |
| d)  | 51.40          | 630  | 298              | 51%   | -1.32%                                     | 0.75                                | 0.75                               | 0.0                   |   |
| e)  | 50.70          | 630  | 341              | 58%   | -1.23%                                     | 0.75                                | 0.75                               | 0.0                   |   |
| f)  | 50.40          | 630  | 361              | 60%   | 0.13%                                      | 0.7                                 | 0.7                                | 0.0                   |   |
| g)  | 50.00          | Maximal Rising Gradient [W/min]: <u>52.5</u> , Limitation [W/min]: <u>60</u>   |                  |   |  |                                     |                                    |                       |   |

| 5.4.6   |                | TABLE: Active power feeding of PGU at under frequency  |                                  |   |                                   |                                     |                                    |                                   | P |
|---|----------------|--|----------------------------------|---|-----------------------------------|-------------------------------------|------------------------------------|-----------------------------------|---|
| Equipment used: PVE-029, PVE-036, PVE-037, PVE-038, PVE-076, PVE-002, PVE-001, PVE-080, PVE-081, PVE-082, PVE-083 |                |  |                                  |   |                                   |                                     |                                    |                                   |   |
| Test No. 1:   |                |  |                                  |   |                                   |                                     |                                    |                                   |   |
| Power output:   |                |  | 10% P <sub>E<sub>max</sub></sub> |   |                                   |                                     |                                    |                                   |   |
| No.   | Frequency [Hz] | DC available power [W]   | Power output [W]                 | Target power [P/ P <sub>E<sub>max</sub></sub> ] | Deviation $\Delta P/ P_{E_{max}}$ | Rise time T <sub>rise_90%</sub> [s] | Settling time T <sub>set</sub> [s] | Response delay T <sub>v</sub> [s] |   |
| Limitation  |                | --   | --                               | --  | < ± 10%                           | < 2                                 | < 20                               | < 2                               |   |
| a)  | 50.00          | 630  | 52                               | 10%   | -1.36%                            | --                                  | --                                 | --                                |   |
| b)  | 49.75          | 630  | 65                               | 12%   | -1.12%                            | 0.4                                 | 0.4                                | 0.0                               |   |
| c)  | 48.80          | 630  | 309                              | 50%   | 1.48%                             | 0.4                                 | 0.4                                | 0.0                               |   |
| d)  | 47.60          | 630  | 596                              | 98%   | 1.28%                             | 1.55                                | 1.55                               | 0.0                               |   |
| e)  | 48.80          | 630  | 312                              | 50%   | 1.95%                             | 1.8                                 | 1.8                                | 0.0                               |   |
| f)  | 49.75          | 630  | 66                               | 12%   | -1.02%                            | 1.8                                 | 1.8                                | 0.0                               |   |
| g)  | 50.00          | 630  | 49                               | 10%   | -1.87%                            | 0.5                                 | 0.5                                | 0.0                               |   |
| h)  | 47.35          | Disconnection Time[ms]: <u>52</u> , Limitation[ms]: <u>200</u>   |                                  |   |                                   |                                     |                                    |                                   |   |
| i)  | 47.40          | Reconnection : <input type="checkbox"/> Yes/ <input checked="" type="checkbox"/> No, Limitation: No reconnection is allowed. |                                  |   |                                   |                                     |                                    |                                   |   |
| j)  | 50.00          | Maximal Rising Gradient [W/min]: <u>52.0</u> , Limitation [W/min]: <u>60</u>   |                                  |   |                                   |                                     |                                    |                                   |   |
| Test No. 2:   |                |  |                                  |   |                                   |                                     |                                    |                                   |   |
| Power output:   |                |  | 60% P <sub>E<sub>max</sub></sub> |   |                                   |                                     |                                    |                                   |   |
| No.   | Frequency [Hz] | DC available power [W]   | Power output [W]                 | Target power [P/ P <sub>E<sub>max</sub></sub> ] | Deviation $\Delta P/ P_{E_{max}}$ | Rise time T <sub>rise_90%</sub> [s] | Settling time T <sub>set</sub> [s] | Response delay T <sub>v</sub> [s] |   |
| Limitation  |                | --   | --                               | --  | < ± 10%                           | < 2                                 | < 20                               | < 2                               |   |
| a)  | 50.00          | 630  | 352                              | 60%   | -1.41%                            | --                                  | --                                 | --                                |   |
| b)  | 49.75          | 630  | 374                              | 62%   | 0.29%                             | 0.9                                 | 0.9                                | 0.8                               |   |
| c)  | 48.80          | 630  | 605                              | 100%  | 0.86%                             | 0.8                                 | 0.8                                | 0.0                               |   |
| d)  | 47.60          | 630  | 604                              | 100%  | 0.75%                             | --                                  | --                                 | --                                |   |
| e)  | 48.80          | 630  | 609                              | 100%  | 1.49%                             | --                                  | --                                 | --                                |   |
| f)  | 49.85          | 630  | 354                              | 60%   | -0.95%                            | 1.8                                 | 1.8                                | 0.0                               |   |
| g)  | 50.00          | 630  | 352                              | 60%   | -1.39%                            | --                                  | --                                 | --                                |   |

|         |  |   |
|---------|--|---|
| 5.4.8.1 | TABLE: Reactive power / displacement factor setting accuracy | P |
|---------|--|---|

Equipment used: PVE-029, PVE-036, PVE-037, PVE-038, PVE-076, PVE-002, PVE-001, PVE-080, PVE-081, PVE-082, PVE-083

Min.  $\text{Cos } \phi$  setting step:  $\pm 0.01$

| No. | Test condition     |       | Measurement |        |          |                    |                                 |                                       |
|-----|--------------------|-------|-------------|--------|----------|--------------------|---------------------------------|---------------------------------------|
|     | $\text{Cos } \phi$ | Power | U [V]       | P [kW] | Q [kVar] | $\text{cos } \phi$ | $\Delta Q / P_{E_{\text{max}}}$ | Limit $\Delta Q / P_{E_{\text{max}}}$ |

$\Sigma S_{E_{\text{max}}} \leq 4.6 \text{ kVA}$

|    |                        |                          |        |        |         |       |        |                |
|----|------------------------|--------------------------|--------|--------|---------|-------|--------|----------------|
| a) | 0.95<br>under-excited  | 50% $P_{E_{\text{max}}}$ | 230.65 | 302.95 | -91.03  | 0.958 | -0.46% | $\leq \pm 4\%$ |
|    |                        | $S_{E_{\text{max}}}$     | 231.05 | 589.89 | -181.52 | 0.956 | -1.03% | $\leq \pm 4\%$ |
|    | 0.975<br>under-excited | 50% $P_{E_{\text{max}}}$ | 230.63 | 304.86 | -64.87  | 0.978 | -0.32% | $\leq \pm 4\%$ |
|    |                        | $S_{E_{\text{max}}}$     | 231.06 | 595.45 | -124.13 | 0.979 | -1.58% | $\leq \pm 4\%$ |
| b) | 0.95<br>over-excited   | 50% $P_{E_{\text{max}}}$ | 230.71 | 301.73 | 91.46   | 0.957 | 0.39%  | $\leq \pm 4\%$ |
|    |                        | $S_{E_{\text{max}}}$     | 230.96 | 587.97 | 184.08  | 0.954 | 0.61%  | $\leq \pm 4\%$ |
|    | 0.975<br>over-excited  | 50% $P_{E_{\text{max}}}$ | 230.90 | 302.13 | 68.66   | 0.975 | -0.31% | $\leq \pm 4\%$ |
|    |                        | $S_{E_{\text{max}}}$     | 231.19 | 592.30 | 144.10  | 0.972 | -1.75% | $\leq \pm 4\%$ |

P-Q Diagram

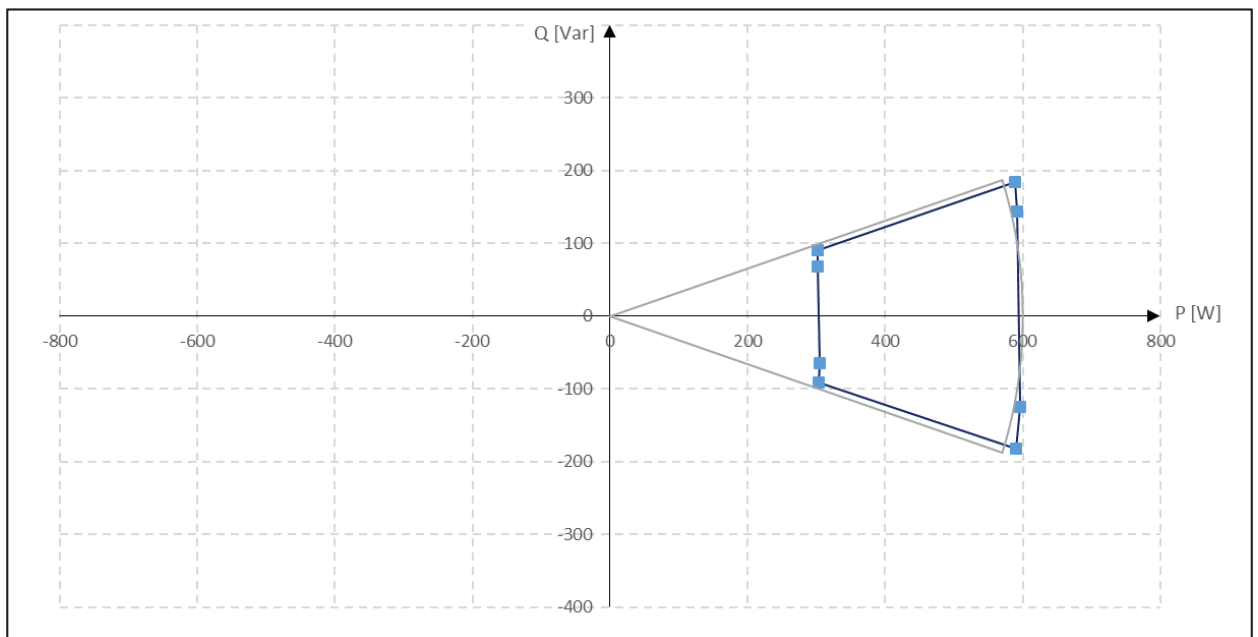

|         |   |   |
|---------|---|---|
| 5.4.8.2 | TABLE: Displacement factor- / active power character line $\cos\phi(P)$ | P |
|---------|---|---|

Equipment used: PVE-029, PVE-036, PVE-037, PVE-038, PVE-076, PVE-002, PVE-001, PVE-080, PVE-081, PVE-082, PVE-083

c) Test procedure for accuracy

$P_{Primary}$  Setting: 100%Pn -> 10%Pn -> 100%Pn

Limitation:  $\Delta Q / P_{Emax} \leq \pm 4\%$

Pass

Failed

$P_{DC}(t), P_{AC}(t), Q_{measure}(t), Q_{standard}(t), Q_{tolerance}(t)$

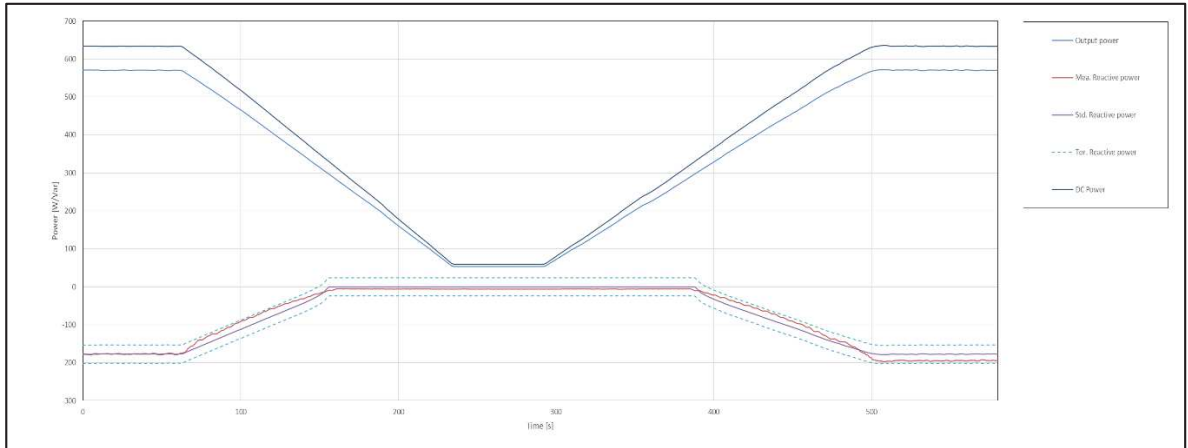

$\cos\phi(t)$

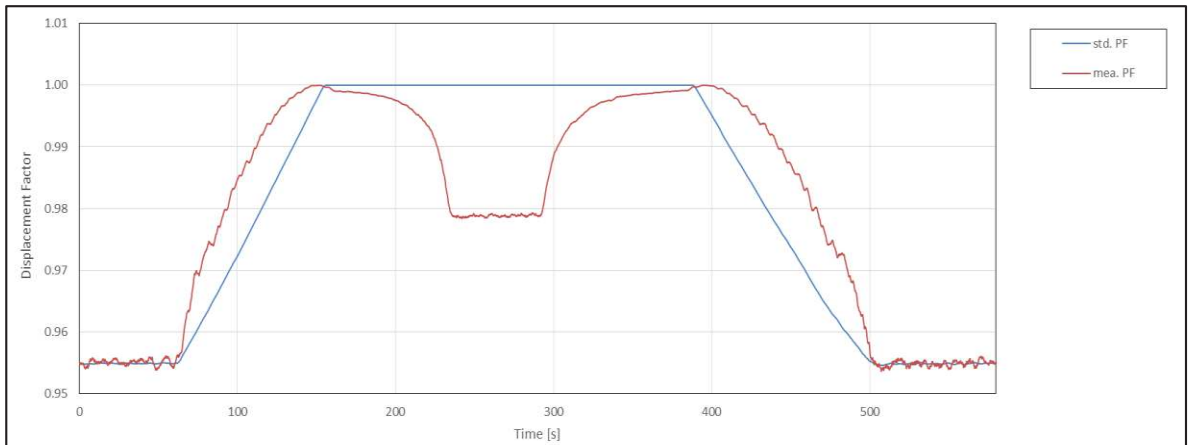

**d) Test procedure for dynamic**

| P/ P <sub>n</sub> [%] | Duration [s] | Dynamic as PT1 character ?   |
|-----------------------|--------------|--|
| 100                   | 60           | --   |
| 40                    | 60           | <input checked="" type="checkbox"/> Pass <input type="checkbox"/> Failed |
| 100                   | 60           | --   |
| 75                    | 60           | <input checked="" type="checkbox"/> Pass <input type="checkbox"/> Failed |

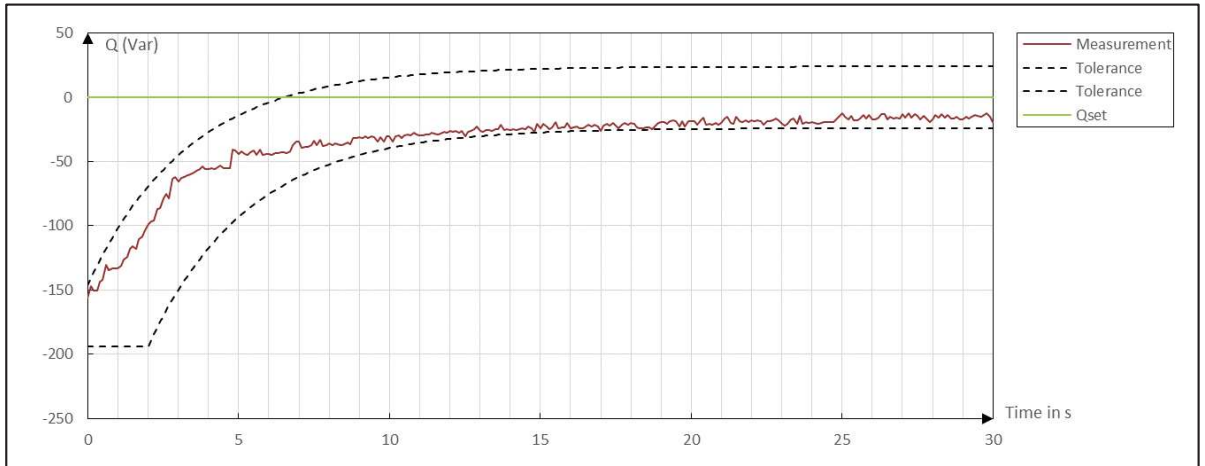
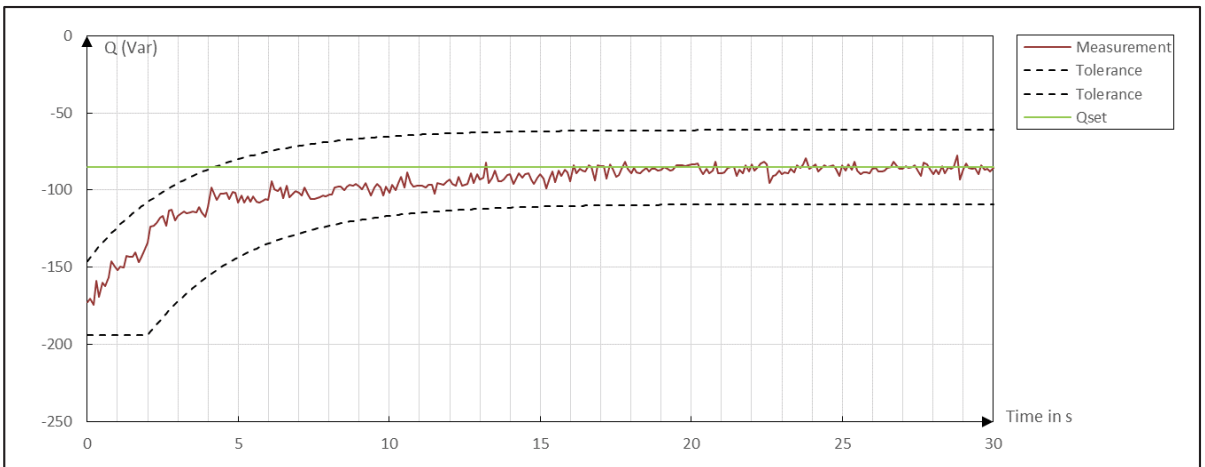
**Q(t), P<sub>Primary</sub> Setting: 100%P<sub>n</sub>->40%P<sub>n</sub>**

**Q(t), P<sub>Primary</sub> Setting: 100%P<sub>n</sub>->75%P<sub>n</sub>**

| 5.5.3, 5.5.4   |   | TABLE: Interface switch (Functional safety) |                  |           |          |   |  | P |
|--|---|---|------------------|-----------|----------|---|--|---|
| <input type="checkbox"/> Central interface switch                                |   |   |                  |           |          |   |  |   |
| Single fault type  |   |   |                  |           |          | A disconnection signal sent without delay ? |  |   |
| 1.   | Connection with a wrong equipment                           |   |                  |           |          | <input type="checkbox"/> Pass               | <input type="checkbox"/> Failed                            |   |
| 2.   | Connection interruption                                     |   |                  |           |          | <input type="checkbox"/> Pass               | <input type="checkbox"/> Failed                            |   |
| 3.   | Connection incorrect establish                              |   |                  |           |          | <input type="checkbox"/> Pass               | <input type="checkbox"/> Failed                            |   |
| 4.   | Interruption of power supply of interface switch            |   |                  |           |          | <input type="checkbox"/> Pass               | <input type="checkbox"/> Failed                            |   |
| 5.   | Trip the self-test of NS protection                         |   |                  |           |          | <input type="checkbox"/> Pass               | <input type="checkbox"/> Failed                            |   |
| Following information shall be stated in documentation of PGU:                   |   |   |                  |           |          |   |  |   |
| 1.   | The max. initial short-circuited current I <sub>k</sub> "': |   |                  |           |          | <input type="checkbox"/> Pass               | <input type="checkbox"/> Failed, _____ A                   |   |
| 2.   | The max. fuse   |   |                  |           |          | <input type="checkbox"/> Pass               | <input type="checkbox"/> Failed                            |   |
| 3.   | Connection plan includes necessary control signal           |   |                  |           |          | <input type="checkbox"/> Pass               | <input type="checkbox"/> Failed                            |   |
| <input checked="" type="checkbox"/> Integrated interface switch                  |   |   |                  |           |          |   |  |   |
| <input checked="" type="checkbox"/> Complied with DIN EN 62109-1/-2              |   |   |                  |           |          |   |  |   |
| Switch manufacturer: Zettler, Panasonic,   |   |   |                  |           |          |   |  |   |
| Switch type: Power relay + Inverter Mosfet (Isolated inverter)                   |   |   |                  |           |          |   |  |   |
| The max. initial short-circuited current of PGU I <sub>k</sub> "': <u>2.95</u> A |   |   |                  |           |          |   |  |   |
| No.  | component No.   | fault                                       | test voltage (V) | test time | fuse No. | fuse current (A)                            | result   |   |
| 1.   | Gird voltage sampling defect R103                           | s-c   | 36Vdc            | 10min     | --       | --  | Unit disconnect immediately, No damage, no hazard, no fire |   |
| 2.   | Gird voltage sampling defect R106                           | o-c   | 36Vdc            | 10min     | --       | --  | Unit disconnect immediately, No damage, no hazard, no fire |   |
| 3.   | Gird voltage sampling defect R103                           | o-c   | 36Vdc            | 10min     | --       | --  | Unit disconnect immediately, No damage, no hazard, no fire |   |
| 4.   | Gird voltage sampling defect R106                           | s-c   | 36Vdc            | 10min     | --       | --  | Unit disconnect immediately, No damage, no hazard, no fire |   |
| 5.   | Gird voltage sampling defect C67                            | s-c   | 36Vdc            | 10min     | --       | --  | Unit disconnect immediately, No damage, no hazard, no fire |   |
| 6.   | Communication interrupt Defect R29                          | o-c   | 36Vdc            | 10min     | --       | --  | Unit disconnect immediately, No damage, no hazard, no fire |   |
| 7.   | Communication interrupt Defect C55                          | s-c   | 36Vdc            | 10min     | --       | --  | Unit disconnect immediately, No damage, no hazard, no fire |   |
| 8.   | DC input voltage Monitoring Defect R33                      | s-c   | 36Vdc            | 10min     | --       | --  | Unit disconnect immediately, No damage, no hazard, no fire |   |

|     |   |                           |       |       |    |    |   |
|-----|---|---------------------------|-------|-------|----|----|---|
| 9.  | DC input voltage<br>Monitoring Defect<br>R189 | s-c                       | 36Vdc | 10min | -- | -- | Unit disconnect immediately, No<br>damage, no hazard, no fire |
| 10. | Gird voltage<br>Monitoring Defect<br>R164     | s-c                       | 36Vdc | 10min | -- | -- | Unit disconnect immediately, No<br>damage, no hazard, no fire |
| 11. | Gird voltage<br>Monitoring Defect<br>R165     | s-c                       | 36Vdc | 10min | -- | -- | Unit disconnect immediately, No<br>damage, no hazard, no fire |
| 12. | DSP power<br>C58                              | s-c                       | 36Vdc | 10min | -- | -- | Unit disconnect immediately, No<br>damage, no hazard, no fire |
| 13. | DSP power<br>C55                              | s-c                       | 36Vdc | 10min | -- | -- | Unit disconnect immediately, No<br>damage, no hazard, no fire |
| 14. | DSP power<br>C57                              | s-c                       | 36Vdc | 10min | -- | -- | Unit disconnect immediately, No<br>damage, no hazard, no fire |
| 15. | DSP power<br>C58                              | s-c                       | 36Vdc | 10min | -- | -- | Unit disconnect immediately, No<br>damage, no hazard, no fire |
| 16. | Relay fault defect<br>K1                      | s-c<br>before<br>start up | 36Vdc | 10min | -- | -- | Unit can't start, No damage, no<br>hazard, no fire            |



| 5.5.7   |                | TABLE: Protection device and settings |      |      |                 | P  |  |
|---|----------------|---------------------------------------|------|------|-----------------|--|--|
| Equipment used: PVE-029, PVE-036, PVE-037, PVE-038, PVE-076, PVE-002, PVE-001, PVE-080, PVE-081, PVE-082, PVE-083 |                |                                       |      |      |                 |  |  |
| OV Stage 2  | Set value [ms] | Trip time [ms]                        |      |      | Limitation [ms] | Test condition   |  |
|   |                | L1-N                                  | L2-N | L3-N |                 |  |  |
| 1   | 100            | 190                                   | N/A  | N/A  | ≤200            | Mains voltage is jumped from Un to 1.28Un.                                 |  |
| OV Stage 1  | Set value [ms] | Trip time [s]                         |      |      | Limitation [s]  | Test condition   |  |
|   |                |                                       |      |      |                 |  |  |
| 1   | 100            | 470                                   |      |      | ≤600            | Operation under nominal voltage for 10min, then jumped from Un to 1.12Un.  |  |
| 2   | 100            | No disconnection                      |      |      | No disconnect   | Operation under nominal voltage for 10min, then jumped from Un to 1.08Un.  |  |
| 3   | 100            | 245                                   |      |      | 225 - 375       | Operation under 1.06 voltage for 10min, then jumped from 1.06Un to 1.14Un. |  |
| UV Stage 2  | Set value [ms] | Trip time [ms]                        |      |      | Limitation [ms] | Test condition   |  |
|   |                | L1-N                                  | L2-N | L3-N |                 |  |  |
| 1   | 300            | No disconnect                         | N/A  | N/A  | No disconnect   | Mains voltage is jumped from Un to 0.48Un and keep for 500ms.              |  |
| 2   |                | 375                                   | N/A  | N/A  | ≤400            | Mains voltage is jumped from Un to 0.42Un and keep for 400ms.              |  |
| UV Stage 1  | Set value [ms] | Trip time [ms]                        |      |      | Limitation [ms] | Test condition   |  |
|   |                | L1-N                                  | L2-N | L3-N |                 |  |  |
| 1   | 3000           | No disconnect                         | N/A  | N/A  | No disconnect   | Mains voltage is jumped from Un to 0.83Un and keep for 60s.                |  |
| 2   |                | 3042                                  | N/A  | N/A  | ≤3100           | Mains voltage is jumped from Un to 0.77Un.                                 |  |

| OF  | Set value [ms] | Trip time        |  | Limitation [ms] | Remark   |
|-----|----------------|------------------|--|-----------------|--|
| No. |                | Measurement [ms] |  |                 |  |
| 1   | 100            | 190              |  | ≤200            | Mains frequency keep at 51.3Hz for 60s and then jumped to 51.7Hz |
| 2   |                | 198              |  |                 |  |
| 3   |                | 190              |  |                 |  |
| UF  | Set value [ms] | Trip time        |  | Limitation [ms] | Remark   |
| No. |                | Measurement [ms] |  |                 |  |
| 1   | 100            | 160              |  | ≤200            | Mains frequency keep at 47.7Hz for 60s and then jumped to 47.3Hz |
| 2   |                | 165              |  |                 |  |
| 3   |                | 159              |  |                 |  |

| 5.5.8, 5.5.9 |  | TABLE: Indication / protection of NS protection                          | P |
|--------------|--|--|---|
| 1.           | The last 5 fault indication can be read                                | <input checked="" type="checkbox"/> Pass <input type="checkbox"/> Failed |   |
|              | Fault 1:   | Over voltage fault, fault code: 800                                      |   |
|              | Fault 2:   | Over voltage fault, fault code: 800                                      |   |
|              | Fault 3:   | Over voltage fault, fault code: 800                                      |   |
|              | Fault 4:   | Over voltage fault, fault code: 800                                      |   |
|              | Fault 5:   | Over voltage fault, fault code: 800                                      |   |
| 2.           | Fault indication can be read after a supply interruption $\leq$ 3s     | <input checked="" type="checkbox"/> Pass <input type="checkbox"/> Failed |   |
|              | Fault 1:   | Over voltage fault, fault code: 800                                      |   |
|              | Fault 2:   | Over voltage fault, fault code: 800                                      |   |
|              | Fault 3:   | Over voltage fault, fault code: 800                                      |   |
|              | Fault 4:   | Over voltage fault, fault code: 800                                      |   |
|              | Fault 5:   | Over voltage fault, fault code: 800                                      |   |
| 3.           | The protection settings can be read on PGU or data interface equipment | <input checked="" type="checkbox"/> Pass <input type="checkbox"/> Failed |   |
|              |  | Interface equipment: computer  |   |
| 4.           | The NS protection settings shall be protected.                         | <input checked="" type="checkbox"/> Pass <input type="checkbox"/> Failed |   |
|              |  | Protection type: Password  |   |
| 5.           | If all protection settings are fixed                                   | <input checked="" type="checkbox"/> Pass <input type="checkbox"/> Failed |   |

| 5.5.10   |           | TABLE: Islanding detection (per IEC 62116: 2014) |             |       |                | P               |
|--|-----------|--|-------------|-------|----------------|-----------------|
| Equipment used: PVE-029, PVE-036, PVE-037, PVE-038, PVE-076, PVE-002, PVE-001, PVE-080, PVE-081, PVE-082, PVE-083, PVE-004 |           |  |             |       |                |                 |
| Power 100%   |           |  |             |       |                |                 |
| Conditions   | $P_R$ [W] | $Q_L$ [Var]                                      | $Q_C$ [Var] | $Q_f$ | Trip time [ms] | Limitation [ms] |
| PR: -10%<br>QC: +10%   | L1: 546   | L1: 603  | L1: 665     | 1.16  | 50             |                 |
|  | L2: 0     | L2: 0  | L2: 0       | 0.00  |                | 9000            |
|  | L3: 0     | L3: 0  | L3: 0       | 0.00  |                |                 |
| PR: -10%<br>QC: +5%  | L1: 546   | L1: 603  | L1: 633     | 1.13  | 135            |                 |
|  | L2: 0     | L2: 0  | L2: 0       | 0.00  |                | 9000            |
|  | L3: 0     | L3: 0  | L3: 0       | 0.00  |                |                 |
| PR: -10%<br>QC: 0%   | L1: 546   | L1: 603  | L1: 604     | 1.11  | 166            |                 |
|  | L2: 0     | L2: 0  | L2: 0       | 0.00  |                | 9000            |
|  | L3: 0     | L3: 0  | L3: 0       | 0.00  |                |                 |
| PR: -10%<br>QC: -5%  | L1: 546   | L1: 603  | L1: 574     | 1.08  | 239            |                 |
|  | L2: 0     | L2: 0  | L2: 0       | 0.00  |                | 9000            |
|  | L3: 0     | L3: 0  | L3: 0       | 0.00  |                |                 |
| PR: -10%   | L1: 546   | L1: 603  | L1: 544     | 1.05  | 835            |                 |

|                     |         |         |         |      |     |      |
|---------------------|---------|---------|---------|------|-----|------|
| QC: -10%            | L2: 0   | L2: 0   | L2: 0   | 0.00 |     | 9000 |
|                     | L3: 0   | L3: 0   | L3: 0   | 0.00 |     |      |
| PR: -5%<br>QC: +10% | L1: 577 | L1: 603 | L1: 665 | 1.10 | 34  |      |
|                     | L2: 0   | L2: 0   | L2: 0   | 0.00 |     | 9000 |
|                     | L3: 0   | L3: 0   | L3: 0   | 0.00 |     |      |
| PR: -5%<br>QC: -10% | L1: 577 | L1: 603 | L1: 544 | 0.99 | 876 |      |
|                     | L2: 0   | L2: 0   | L2: 0   | 0.00 |     | 9000 |
|                     | L3: 0   | L3: 0   | L3: 0   | 0.00 |     |      |
| PR: 0%<br>QC: +10%  | L1: 607 | L1: 603 | L1: 665 | 1.04 | 141 |      |
|                     | L2: 0   | L2: 0   | L2: 0   | 0.00 |     | 9000 |
|                     | L3: 0   | L3: 0   | L3: 0   | 0.00 |     |      |
| PR: -5%<br>QC: +5%  | L1: 577 | L1: 603 | L1: 635 | 1.07 | 119 |      |
|                     | L2: 0   | L2: 0   | L2: 0   | 0.00 |     | 9000 |
|                     | L3: 0   | L3: 0   | L3: 0   | 0.00 |     |      |
| PR: -5%<br>QC: 0%   | L1: 577 | L1: 603 | L1: 604 | 1.05 | 182 |      |
|                     | L2: 0   | L2: 0   | L2: 0   | 0.00 |     | 9000 |
|                     | L3: 0   | L3: 0   | L3: 0   | 0.00 |     |      |
| PR: -5%<br>QC: -5%  | L1: 577 | L1: 603 | L1: 574 | 1.02 | 251 |      |
|                     | L2: 0   | L2: 0   | L2: 0   | 0.00 |     | 9000 |
|                     | L3: 0   | L3: 0   | L3: 0   | 0.00 |     |      |
| PR: 0%<br>QC: +5%   | L1: 607 | L1: 603 | L1: 635 | 1.02 | 169 |      |
|                     | L2: 0   | L2: 0   | L2: 0   | 0.00 |     | 9000 |
|                     | L3: 0   | L3: 0   | L3: 0   | 0.00 |     |      |
| PR: 0%<br>QC: 0%    | L1: 607 | L1: 603 | L1: 604 | 1.00 | 182 |      |
|                     | L2: 0   | L2: 0   | L2: 0   | 0.00 |     | 9000 |
|                     | L3: 0   | L3: 0   | L3: 0   | 0.00 |     |      |
| PR: 0%<br>QC: -5%   | L1: 607 | L1: 603 | L1: 574 | 0.97 | 280 |      |
|                     | L2: 0   | L2: 0   | L2: 0   | 0.00 |     | 9000 |
|                     | L3: 0   | L3: 0   | L3: 0   | 0.00 |     |      |
| PR: +5%<br>QC: +5%  | L1: 637 | L1: 603 | L1: 635 | 0.97 | 170 |      |
|                     | L2: 0   | L2: 0   | L2: 0   | 0.00 |     | 9000 |
|                     | L3: 0   | L3: 0   | L3: 0   | 0.00 |     |      |
| PR: +5%<br>QC: 0%   | L1: 637 | L1: 603 | L1: 604 | 0.95 | 204 |      |
|                     | L2: 0   | L2: 0   | L2: 0   | 0.00 |     | 9000 |
|                     | L3: 0   | L3: 0   | L3: 0   | 0.00 |     |      |
| PR: +5%<br>QC: -5%  | L1: 637 | L1: 603 | L1: 574 | 0.92 | 330 |      |
|                     | L2: 0   | L2: 0   | L2: 0   | 0.00 |     | 9000 |
|                     | L3: 0   | L3: 0   | L3: 0   | 0.00 |     |      |
| PR: 0%              | L1: 607 | L1: 603 | L1: 544 | 0.94 | 321 |      |

| QC: -10%             | L2: 0   | L2: 0    | L2: 0    | 0.00 |                | 9000            |
|----------------------|---------|----------|----------|------|----------------|-----------------|
|                      | L3: 0   | L3: 0    | L3: 0    | 0.00 |                |                 |
| PR: +5%<br>QC: +10%  | L1: 637 | L1: 603  | L1: 665  | 0.99 | 141            | 9000            |
|                      | L2: 0   | L2: 0    | L2: 0    | 0.00 |                |                 |
|                      | L3: 0   | L3: 0    | L3: 0    | 0.00 |                |                 |
| PR: +5%<br>QC: -10%  | L1: 637 | L1: 603  | L1: 544  | 0.90 | 414            | 9000            |
|                      | L2: 0   | L2: 0    | L2: 0    | 0.00 |                |                 |
|                      | L3: 0   | L3: 0    | L3: 0    | 0.00 |                |                 |
| PR: +10%<br>QC: +10% | L1: 668 | L1: 603  | L1: 665  | 0.95 | 164            | 9000            |
|                      | L2: 0   | L2: 0    | L2: 0    | 0.00 |                |                 |
|                      | L3: 0   | L3: 0    | L3: 0    | 0.00 |                |                 |
| PR: +10%<br>QC: +5%  | L1: 668 | L1: 603  | L1: 635  | 0.93 | 183            | 9000            |
|                      | L2: 0   | L2: 0    | L2: 0    | 0.00 |                |                 |
|                      | L3: 0   | L3: 0    | L3: 0    | 0.00 |                |                 |
| PR: +10%<br>QC: 0%   | L1: 668 | L1: 603  | L1: 604  | 0.90 | 191            | 9000            |
|                      | L2: 0   | L2: 0    | L2: 0    | 0.00 |                |                 |
|                      | L3: 0   | L3: 0    | L3: 0    | 0.00 |                |                 |
| PR: +10%<br>QC: -5%  | L1: 668 | L1: 603  | L1: 574  | 0.88 | 373            | 9000            |
|                      | L2: 0   | L2: 0    | L2: 0    | 0.00 |                |                 |
|                      | L3: 0   | L3: 0    | L3: 0    | 0.00 |                |                 |
| PR: +10%<br>QC: -10% | L1: 668 | L1: 603  | L1: 544  | 0.86 | 342            | 9000            |
|                      | L2: 0   | L2: 0    | L2: 0    | 0.00 |                |                 |
|                      | L3: 0   | L3: 0    | L3: 0    | 0.00 |                |                 |
| Power 66%            |         |          |          |      |                |                 |
| Conditions           | PR [W]  | QL [Var] | QC [Var] | Qf   | Trip time [ms] | Limitation [ms] |
| PR: 0%<br>QC: -5%    | L1: 393 | L1: 395  | L1: 375  | 0.98 | 306            | 9000            |
|                      | L2: 0   | L2: 0    | L2: 0    | 0.00 |                |                 |
|                      | L3: 0   | L3: 0    | L3: 0    | 0.00 |                |                 |
| PR: 0%<br>QC: -4%    | L1: 393 | L1: 395  | L1: 379  | 0.99 | 340            | 9000            |
|                      | L2: 0   | L2: 0    | L2: 0    | 0.00 |                |                 |
|                      | L3: 0   | L3: 0    | L3: 0    | 0.00 |                |                 |
| PR: 0%<br>QC: -3%    | L1: 393 | L1: 395  | L1: 383  | 0.99 | 502            | 9000            |
|                      | L2: 0   | L2: 0    | L2: 0    | 0.00 |                |                 |
|                      | L3: 0   | L3: 0    | L3: 0    | 0.00 |                |                 |
| PR: 0%<br>QC: -2%    | L1: 393 | L1: 395  | L1: 387  | 1.00 | 690            | 9000            |
|                      | L2: 0   | L2: 0    | L2: 0    | 0.00 |                |                 |
|                      | L3: 0   | L3: 0    | L3: 0    | 0.00 |                |                 |
| PR: 0%<br>QC: -1%    | L1: 393 | L1: 395  | L1: 391  | 1.00 | 876            | 9000            |
|                      | L2: 0   | L2: 0    | L2: 0    | 0.00 |                |                 |

|                   | L3: 0   | L3: 0    | L3: 0    | 0.00 |                |                 |
|-------------------|---------|----------|----------|------|----------------|-----------------|
| PR: 0%<br>QC: 0%  | L1: 393 | L1: 395  | L1: 395  | 1.01 | 516            | 9000            |
|                   | L2: 0   | L2: 0    | L2: 0    | 0.00 |                |                 |
|                   | L3: 0   | L3: 0    | L3: 0    | 0.00 |                |                 |
| PR: 0%<br>QC: +1% | L1: 393 | L1: 395  | L1: 399  | 1.01 | 398            | 9000            |
|                   | L2: 0   | L2: 0    | L2: 0    | 0.00 |                |                 |
|                   | L3: 0   | L3: 0    | L3: 0    | 0.00 |                |                 |
| PR: 0%<br>QC: +2% | L1: 393 | L1: 395  | L1: 403  | 1.02 | 284            | 9000            |
|                   | L2: 0   | L2: 0    | L2: 0    | 0.00 |                |                 |
|                   | L3: 0   | L3: 0    | L3: 0    | 0.00 |                |                 |
| PR: 0%<br>QC: +3% | L1: 393 | L1: 395  | L1: 407  | 1.02 | 278            | 9000            |
|                   | L2: 0   | L2: 0    | L2: 0    | 0.00 |                |                 |
|                   | L3: 0   | L3: 0    | L3: 0    | 0.00 |                |                 |
| PR: 0%<br>QC: +4% | L1: 393 | L1: 395  | L1: 411  | 1.03 | 240            | 9000            |
|                   | L2: 0   | L2: 0    | L2: 0    | 0.00 |                |                 |
|                   | L3: 0   | L3: 0    | L3: 0    | 0.00 |                |                 |
| PR: 0%<br>QC: +5% | L1: 393 | L1: 395  | L1: 415  | 1.03 | 238            | 9000            |
|                   | L2: 0   | L2: 0    | L2: 0    | 0.00 |                |                 |
|                   | L3: 0   | L3: 0    | L3: 0    | 0.00 |                |                 |
| Power 33%         |         |          |          |      |                |                 |
| Conditions        | PR [W]  | QL [Var] | QC [Var] | Qf   | Trip time [ms] | Limitation [ms] |
| PR: 0%<br>QC: -5% | L1: 190 | L1: 194  | L1: 184  | 1.00 | 308            | 9000            |
|                   | L2: 0   | L2: 0    | L2: 0    | 0.00 |                |                 |
|                   | L3: 0   | L3: 0    | L3: 0    | 0.00 |                |                 |
| PR: 0%<br>QC: -4% | L1: 190 | L1: 194  | L1: 186  | 1.00 | 350            | 9000            |
|                   | L2: 0   | L2: 0    | L2: 0    | 0.00 |                |                 |
|                   | L3: 0   | L3: 0    | L3: 0    | 0.00 |                |                 |
| PR: 0%<br>QC: -3% | L1: 190 | L1: 194  | L1: 188  | 1.01 | 372            | 9000            |
|                   | L2: 0   | L2: 0    | L2: 0    | 0.00 |                |                 |
|                   | L3: 0   | L3: 0    | L3: 0    | 0.00 |                |                 |
| PR: 0%<br>QC: -2% | L1: 190 | L1: 194  | L1: 190  | 1.01 | 610            | 9000            |
|                   | L2: 0   | L2: 0    | L2: 0    | 0.00 |                |                 |
|                   | L3: 0   | L3: 0    | L3: 0    | 0.00 |                |                 |
| PR: 0%<br>QC: -1% | L1: 190 | L1: 194  | L1: 192  | 1.02 | 844            | 9000            |
|                   | L2: 0   | L2: 0    | L2: 0    | 0.00 |                |                 |
|                   | L3: 0   | L3: 0    | L3: 0    | 0.00 |                |                 |
| PR: 0%<br>QC: 0%  | L1: 190 | L1: 194  | L1: 194  | 1.02 | 500            | 9000            |
|                   | L2: 0   | L2: 0    | L2: 0    | 0.00 |                |                 |
|                   | L3: 0   | L3: 0    | L3: 0    | 0.00 |                |                 |

|                   |         |         |         |      |     |      |
|-------------------|---------|---------|---------|------|-----|------|
| PR: 0%<br>QC: +1% | L1: 190 | L1: 194 | L1: 196 | 1.03 | 474 | 9000 |
|                   | L2: 0   | L2: 0   | L2: 0   | 0.00 |     |      |
|                   | L3: 0   | L3: 0   | L3: 0   | 0.00 |     |      |
| PR: 0%<br>QC: +2% | L1: 190 | L1: 194 | L1: 198 | 1.03 | 548 | 9000 |
|                   | L2: 0   | L2: 0   | L2: 0   | 0.00 |     |      |
|                   | L3: 0   | L3: 0   | L3: 0   | 0.00 |     |      |
| PR: 0%<br>QC: +3% | L1: 190 | L1: 194 | L1: 200 | 1.04 | 316 | 9000 |
|                   | L2: 0   | L2: 0   | L2: 0   | 0.00 |     |      |
|                   | L3: 0   | L3: 0   | L3: 0   | 0.00 |     |      |
| PR: 0%<br>QC: +4% | L1: 190 | L1: 194 | L1: 202 | 1.04 | 262 | 9000 |
|                   | L2: 0   | L2: 0   | L2: 0   | 0.00 |     |      |
|                   | L3: 0   | L3: 0   | L3: 0   | 0.00 |     |      |
| PR: 0%<br>QC: +5% | L1: 190 | L1: 194 | L1: 204 | 1.05 | 238 | 9000 |
|                   | L2: 0   | L2: 0   | L2: 0   | 0.00 |     |      |
|                   | L3: 0   | L3: 0   | L3: 0   | 0.00 |     |      |

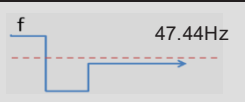
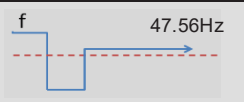
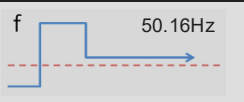
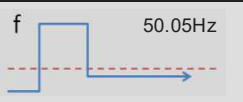
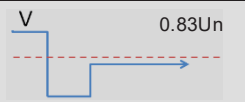
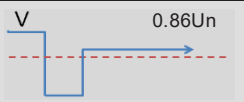
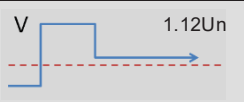
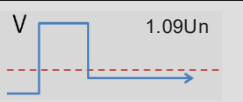
| 5.6                             | TABLE: Connection conditions and synchronisation                                    |  |   | P   |
|---------------------------------|---|--|---|---|
| Rated voltage: 230V, 50Hz       |   |  |   |   |
| Voltage detection accuracy [V]  | $\pm 1\%U_n$  |  | Frequency detection accuracy [Hz]   | $\pm 0.05$  |
| Specified recover voltage range | 0.85Un-1.1Un  |  | Specified recover frequency range   | 47.5-50.1   |
| Specified reconnect time [s]    | 60  |  | Limitation [s]  | $\geq 60$   |
| Conditions                      |  |  |  |  |
| Reconnect time [s]              | No reconnection   | 65   | No reconnection   | 65  |
| Conditions                      |  |  |  |  |
| Reconnect time [s]              | No reconnection   | 65   | No reconnection   | 66  |

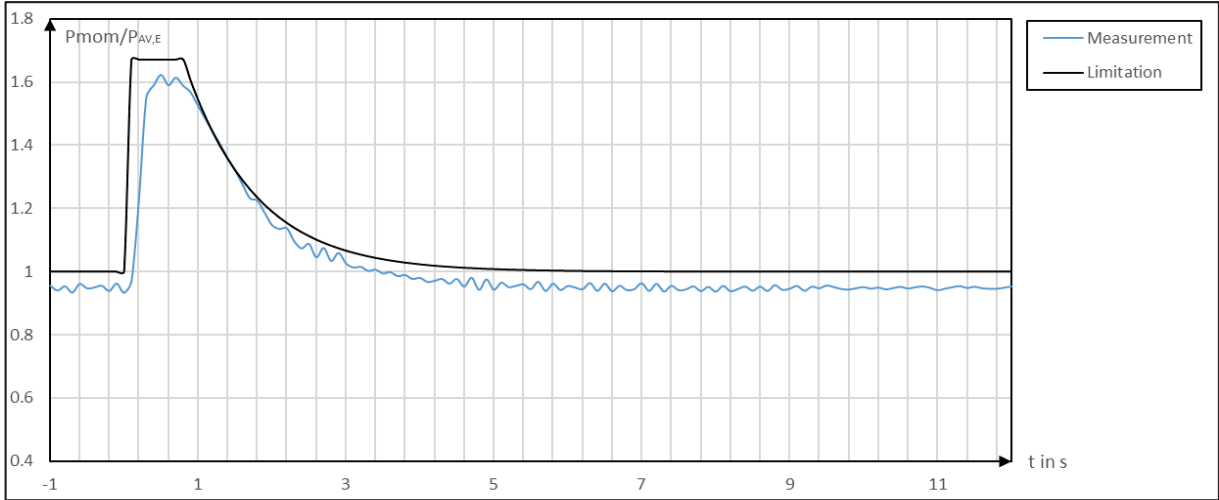
| 5.7   | TABLE: P <sub>AV,E</sub> monitoring  | P  |
|---|--|--|
| Equipment used: PVE-029, PVE-036, PVE-037, PVE-038, PVE-076, PVE-002, PVE-001, PVE-080, PVE-081, PVE-082, PVE-083 |  |  |
| P <sub>AV,E</sub> setting: 60% P <sub>n</sub>   |  |  |
| <input checked="" type="checkbox"/> Power limit method  |  |  |
| Test method   | Condition  | Power complied with limit curve  |
| <input checked="" type="checkbox"/> Jump of primary energy  | P <sub>dc</sub> : 60%P <sub>n</sub> jump to 100%P <sub>n</sub>                           | <input checked="" type="checkbox"/> Pass <input type="checkbox"/> Failed |
| <input type="checkbox"/> Cut of load  | P <sub>ac</sub> : 100%P <sub>n</sub> ,<br>P <sub>load</sub> : 40%P <sub>n</sub> cut to 0 | <input type="checkbox"/> Pass <input type="checkbox"/> Failed            |
| Power curve:  |  |  |
|                                |  |  |
| <input type="checkbox"/> Disconnection method   |  |  |
| Condition   | Trip time [ms]   |  |
|   | Measurement  | Limitation   |
| 0.98* P <sub>AV,E</sub>   |  | No disconnect  |
| 1.02 P <sub>AV,E</sub> - 1.067* P <sub>AV,E</sub>   |  | < 10000+200  |
| 1.067 P <sub>AV,E</sub> - 1.670* P <sub>AV,E</sub>  |  | < 3000 + 200   |
| 1.690* P <sub>AV,E</sub>  |  | < 200  |

| 5.8  |                              | Verification of dynamic network support |                                       |                      |                                  | P        |
|------|------------------------------|---|---------------------------------------|----------------------|----------------------------------|----------|
| Test | Voltage depth<br>U/Un [p.u.] | Fault type                              | Fault duration<br>[ms]                | Power<br>P/Pn [p.u.] | Reactive<br>power<br>Q/Pn [p.u.] | Test No. |
| 1    | 0.15.....0.25                | A                                       | For 0.15pu ≥ 150<br>For 0.25pu ≥ 500  | 1.0                  | 0...±0.1                         | 1.1      |
|      |                              |   |                                       | 0.2...0.6            |                                  | 1.2      |
|      |                              | D1                                      |                                       | 1.0                  |                                  | 1.3      |
|      |                              |   |                                       | 0.2...0.6            |                                  | 1.4      |
|      |                              | D2                                      |                                       | 1.0                  |                                  | 1.3 (2)  |
|      |                              |   |                                       | 0.2...0.6            |                                  | 1.4 (2)  |
| 2    | 0.50....0.60                 | A                                       | For 0.5pu ≥ 1500<br>For 0.60pu ≥ 2000 | 1.0                  | Max. over-<br>excited            | 2.1      |
|      |                              |   |                                       | 0.2...0.6            |                                  | 2.2      |
|      |                              | D1                                      |                                       | 1.0                  |                                  | 2.3      |
|      |                              |   |                                       | 0.2...0.6            |                                  | 2.4      |
| 3    | 0.50....0.60                 | A                                       | For 0.5pu ≥ 1500<br>For 0.60pu ≥ 2000 | 1.0                  | Max. under-<br>excited           | 3.1      |
|      |                              |   |                                       | 0.2...0.6            |                                  | 3.2      |
|      |                              | D1                                      |                                       | 1.0                  |                                  | 3.3      |
|      |                              |   |                                       | 0.2...0.6            |                                  | 3.4      |
| 4    | 0.85....0.90                 | A                                       | ≥ 60000                               | 1.0                  | 0...±0.1                         | 4.1      |
|      |                              |   |                                       | 0.2...0.6            |                                  | 4.2      |
|      |                              | D1                                      |                                       | 1.0                  |                                  | 4.3      |
|      |                              |   |                                       | 0.2...0.6            |                                  | 4.4      |
| 5    | 1.2....1.25                  | A                                       | ≥ 100                                 | 1.0                  | 0...±0.1                         | 5.1      |
|      |                              |   |                                       | 0.2...0.6            |                                  | 5.2      |
|      |                              | D1                                      |                                       | 1.0                  |                                  | 5.3      |
|      |                              |   |                                       | 0.2...0.6            |                                  | 5.4      |
|      |                              | D2                                      |                                       | 1.0                  |                                  | 5.3 (2)  |
|      |                              |   |                                       | 0.2...0.6            |                                  | 5.4 (2)  |
| 6    | 1.15...1.20                  | A                                       | ≥ 5000                                | 1.0                  | 0...±0.1                         | 6.1      |
|      |                              |   |                                       | 0.2...0.6            |                                  | 6.2      |
|      |                              | D1                                      |                                       | 1.0                  |                                  | 6.3      |
|      |                              |   |                                       | 0.2...0.6            |                                  | 6.4      |
| 7    | 1.10...1.15                  | A                                       | ≥ 60000                               | 1.0                  | 0...±0.1                         | 7.1      |
|      |                              |   |                                       | 0.2...0.6            |                                  | 7.2      |
|      |                              | D1                                      |                                       | 1.0                  |                                  | 7.3      |
|      |                              |   |                                       | 0.2...0.6            |                                  | 7.4      |



Equipment used: PVE-029, PVE-036, PVE-037, PVE-038, PVE-076, PVE-002, PVE-001, PVE-080, PVE-081, PVE-082, PVE-083, PVE-017

Test bench diagram:

$R_{netz}$ : 4.0Ohm,  $X_{netz}$ : 3.14Ohm

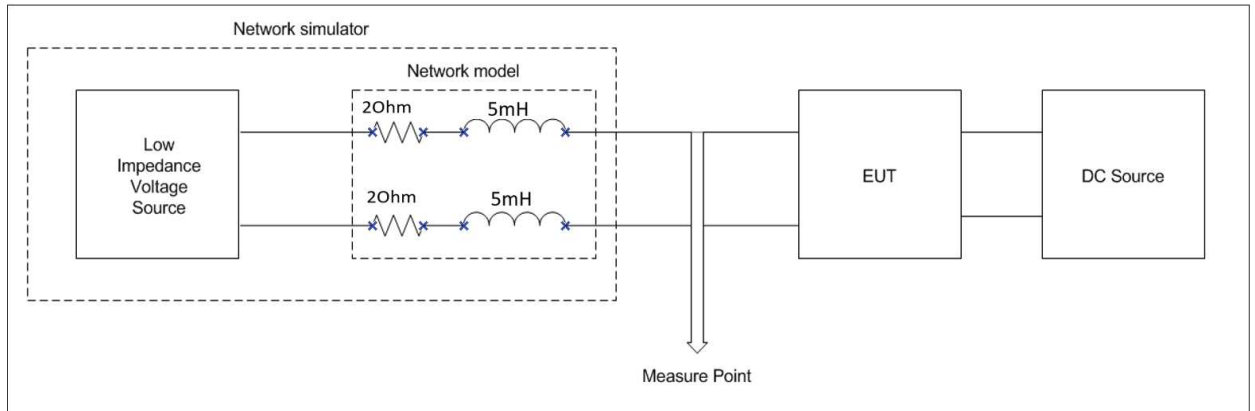

FRT curve settings:

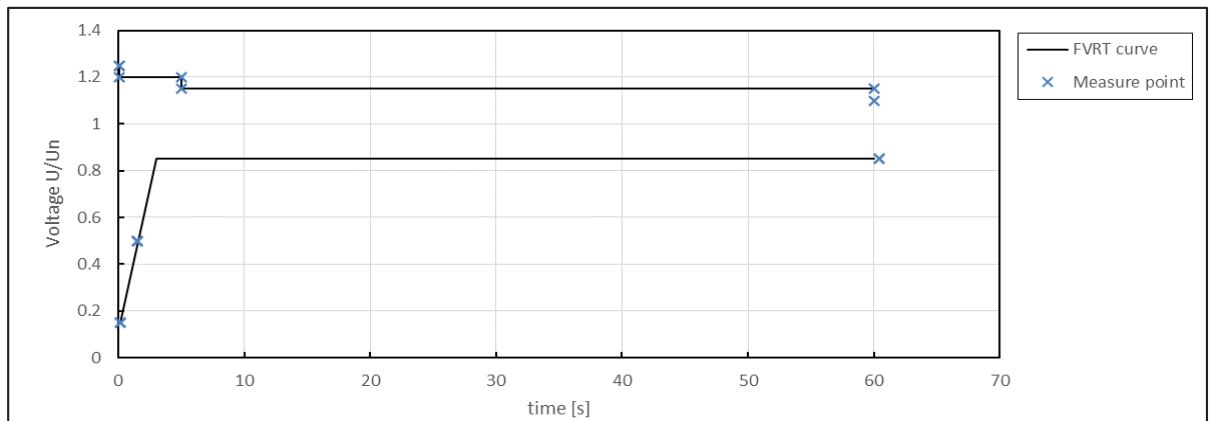

|  |   |
|--|---|
| Fault Type   | 3-phase fault and 2-phase fault                                     |
| Transformer Type                                   | Dy5   |
| Short-circuited power at generator terminal [kVA]  | 10.39   |
| Sk / Sn  | 17.3  |
| R / X  | 1.27  |
| NS protection settings                             | See table 5.5.7 for detail.   |
| Any auxilliary power supply in fault ride through? | <input type="checkbox"/> Yes <input checked="" type="checkbox"/> No |
| Terminal sequence                                  | For D1: U-L1, V-L2, W-L3<br>For D2: U-L3, V-L1, W-L2                |

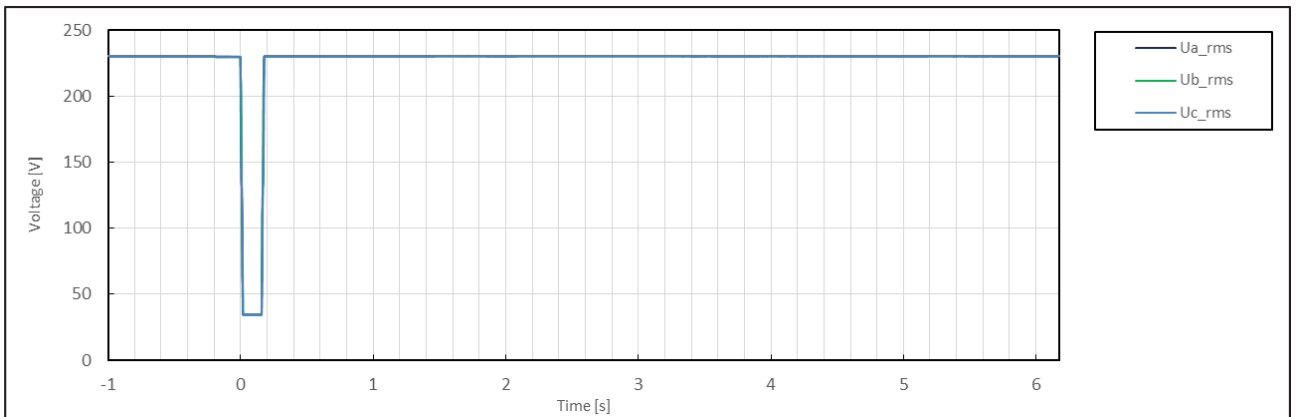
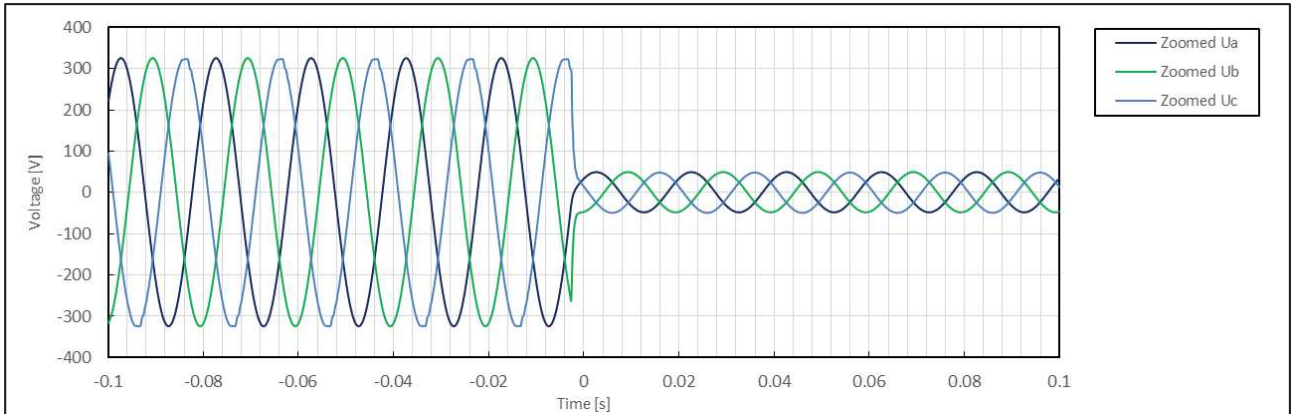
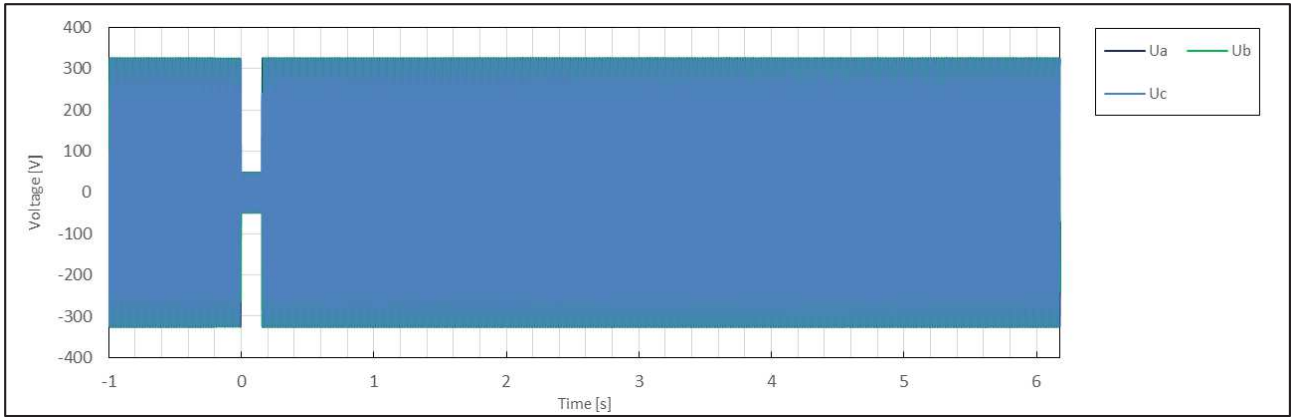

Test No. 1.1 with PGU

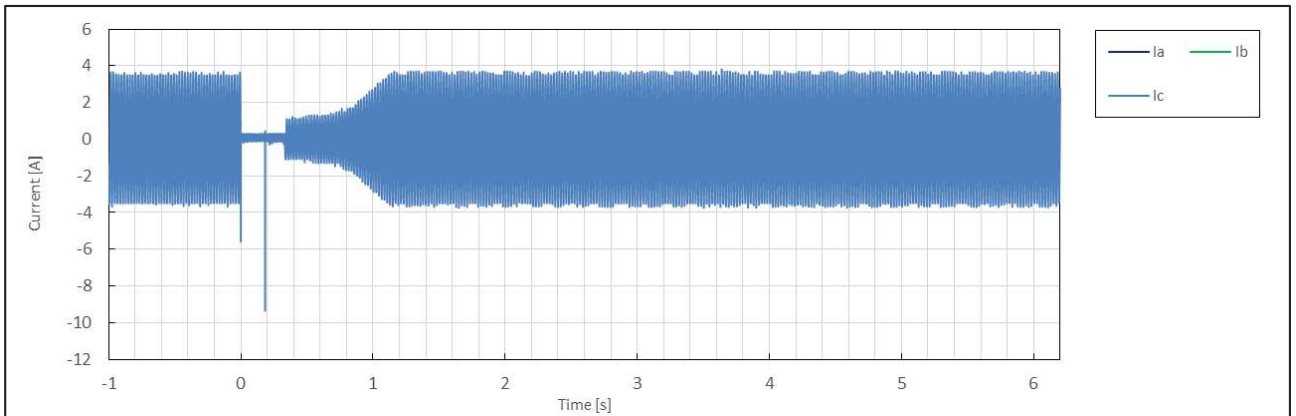
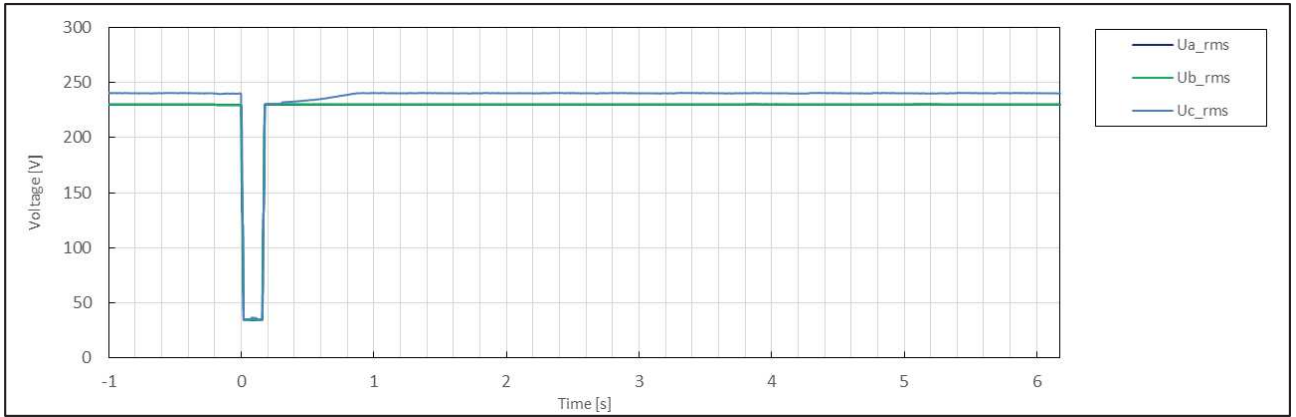
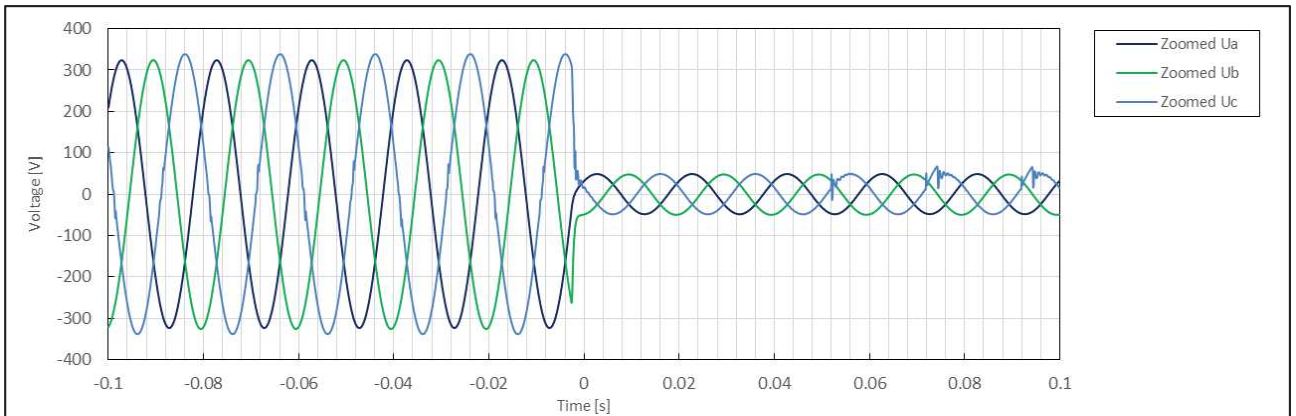
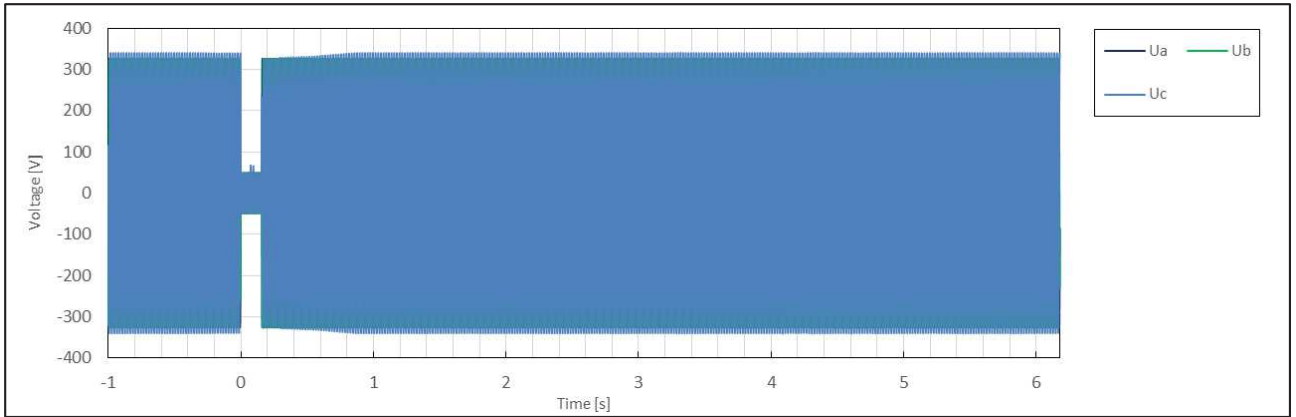

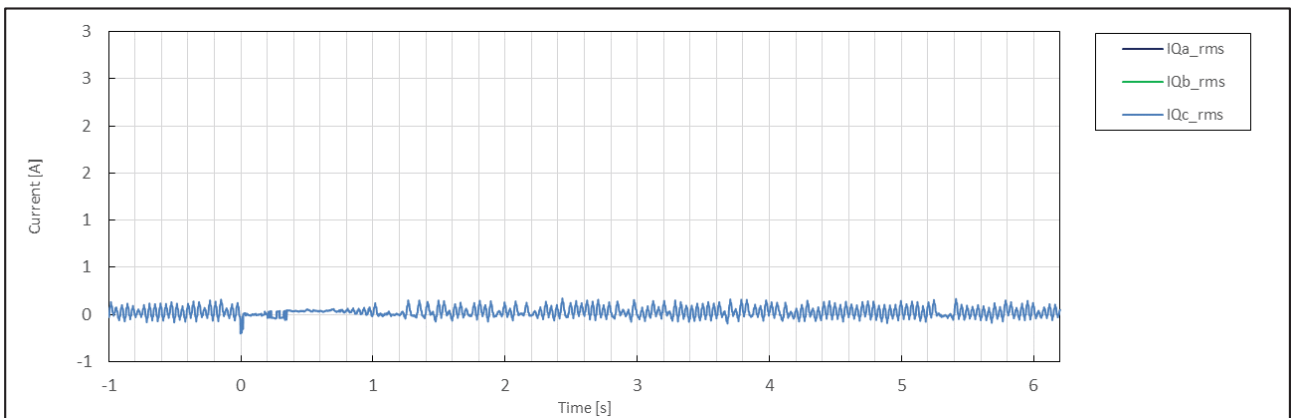
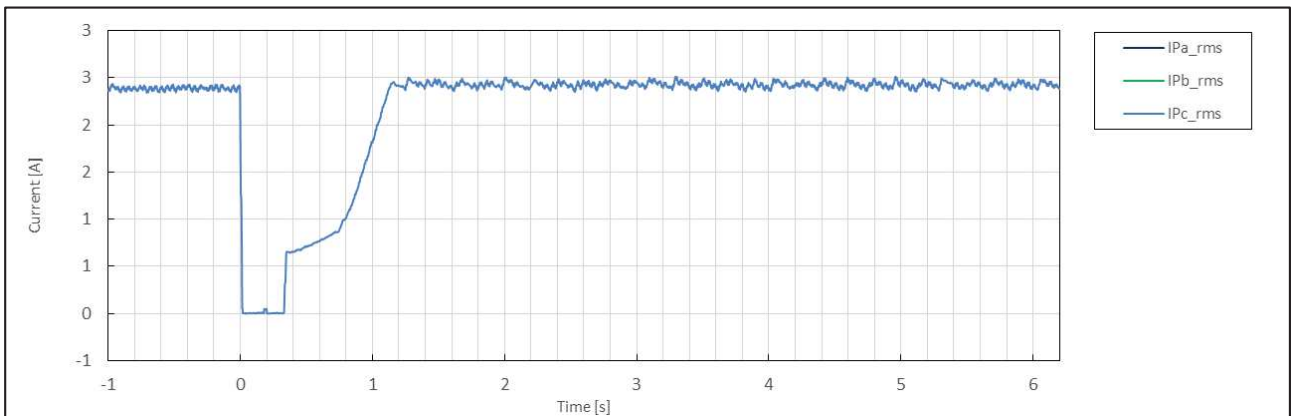
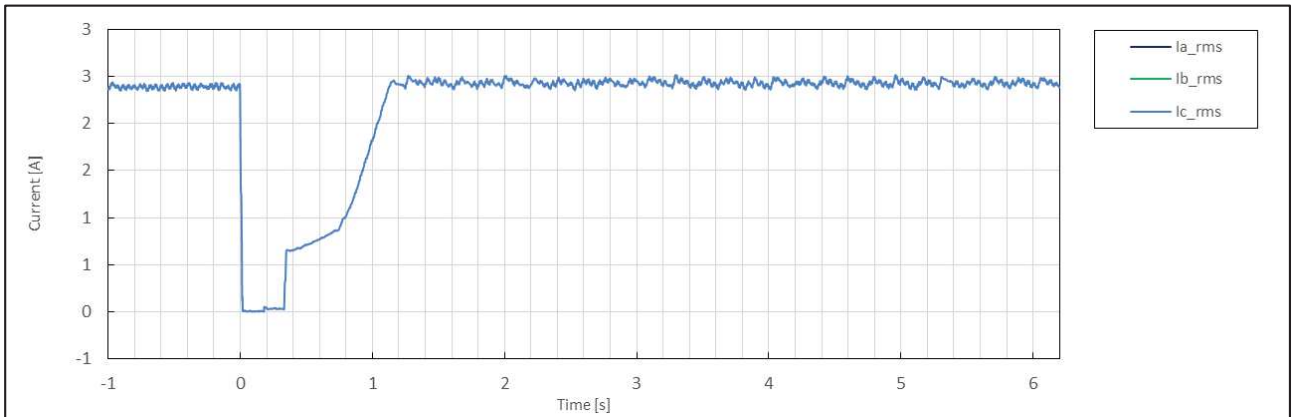
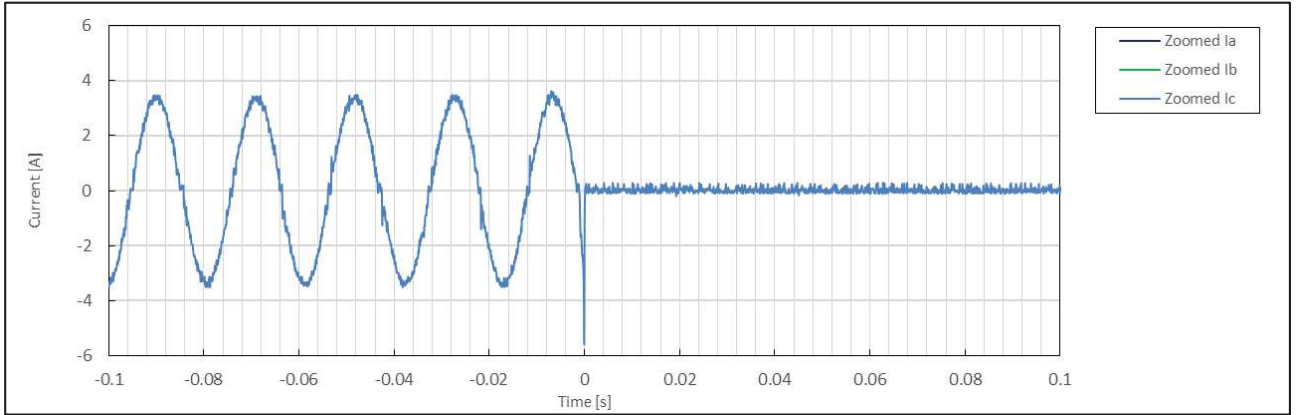

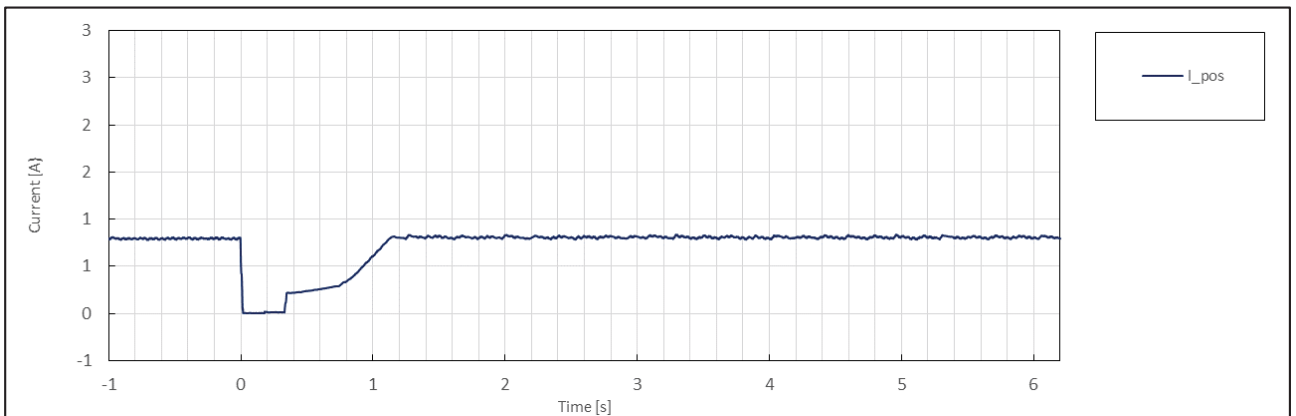
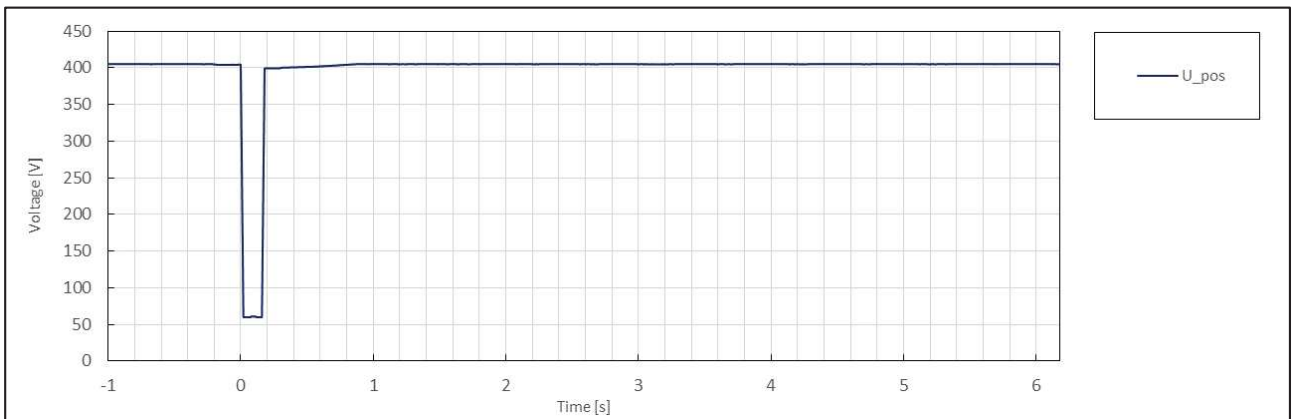
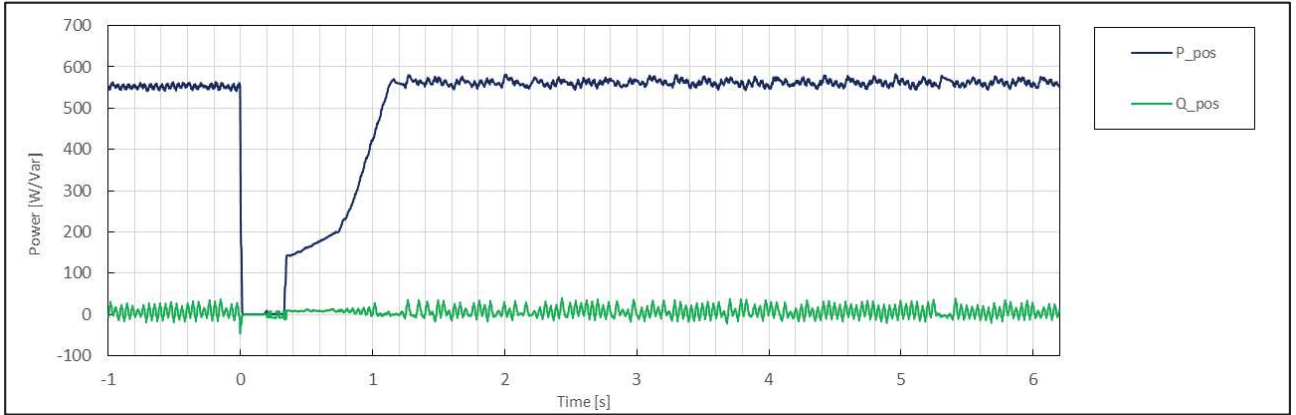

|                     | No. | Parameter  | Phase ref.      | Time ref.                       | unit       | Result        |
|---------------------|-----|--|-----------------|---------------------------------|------------|---------------|
| General Info.       | 0   | Test number  | --              | --                              | --         | 1.2           |
|                     | 1   | Date   | --              | --                              | dd.mm.yyyy | 3.1.2020      |
|                     | 2   | Time (start of test)                                   | --              | --                              | hh:mm:ss.f | 13:07:16      |
|                     | 3   | Fault type (phase)                                     | --              | --                              |            | 3-phase fault |
|                     | 4   | Setting voltage depth                                  | Line to line    | --                              | p.u.       | 0.15          |
|                     | 5   | Setting dip duration                                   |                 | --                              |            | 177           |
|                     | 6   | Point of fault entry                                   | Total           | --                              | ms         | 0             |
|                     | 7   | Point of fault clearance                               | Total           | --                              | ms         | 176           |
|                     | 8   | Fault duration in empty load test                      | Total           | --                              | ms         | 177           |
|                     | 9   | Voltage depth/height in empty load test                | Total           | t1+100ms to t2 and t1-10s to t1 | p.u.       | 0.15          |
|                     | 10  |  | Pos.            |                                 | p.u.       | 0.15          |
| Before dip <t1      | 11  | Voltage  | Line to neutral | t1-100s to t1                   | p.u.       | 1.01          |
|                     | 12  | Current  | Pos.            | t1-500ms to t1-100ms            | p.u.       | 0.11          |
|                     | 13  | Active power   | Total           | t1-10s to t1                    | p.u.       | 0.33          |
|                     | 14  |  | Pos.            |                                 |            | 0.33          |
|                     | 15  | Reactive power   | Total           | t1-10s to t1                    | p.u.       | 0.04          |
|                     | 16  |  | Pos.            |                                 |            | 0.04          |
|                     | 17  | Cos $\phi$   | --              | t1-10s to t1                    | --         | 0.994         |
| During dip t1 to t2 | 18  | Voltage  | Line to neutral | t1+100ms to t2-20ms             | p.u.       | 0.15          |
|                     | 19  | Line current   | Phase 1         | t1+60ms                         | p.u.       | N/A           |
|                     | 20  |  | Phase 2         |                                 |            | N/A           |
|                     | 21  |  | Phase 3         |                                 |            | 0.00          |
|                     | 22  | Line current   | Phase 1         | t1+100ms                        | p.u.       | N/A           |
|                     | 23  |  | Phase 2         |                                 |            | N/A           |
|                     | 24  |  | Phase 3         |                                 |            | 0.00          |
|                     | 25  | Active power   | Total           | t1+100ms to t2-20ms             | p.u.       | 0.00          |
|                     | 26  |  | Pos.            |                                 |            | 0.00          |
| After dip > t2      | 27  | Voltage  | Line to neutral | t2+3s to t2+10s                 | p.u.       | 1.01          |
|                     | 28  | Active power   | Total           | t2+3s to t2+10s                 | p.u.       | 0.33          |
|                     | 29  |  | Pos.            |                                 |            | 0.33          |
|                     | 39  | Active power rising time                               | Pos.            | --                              | s          | 0.881         |
|                     | 31  | Reactive power   | Total           | t2+3s to t2+10s                 | p.u.       | 0.04          |
|                     | 32  |  | Pos.            |                                 |            | 0.04          |
|                     | 33  | Reactive power rising time                             | Pos.            | --                              | s          | N/A           |
|                     | 34  | PGU does not disconnect from grid till 60s after fault | --              | t2 to t2+60s                    | Yes / No   | No            |

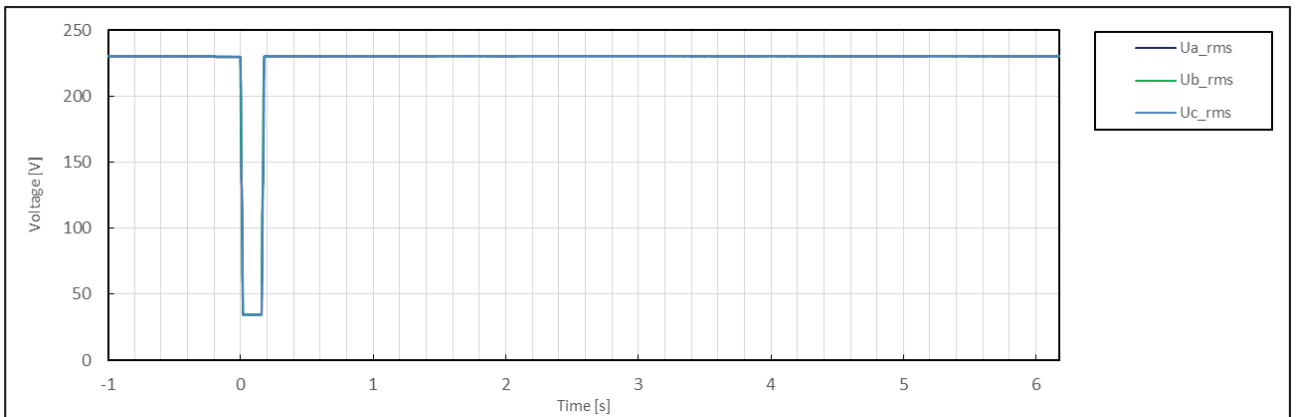
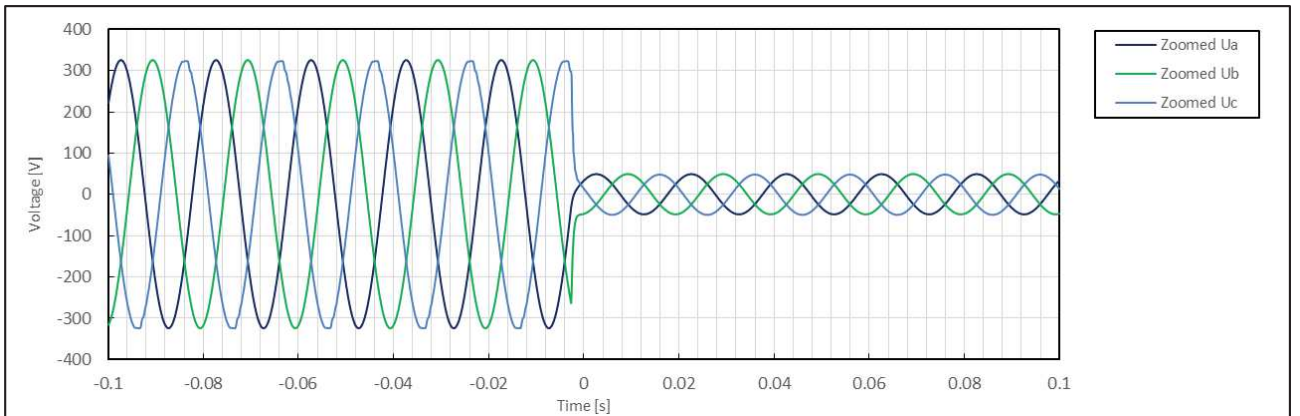
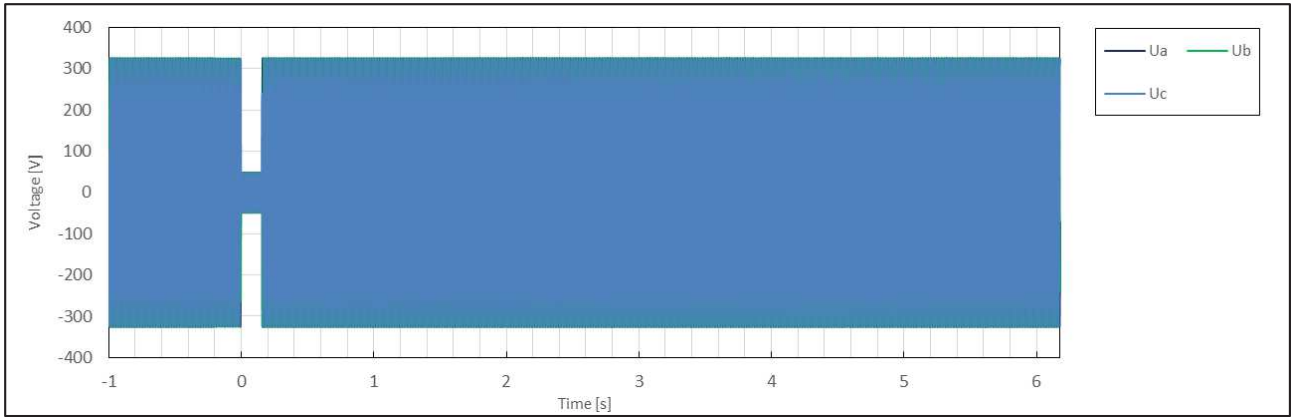

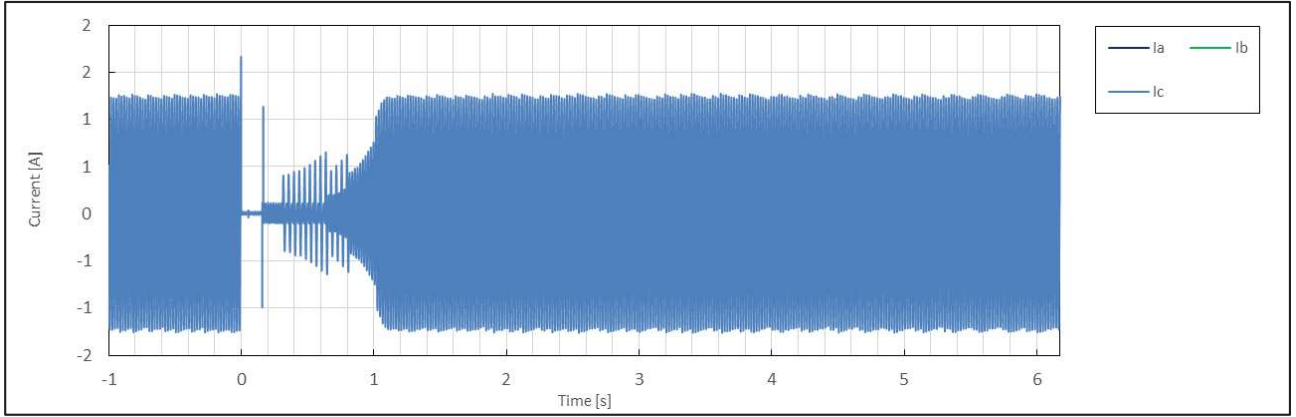
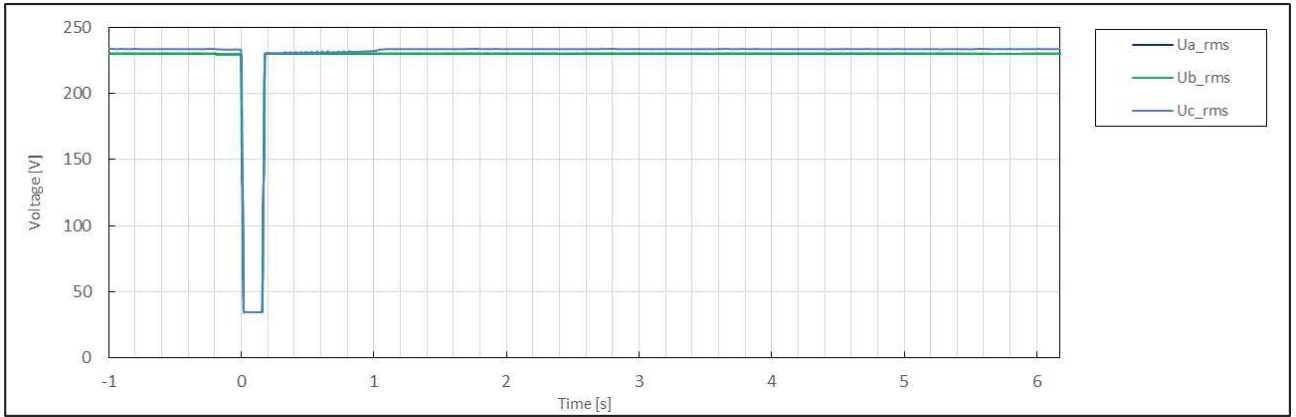
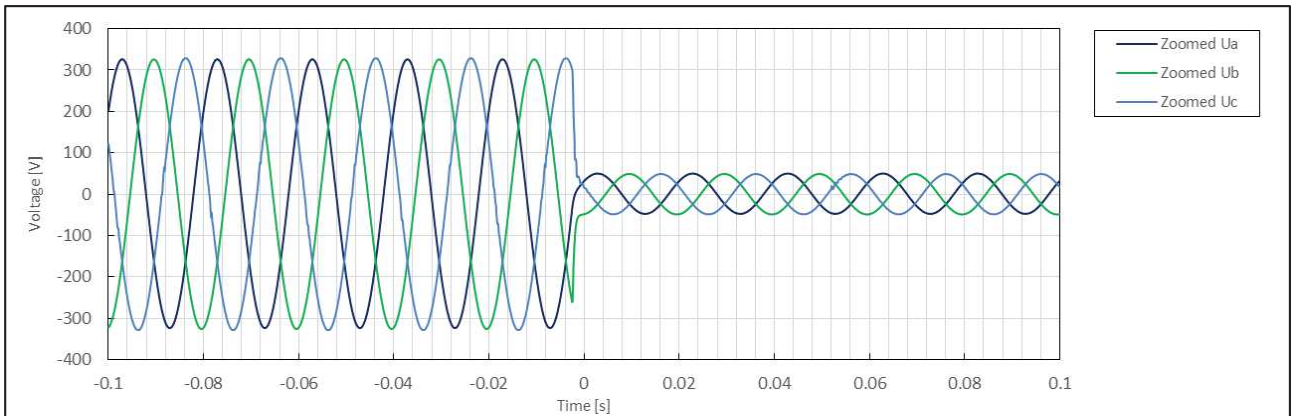
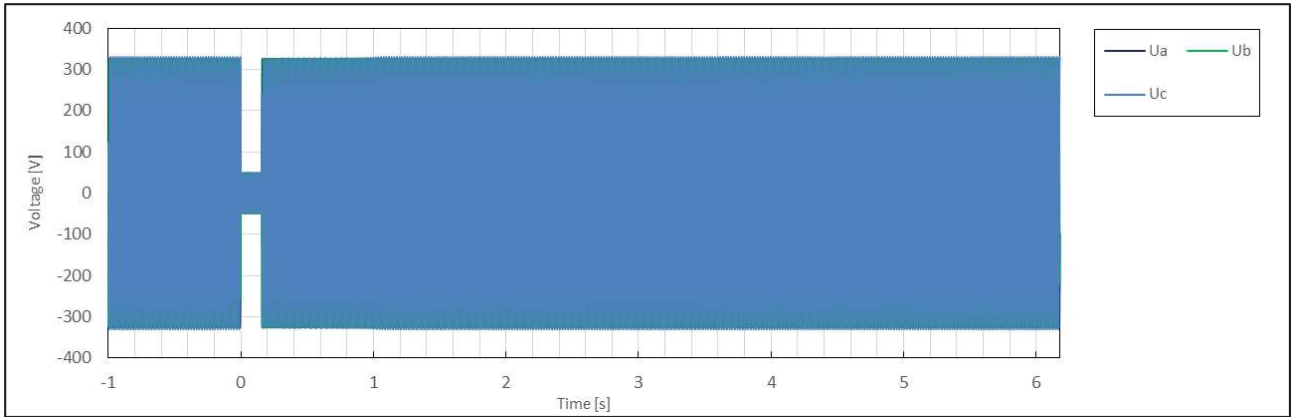



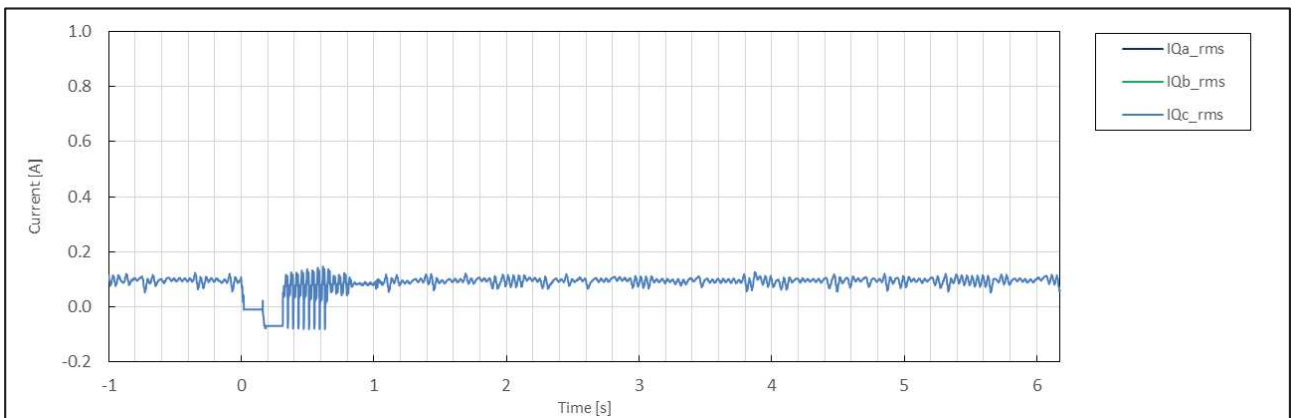
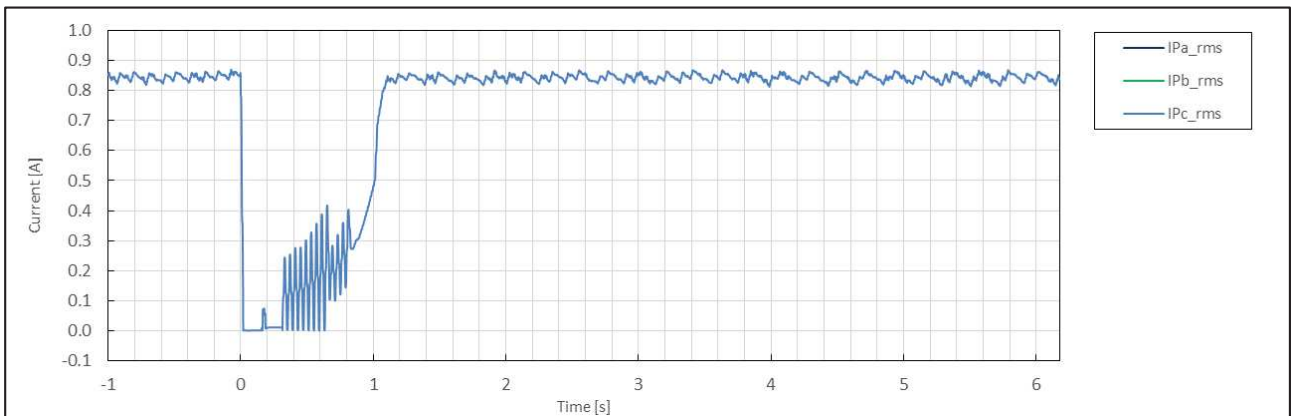
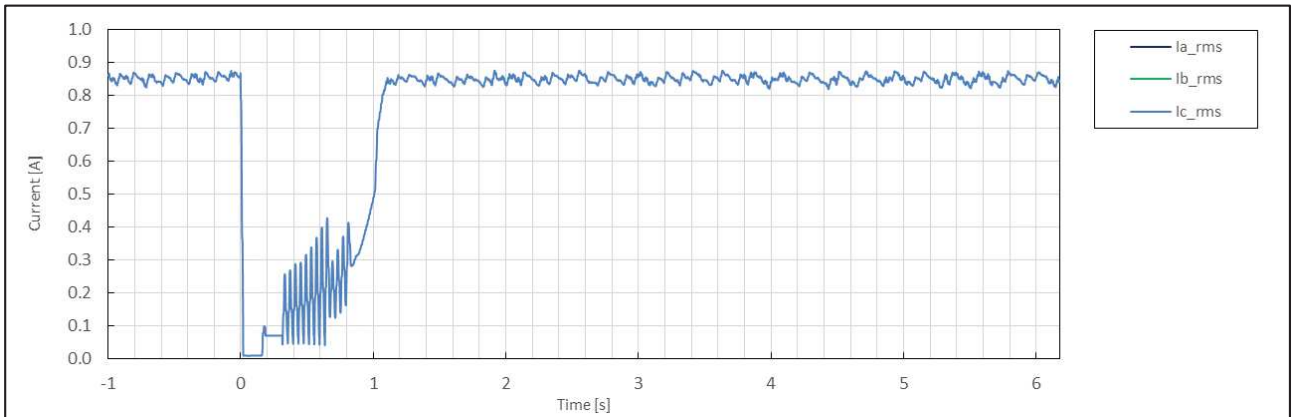
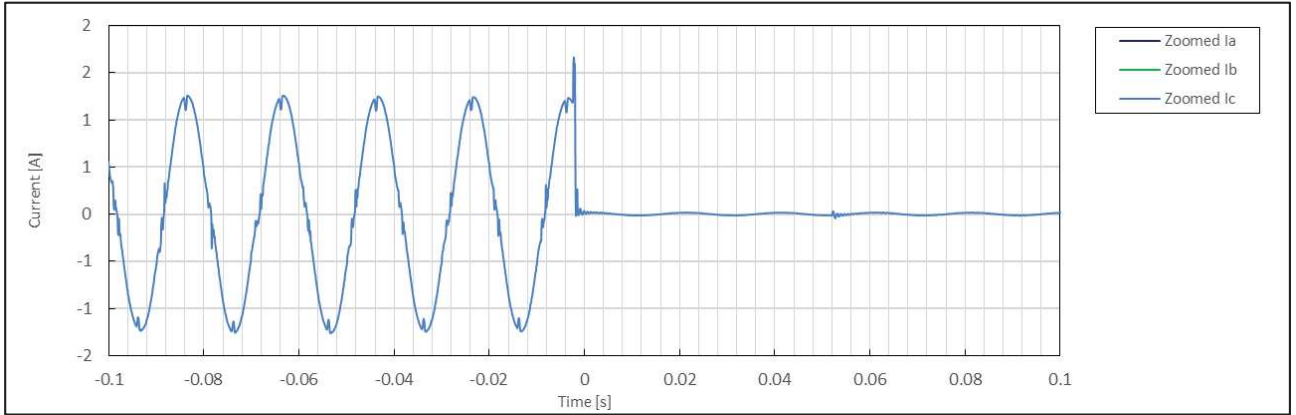

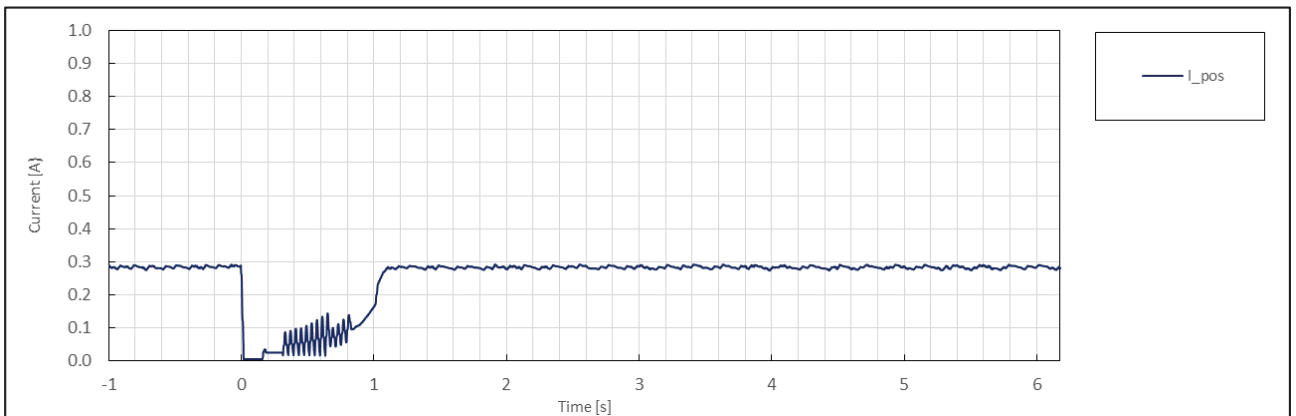
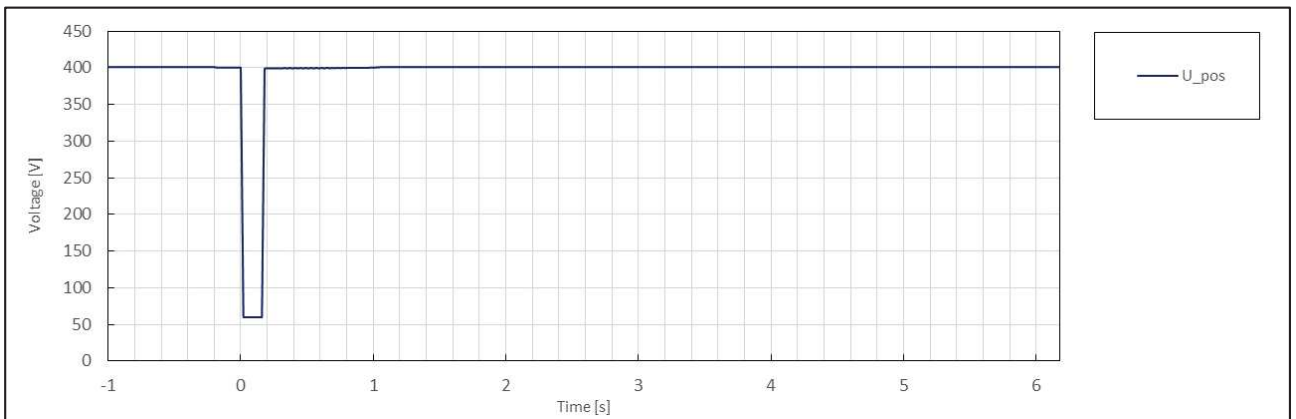
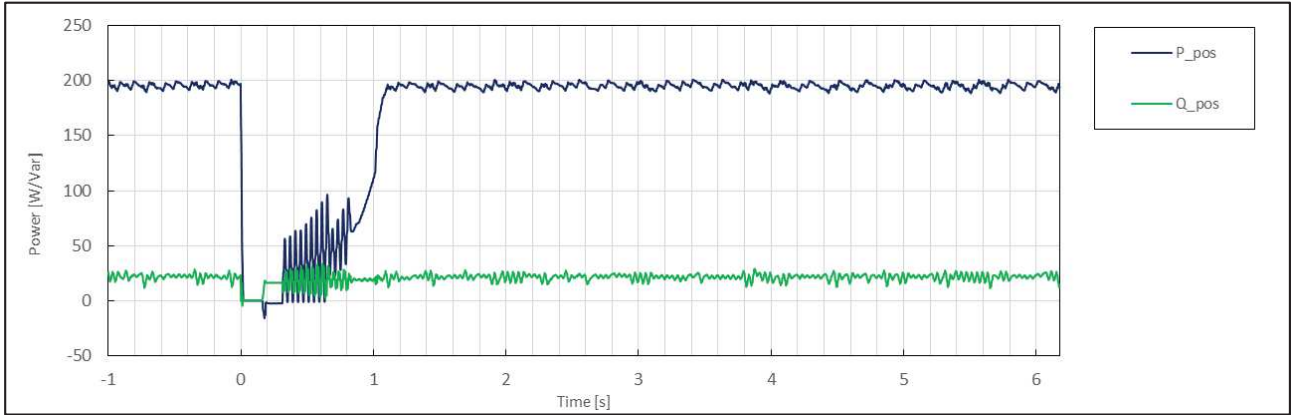

|                     | No. | Parameter  | Phase ref.      | Time ref.                       | unit       | Result        |
|---------------------|-----|--|-----------------|---------------------------------|------------|---------------|
| General Info.       | 0   | Test number  | --              | --                              | --         | 1.3           |
|                     | 1   | Date   | --              | --                              | dd.mm.yyyy | 3.1.2020      |
|                     | 2   | Time (start of test)                                   | --              | --                              | hh:mm:ss.f | 13:09:18      |
|                     | 3   | Fault type (phase)                                     | --              | --                              |            | 2-phase fault |
|                     | 4   | Setting voltage depth                                  | Line to line    | --                              | p.u.       | 0.15          |
|                     | 5   | Setting dip duration                                   |                 | --                              |            | 173           |
|                     | 6   | Point of fault entry                                   | Total           | --                              | ms         | 0             |
|                     | 7   | Point of fault clearance                               | Total           | --                              | ms         | 172           |
|                     | 8   | Fault duration in empty load test                      | Total           | --                              | ms         | 173           |
|                     | 9   | Voltage depth/height in empty load test                | Total           | t1+100ms to t2 and t1-10s to t1 | p.u.       | 0.62          |
|                     | 10  |  | Pos.            |                                 | p.u.       | 0.43          |
| Before dip <t1      | 11  | Voltage  | Line to neutral | t1-100s to t1                   | p.u.       | 1.02          |
|                     | 12  | Current  | Pos.            | t1-500ms to t1-100ms            | p.u.       | 0.32          |
|                     | 13  | Active power   | Total           | t1-10s to t1                    | p.u.       | 1.01          |
|                     | 14  |  | Pos.            |                                 |            | 0.98          |
|                     | 15  | Reactive power   | Total           | t1-10s to t1                    | p.u.       | 0.05          |
|                     | 16  |  | Pos.            |                                 |            | 0.05          |
|                     | 17  | Cos $\phi$   | --              | t1-10s to t1                    | --         | 0.999         |
| During dip t1 to t2 | 18  | Voltage  | Line to neutral | t1+100ms to t2-20ms             | p.u.       | 0.62          |
|                     | 19  | Line current   | Phase 1         | t1+60ms                         | p.u.       | N/A           |
|                     | 20  |  | Phase 2         |                                 |            | N/A           |
|                     | 21  |  | Phase 3         |                                 |            | 0.02          |
|                     | 22  | Line current   | Phase 1         | t1+100ms                        | p.u.       | N/A           |
|                     | 23  |  | Phase 2         |                                 |            | N/A           |
|                     | 24  |  | Phase 3         |                                 |            | 0.02          |
|                     | 25  | Active power   | Total           | t1+100ms to t2-20ms             | p.u.       | 0.00          |
|                     | 26  |  | Pos.            |                                 |            | 0.00          |
| After dip > t2      | 27  | Voltage  | Line to neutral | t2+3s to t2+10s                 | p.u.       | 1.02          |
|                     | 28  | Active power   | Total           | t2+3s to t2+10s                 | p.u.       | 1.01          |
|                     | 29  |  | Pos.            |                                 |            | 0.98          |
|                     | 39  | Active power rising time                               | Pos.            | --                              | s          | 0.485         |
|                     | 31  | Reactive power   | Total           | t2+3s to t2+10s                 | p.u.       | 0.05          |
|                     | 32  |  | Pos.            |                                 |            | 0.05          |
|                     | 33  | Reactive power rising time                             | Pos.            | --                              | s          | N/A           |
|                     | 34  | PGU does not disconnect from grid till 60s after fault | --              | t2 to t2+60s                    | Yes / No   | No            |

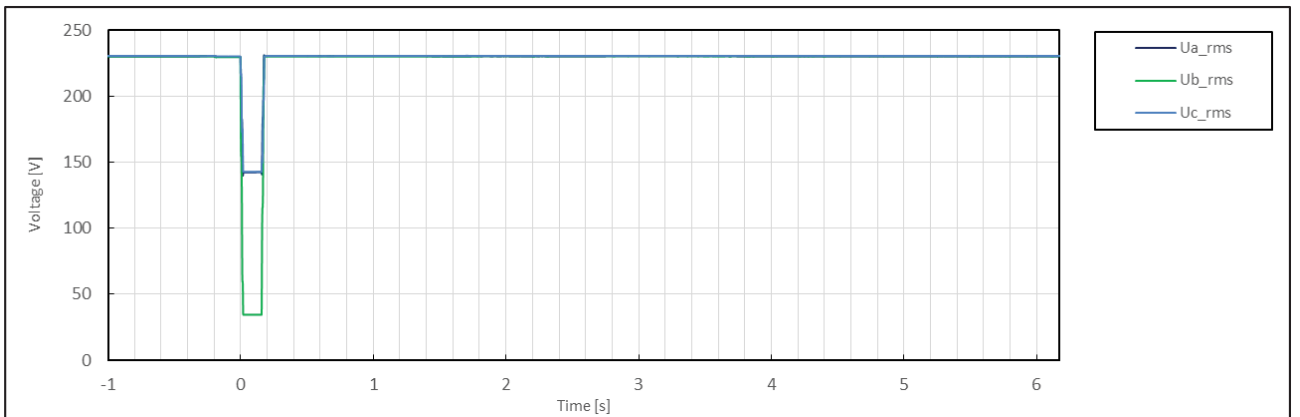
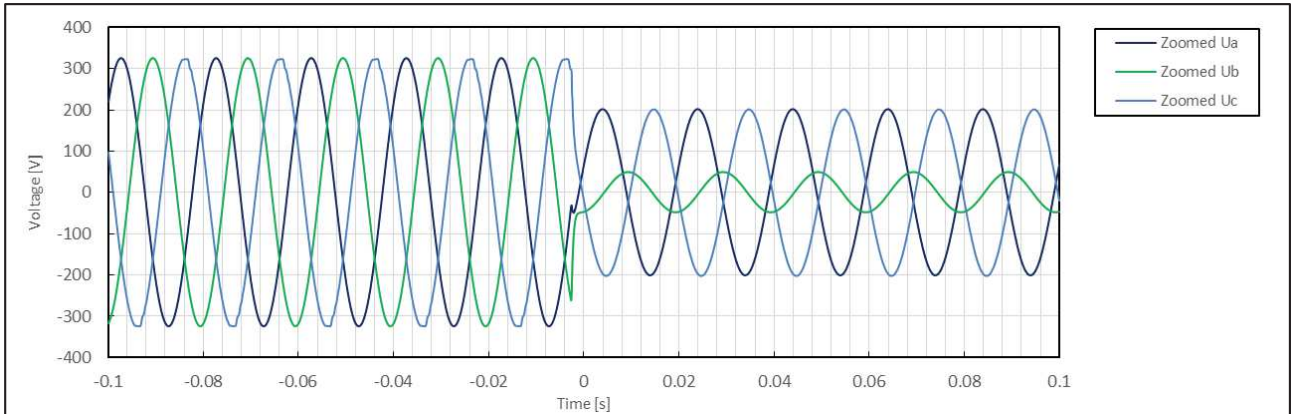
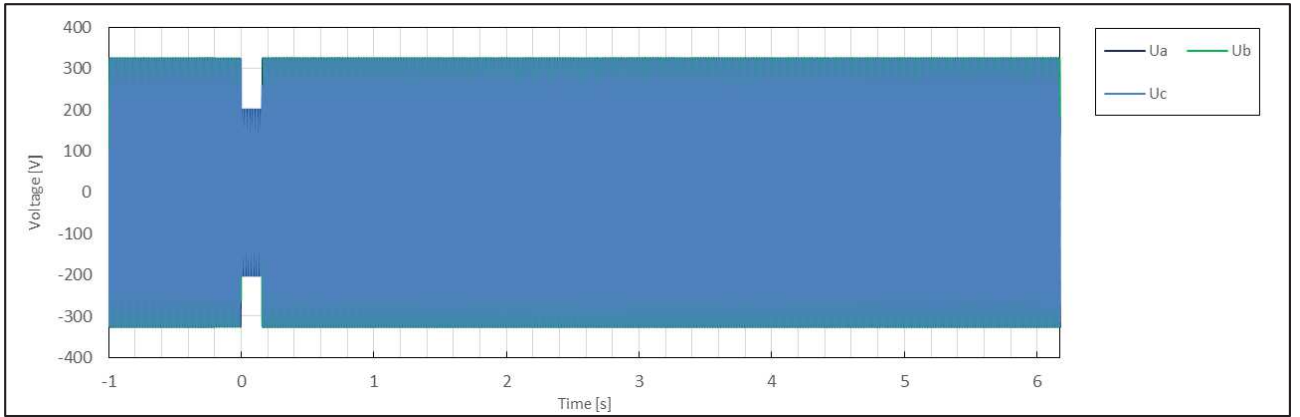

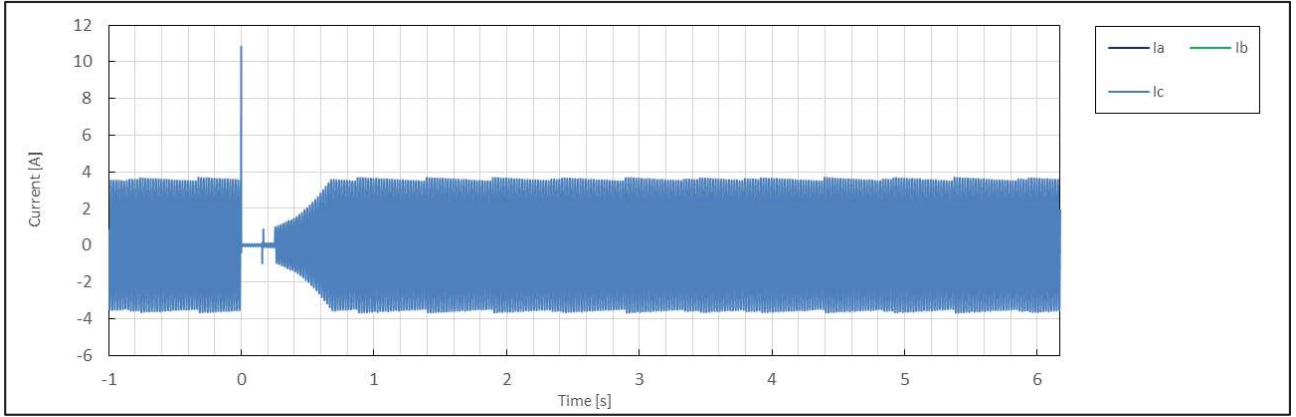
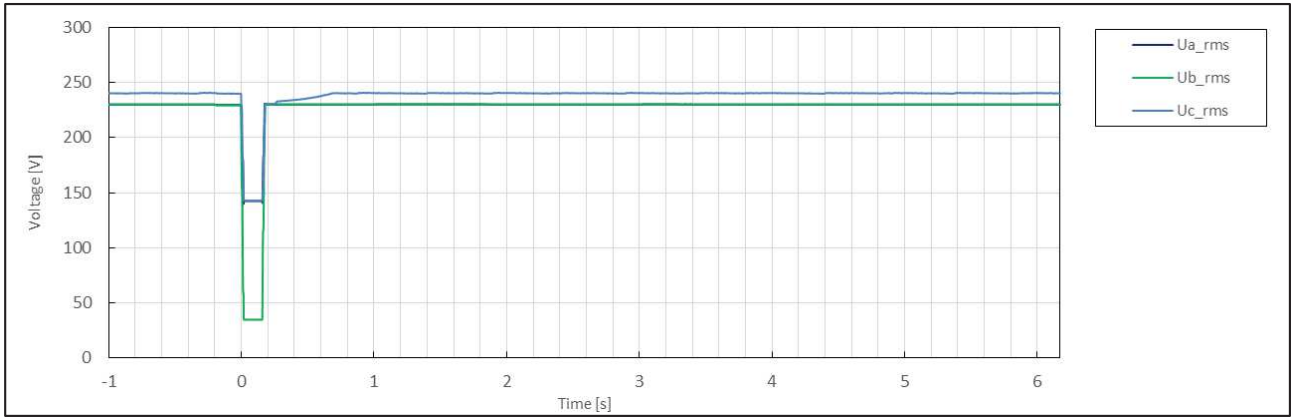
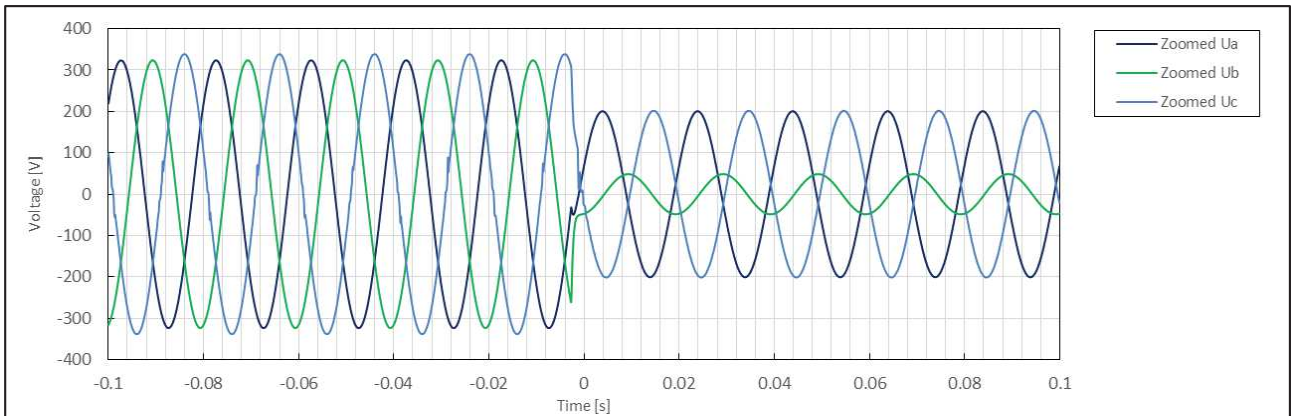
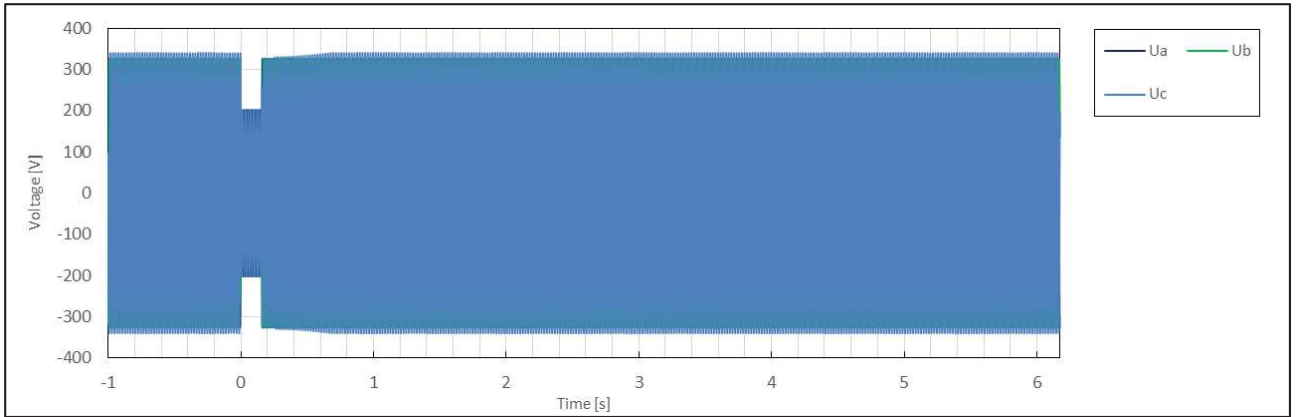

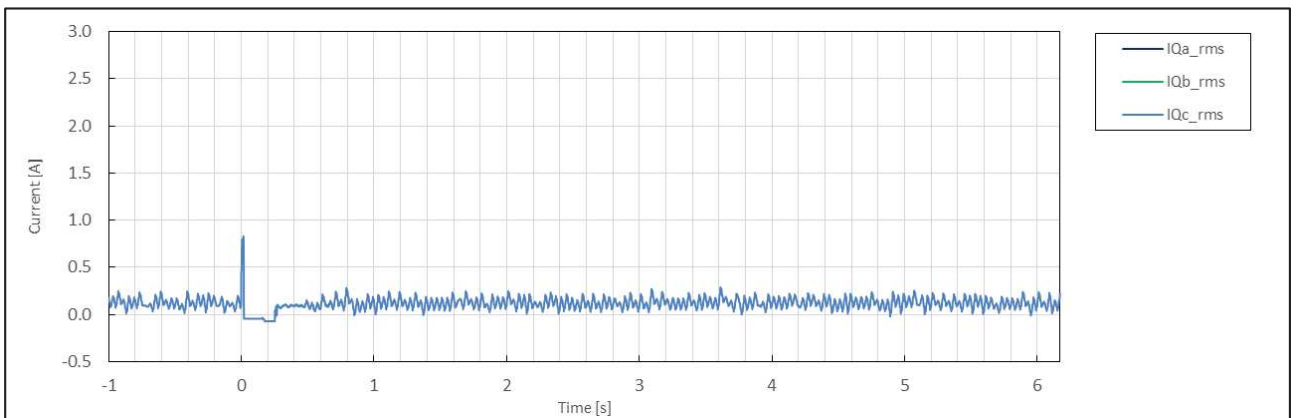
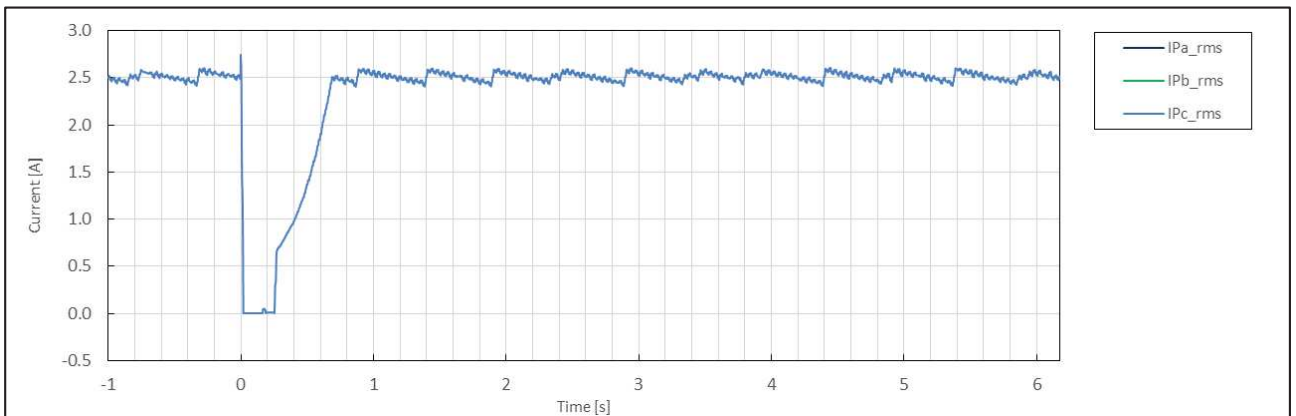
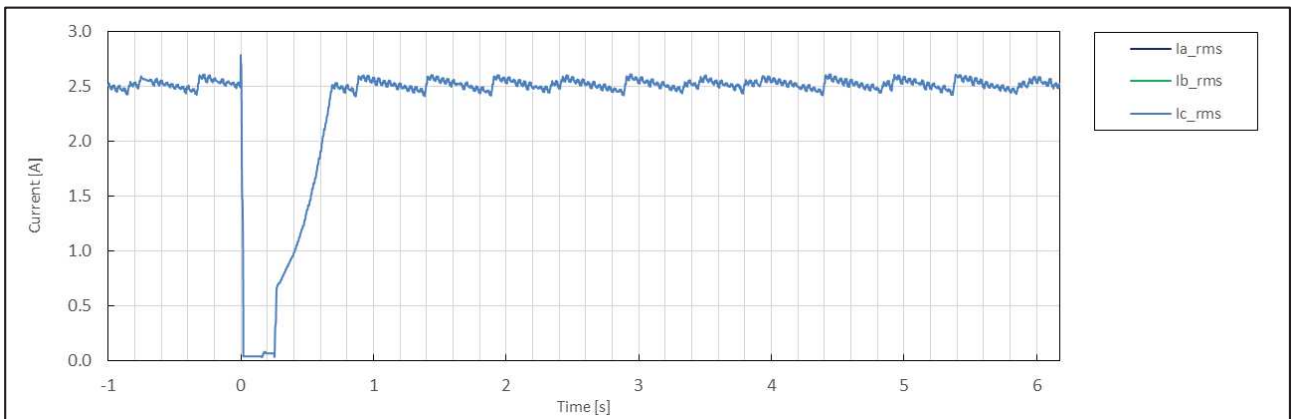
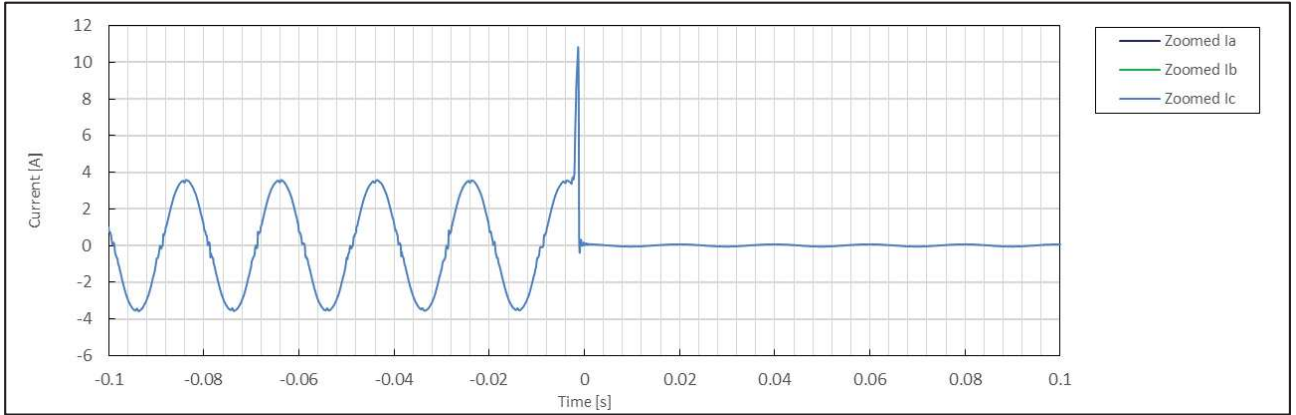

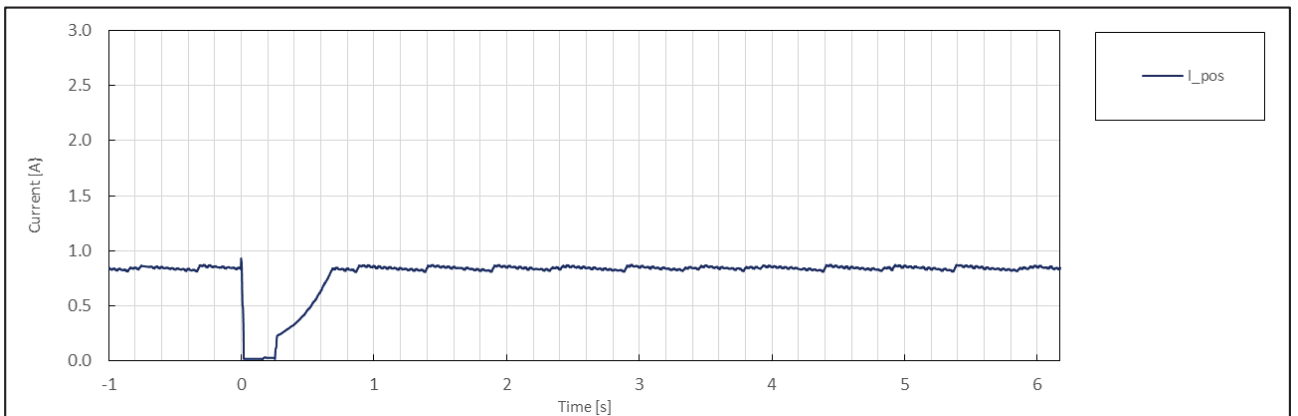
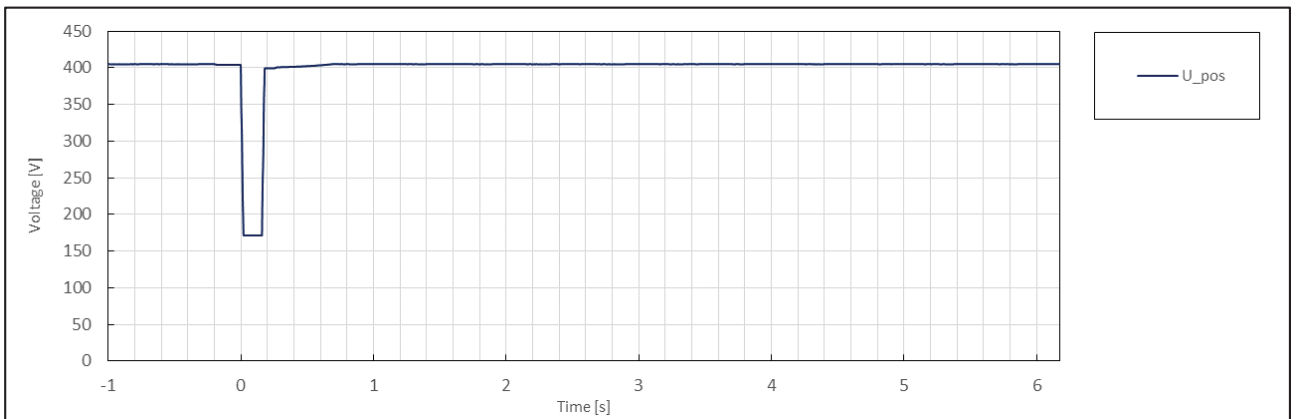
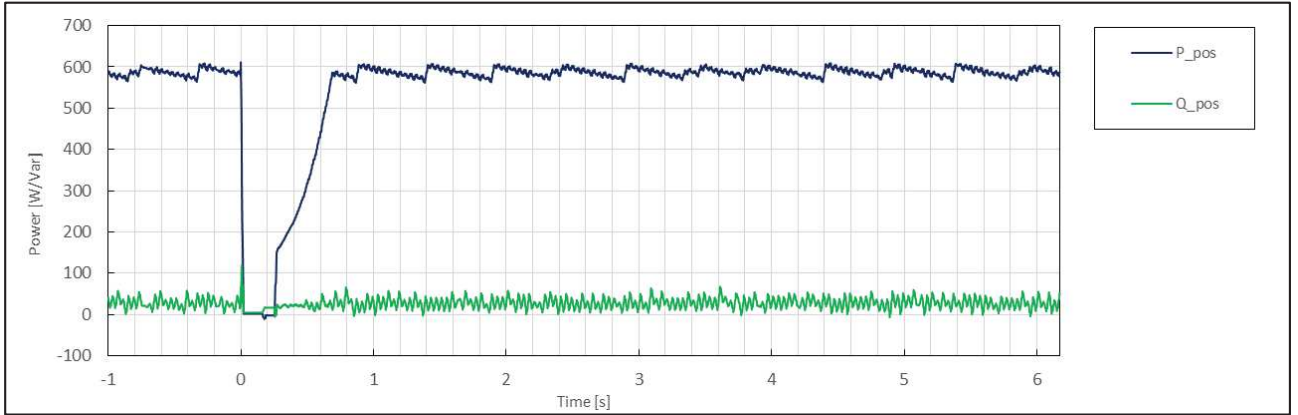

|                     | No. | Parameter  | Phase ref.      | Time ref.                       | unit       | Result        |
|---------------------|-----|--|-----------------|---------------------------------|------------|---------------|
| General Info.       | 0   | Test number  | --              | --                              | --         | 1.3(2)        |
|                     | 1   | Date   | --              | --                              | dd.mm.yyyy | 3.1.2020      |
|                     | 2   | Time (start of test)                                   | --              | --                              | hh:mm:ss.f | 13:14:56      |
|                     | 3   | Fault type (phase)                                     | --              | --                              |            | 2-phase fault |
|                     | 4   | Setting voltage depth                                  | Line to line    | --                              | p.u.       | 0.15          |
|                     | 5   | Setting dip duration                                   |                 | --                              |            | 173           |
|                     | 6   | Point of fault entry                                   | Total           | --                              | ms         | 0             |
|                     | 7   | Point of fault clearance                               | Total           | --                              | ms         | 172           |
|                     | 8   | Fault duration in empty load test                      | Total           | --                              | ms         | 173           |
|                     | 9   | Voltage depth/height in empty load test                | Total           | t1+100ms to t2 and t1-10s to t1 | p.u.       | 0.15          |
|                     | 10  |  | Pos.            |                                 | p.u.       | 0.43          |
| Before dip <t1      | 11  | Voltage  | Line to neutral | t1-100s to t1                   | p.u.       | 1.02          |
|                     | 12  | Current  | Pos.            | t1-500ms to t1-100ms            | p.u.       | 0.32          |
|                     | 13  | Active power   | Total           | t1-10s to t1                    | p.u.       | 1.00          |
|                     | 14  |  | Pos.            |                                 |            | 0.98          |
|                     | 15  | Reactive power   | Total           | t1-10s to t1                    | p.u.       | 0.05          |
|                     | 16  |  | Pos.            |                                 |            | 0.05          |
|                     | 17  | Cos $\phi$   | --              | t1-10s to t1                    | --         | 0.999         |
| During dip t1 to t2 | 18  | Voltage  | Line to neutral | t1+100ms to t2-20ms             | p.u.       | 0.15          |
|                     | 19  | Line current   | Phase 1         | t1+60ms                         | p.u.       | N/A           |
|                     | 20  |  | Phase 2         |                                 |            | 0.00          |
|                     | 21  |  | Phase 3         |                                 |            | N/A           |
|                     | 22  | Line current   | Phase 1         | t1+100ms                        | p.u.       | N/A           |
|                     | 23  |  | Phase 2         |                                 |            | 0.00          |
|                     | 24  |  | Phase 3         |                                 |            | N/A           |
|                     | 25  | Active power   | Total           | t1+100ms to t2-20ms             | p.u.       | 0.00          |
|                     | 26  |  | Pos.            |                                 |            | 0.00          |
| After dip > t2      | 27  | Voltage  | Line to neutral | t2+3s to t2+10s                 | p.u.       | 1.00          |
|                     | 28  | Active power   | Total           | t2+3s to t2+10s                 | p.u.       | 0.98          |
|                     | 29  |  | Pos.            |                                 |            | 0.98          |
|                     | 39  | Active power rising time                               | Pos.            | --                              | s          | 0.664         |
|                     | 31  | Reactive power   | Total           | t2+3s to t2+10s                 | p.u.       | 0.01          |
|                     | 32  |  | Pos.            |                                 |            | 0.01          |
|                     | 33  | Reactive power rising time                             | Pos.            | --                              | s          | N/A           |
|                     | 34  | PGU does not disconnect from grid till 60s after fault | --              | t2 to t2+60s                    | Yes / No   | No            |



Test No. 1.3(D2) idle test

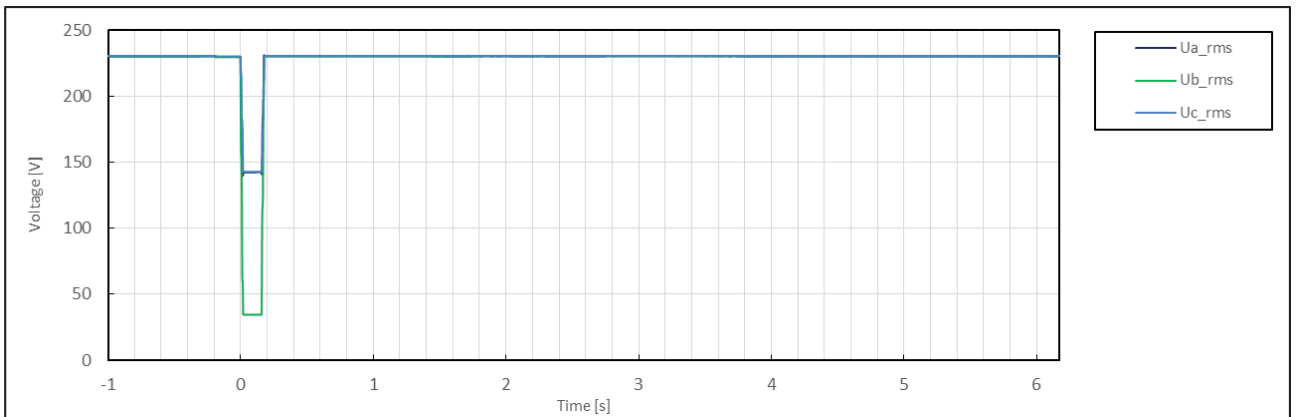
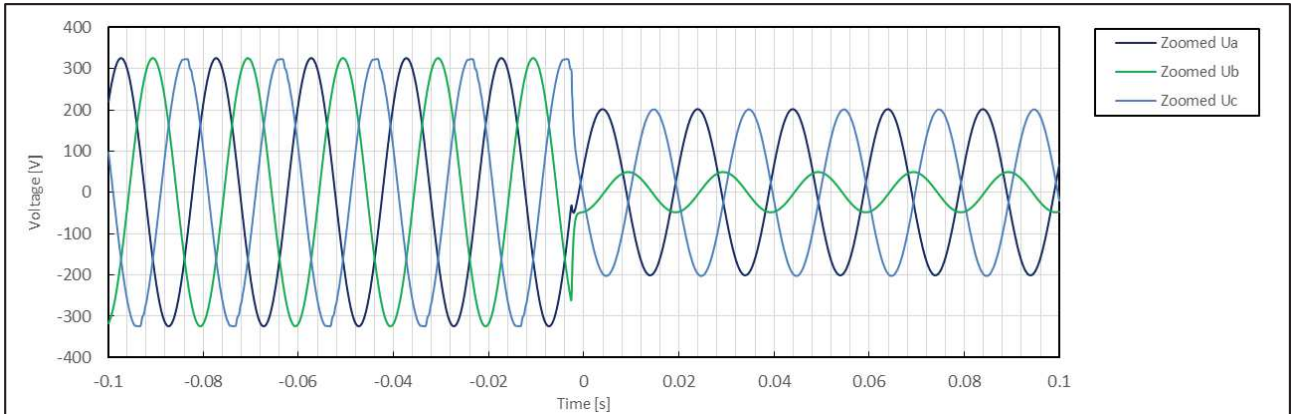
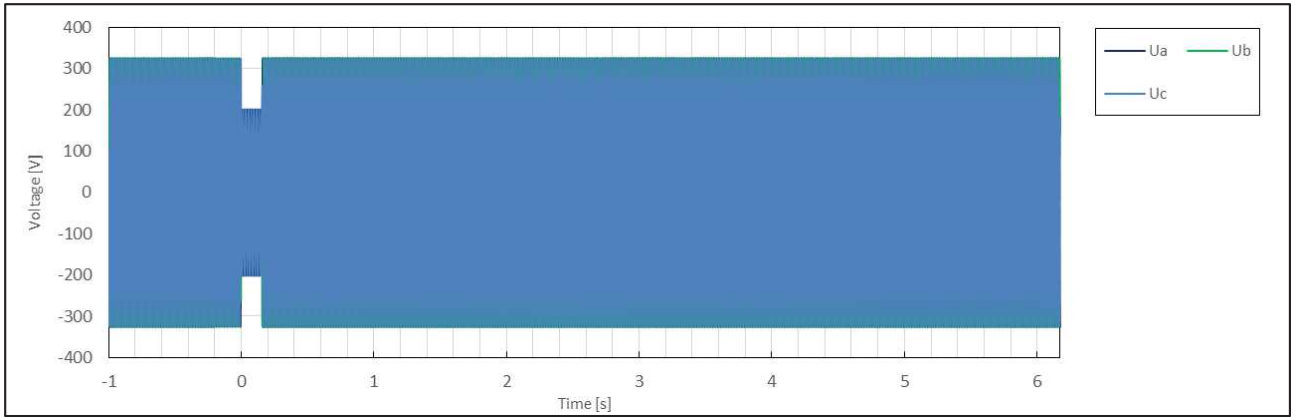

Test No. 1.3(D2) with PGU

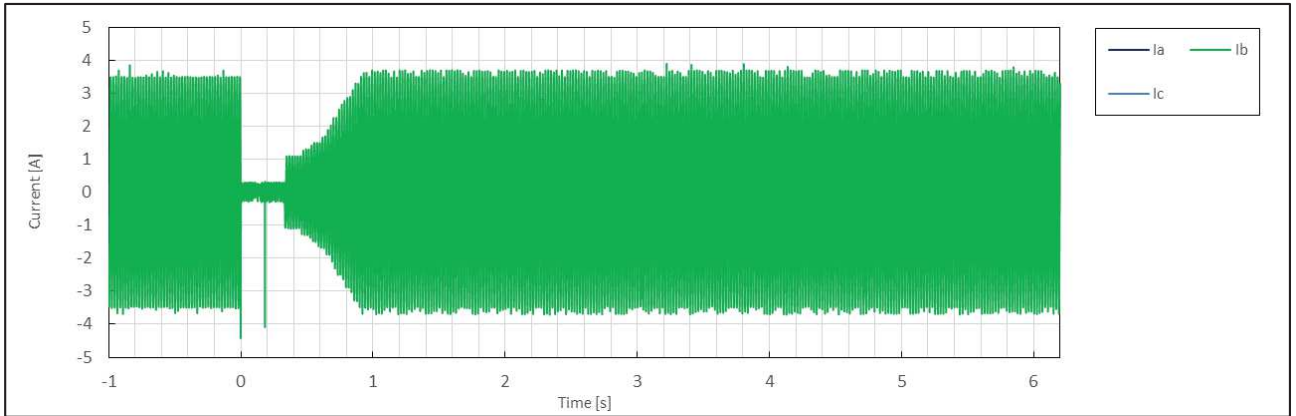
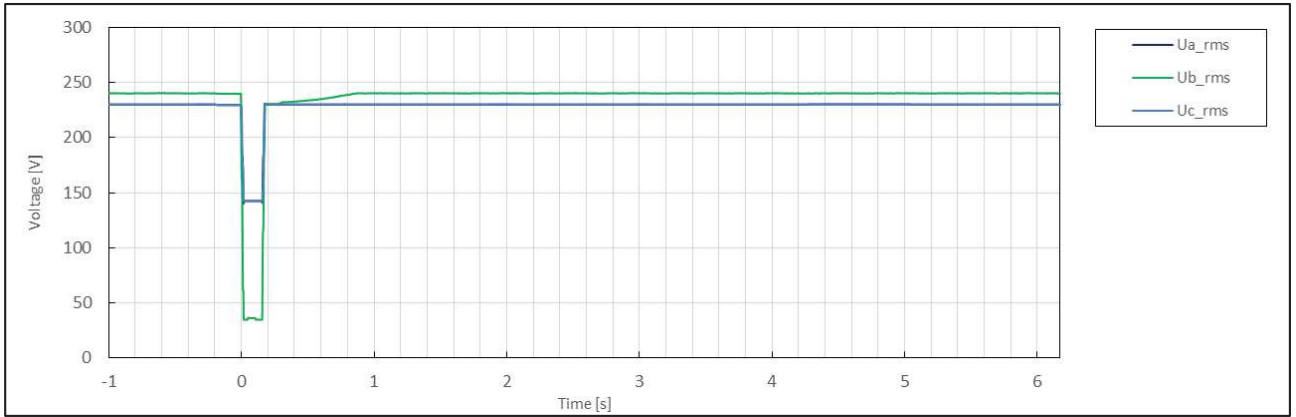
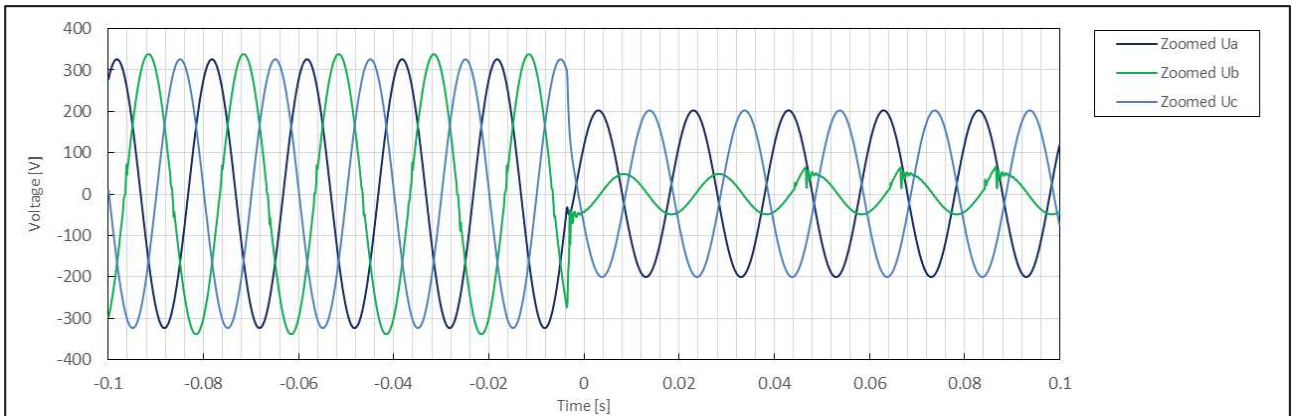
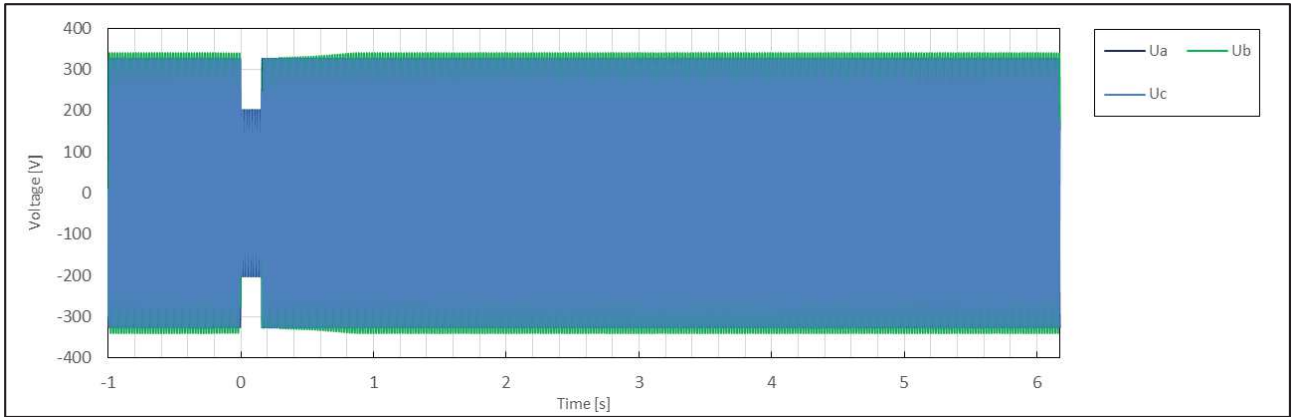

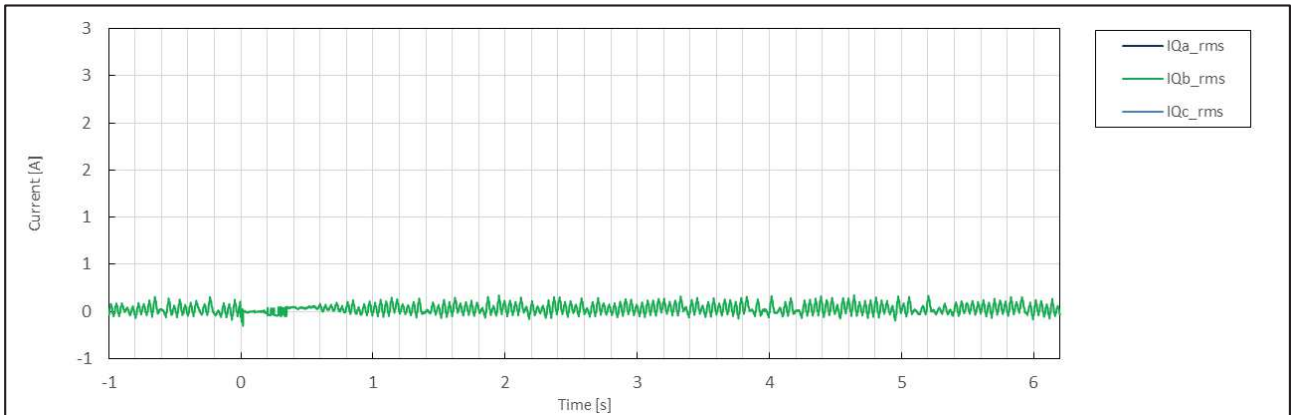
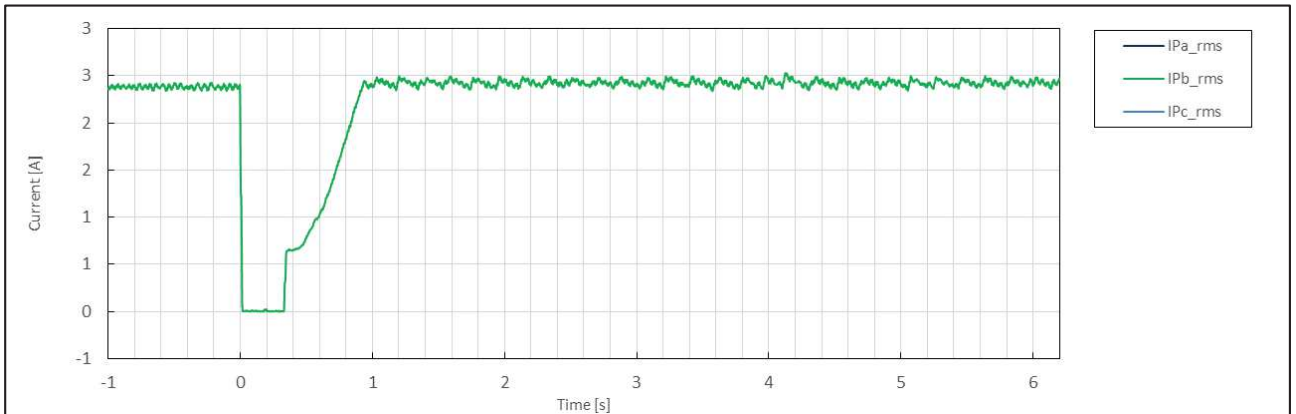
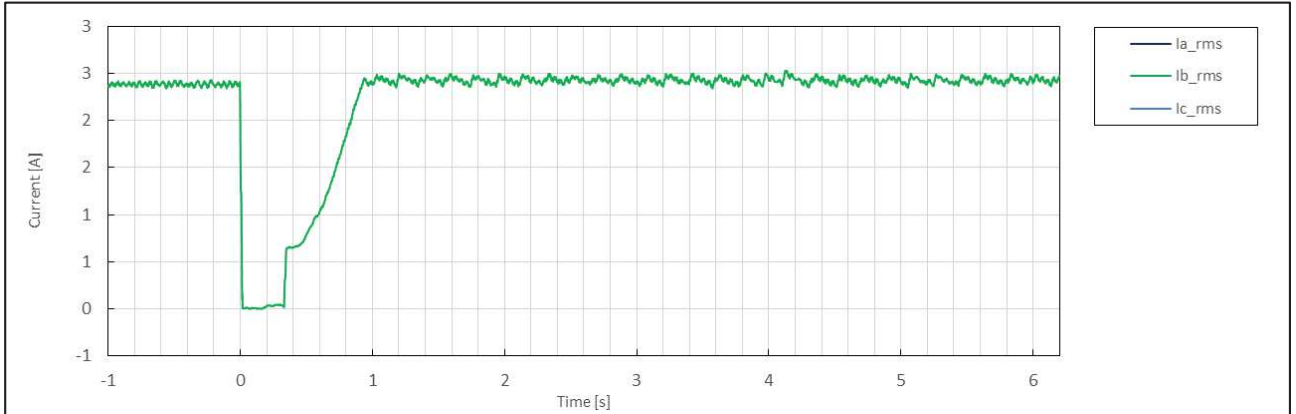
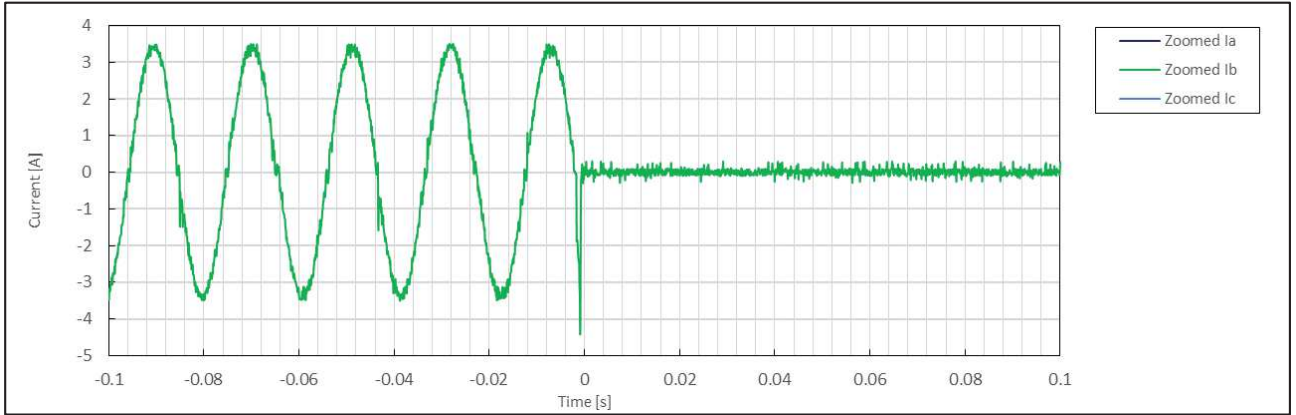

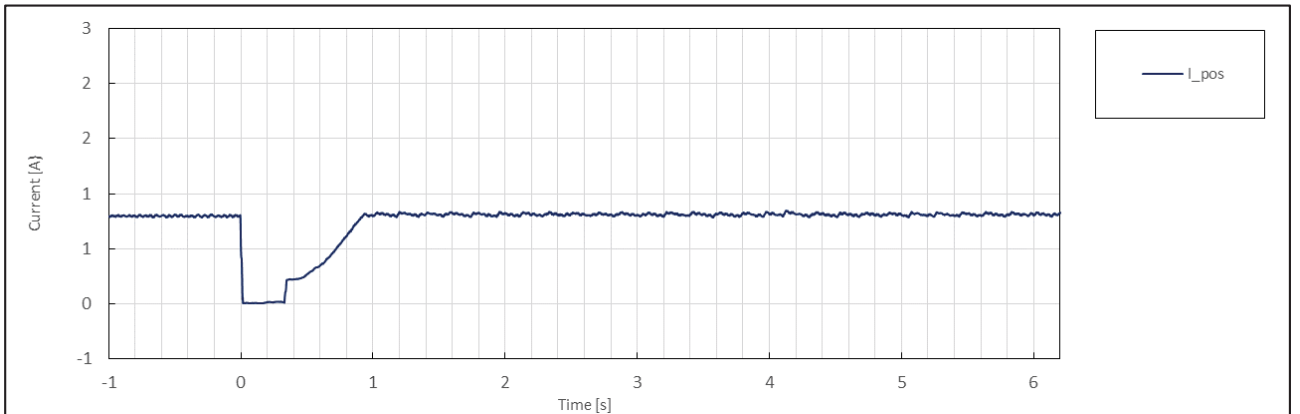
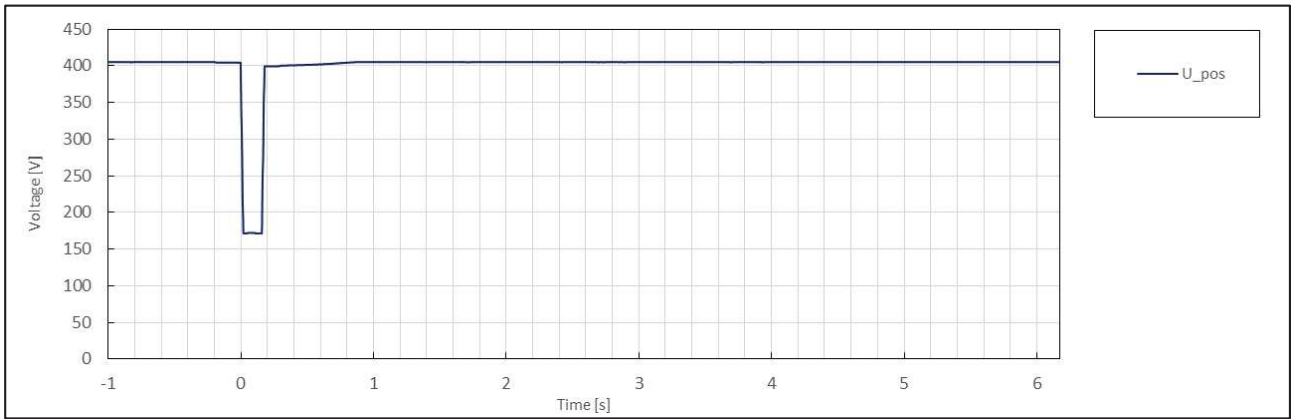
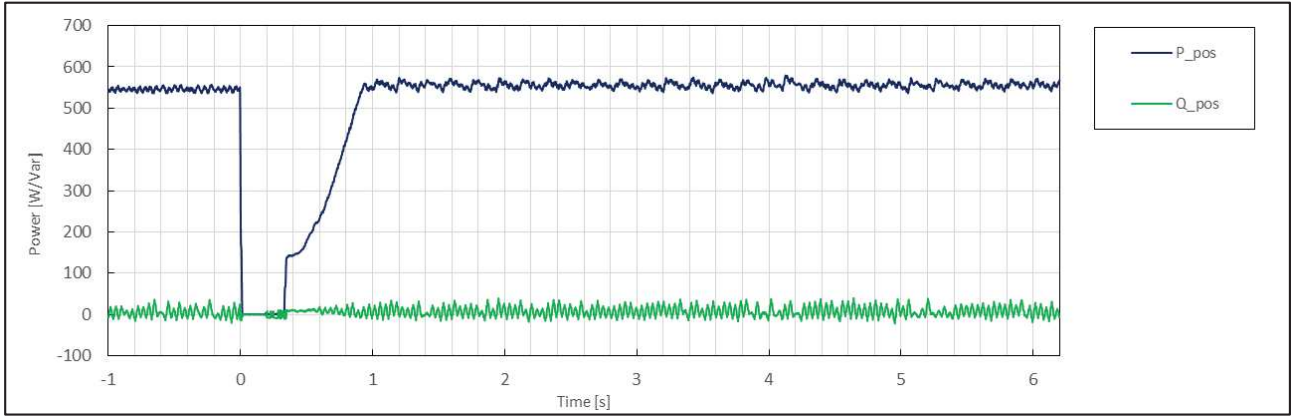

|                     | No. | Parameter  | Phase ref.      | Time ref.                       | unit       | Result        |
|---------------------|-----|--|-----------------|---------------------------------|------------|---------------|
| General Info.       | 0   | Test number  | --              | --                              | --         | 1.4           |
|                     | 1   | Date   | --              | --                              | dd.mm.yyyy | 3.1.2020      |
|                     | 2   | Time (start of test)                                   | --              | --                              | hh:mm:ss.f | 13:18:06      |
|                     | 3   | Fault type (phase)                                     | --              | --                              |            | 2-phase fault |
|                     | 4   | Setting voltage depth                                  | Line to line    | --                              | p.u.       | 0.15          |
|                     | 5   | Setting dip duration                                   |                 | --                              |            | 173           |
|                     | 6   | Point of fault entry                                   | Total           | --                              | ms         | 0             |
|                     | 7   | Point of fault clearance                               | Total           | --                              | ms         | 172           |
|                     | 8   | Fault duration in empty load test                      | Total           | --                              | ms         | 173           |
|                     | 9   | Voltage depth/height in empty load test                | Total           | t1+100ms to t2 and t1-10s to t1 | p.u.       | 0.62          |
|                     | 10  |  | Pos.            |                                 | p.u.       | 0.43          |
| Before dip <t1      | 11  | Voltage  | Line to neutral | t1-100s to t1                   | p.u.       | 1.01          |
|                     | 12  | Current  | Pos.            | t1-500ms to t1-100ms            | p.u.       | 0.11          |
|                     | 13  | Active power   | Total           | t1-10s to t1                    | p.u.       | 0.33          |
|                     | 14  |  | Pos.            |                                 |            | 0.32          |
|                     | 15  | Reactive power   | Total           | t1-10s to t1                    | p.u.       | 0.04          |
|                     | 16  |  | Pos.            |                                 |            | 0.04          |
|                     | 17  | Cos $\phi$   | --              | t1-10s to t1                    | --         | 0.994         |
| During dip t1 to t2 | 18  | Voltage  | Line to neutral | t1+100ms to t2-20ms             | p.u.       | 0.62          |
|                     | 19  | Line current   | Phase 1         | t1+60ms                         | p.u.       | N/A           |
|                     | 20  |  | Phase 2         |                                 |            | N/A           |
|                     | 21  |  | Phase 3         |                                 |            | 0.02          |
|                     | 22  | Line current   | Phase 1         | t1+100ms                        | p.u.       | N/A           |
|                     | 23  |  | Phase 2         |                                 |            | N/A           |
|                     | 24  |  | Phase 3         |                                 |            | 0.02          |
|                     | 25  | Active power   | Total           | t1+100ms to t2-20ms             | p.u.       | 0.00          |
|                     | 26  |  | Pos.            |                                 |            | 0.00          |
| After dip > t2      | 27  | Voltage  | Line to neutral | t2+3s to t2+10s                 | p.u.       | 1.01          |
|                     | 28  | Active power   | Total           | t2+3s to t2+10s                 | p.u.       | 0.33          |
|                     | 29  |  | Pos.            |                                 |            | 0.33          |
|                     | 39  | Active power rising time                               | Pos.            | --                              | s          | 0.194         |
|                     | 31  | Reactive power   | Total           | t2+3s to t2+10s                 | p.u.       | 0.04          |
|                     | 32  |  | Pos.            |                                 |            | 0.04          |
|                     | 33  | Reactive power rising time                             | Pos.            | --                              | s          | N/A           |
|                     | 34  | PGU does not disconnect from grid till 60s after fault | --              | t2 to t2+60s                    | Yes / No   | No            |

Test No. 1.4 idle test

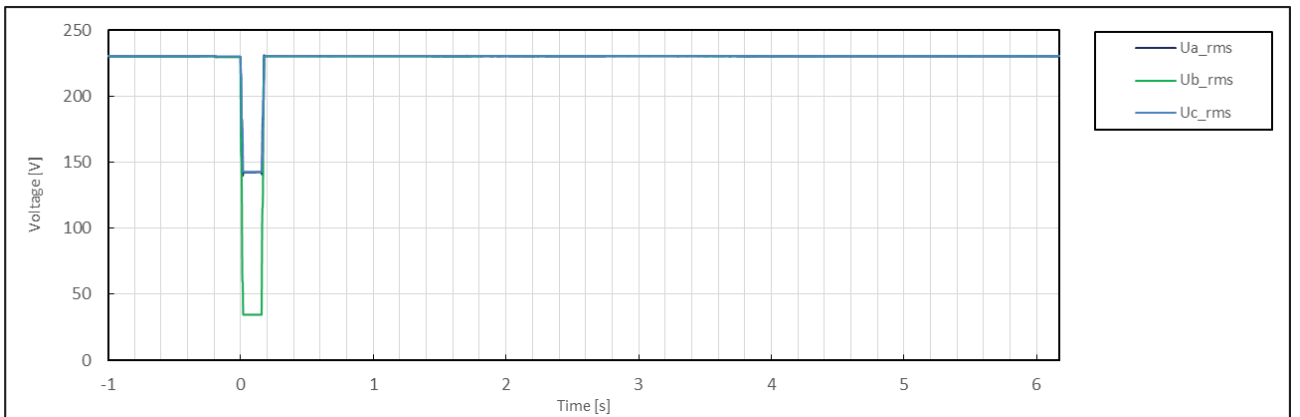
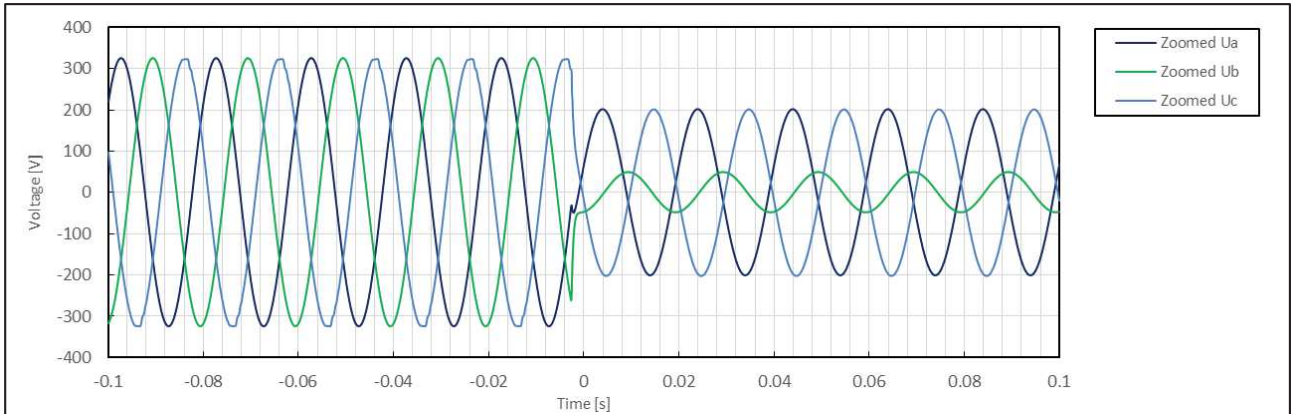
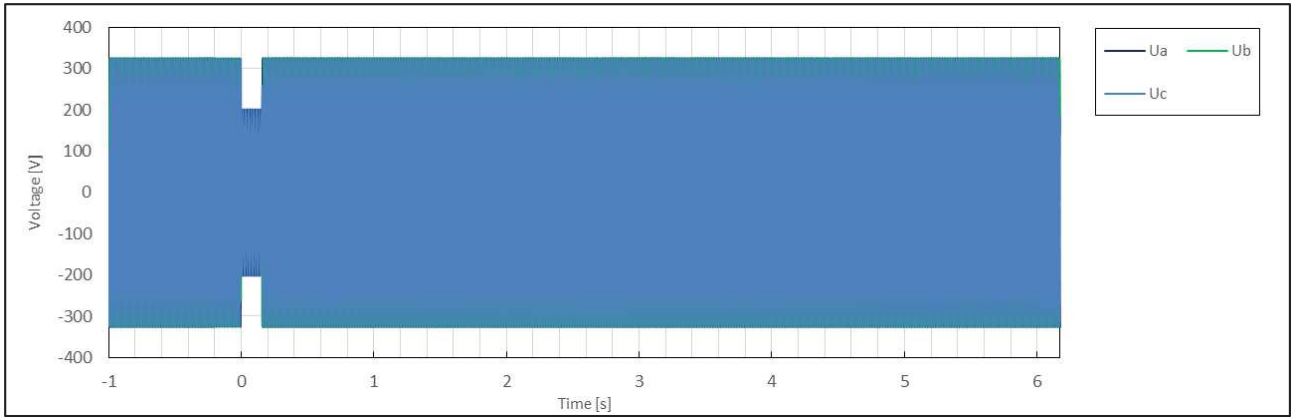

Test No. 1.4 with PGU

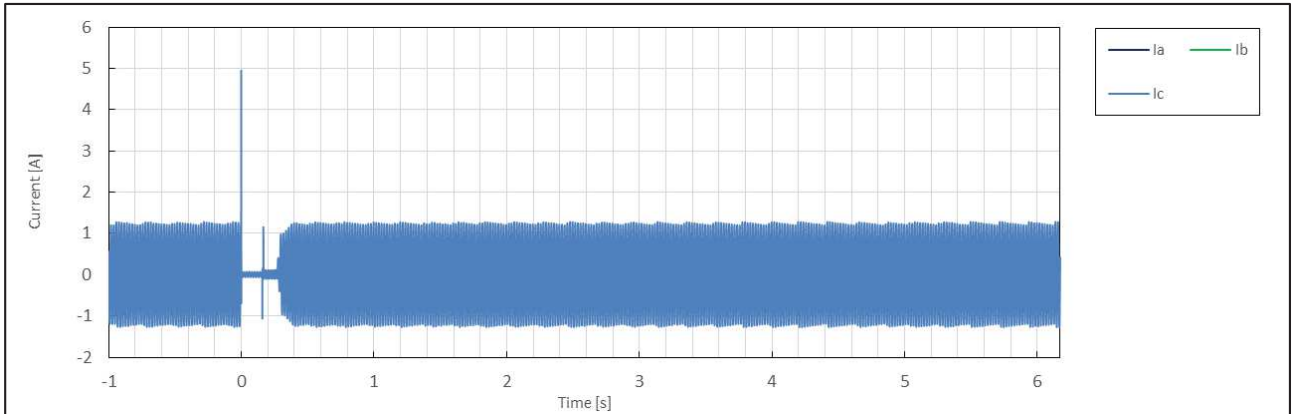
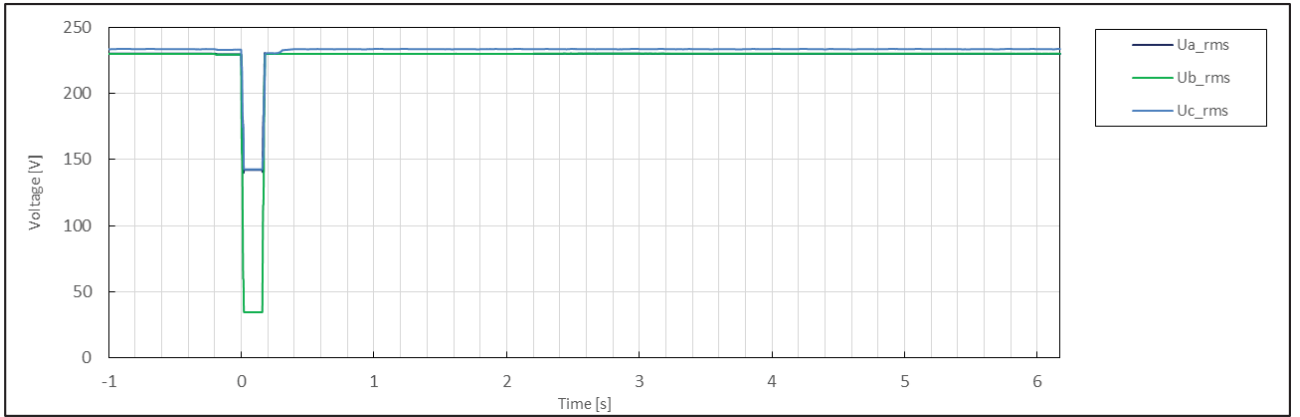
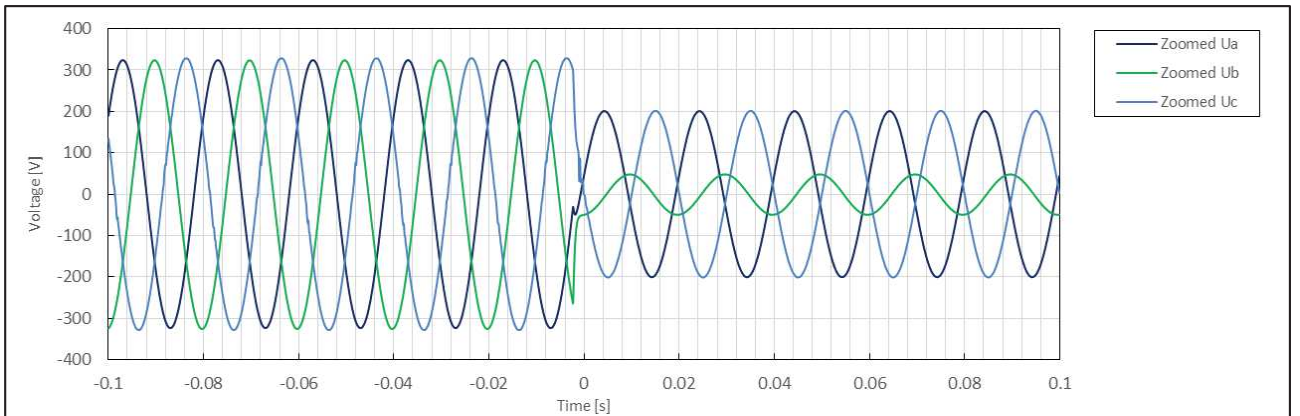
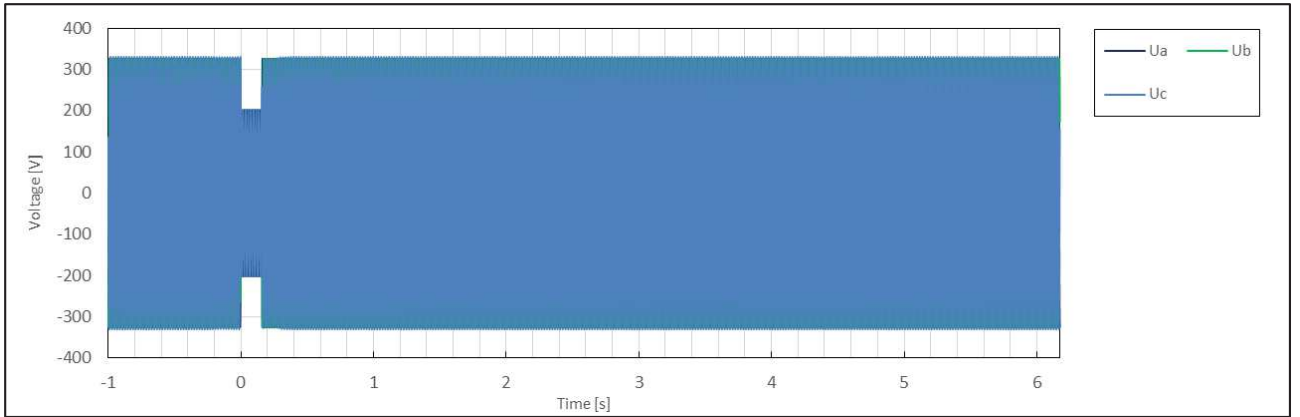



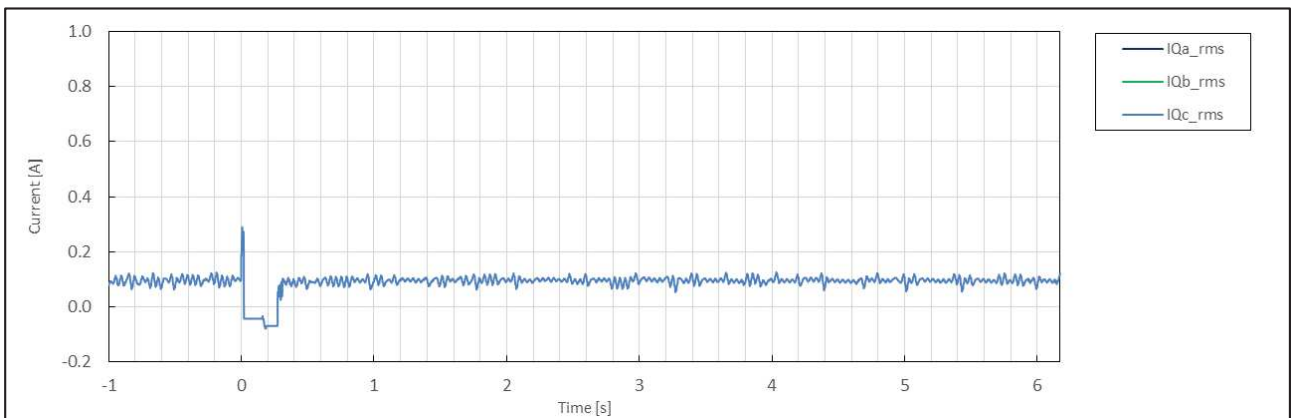
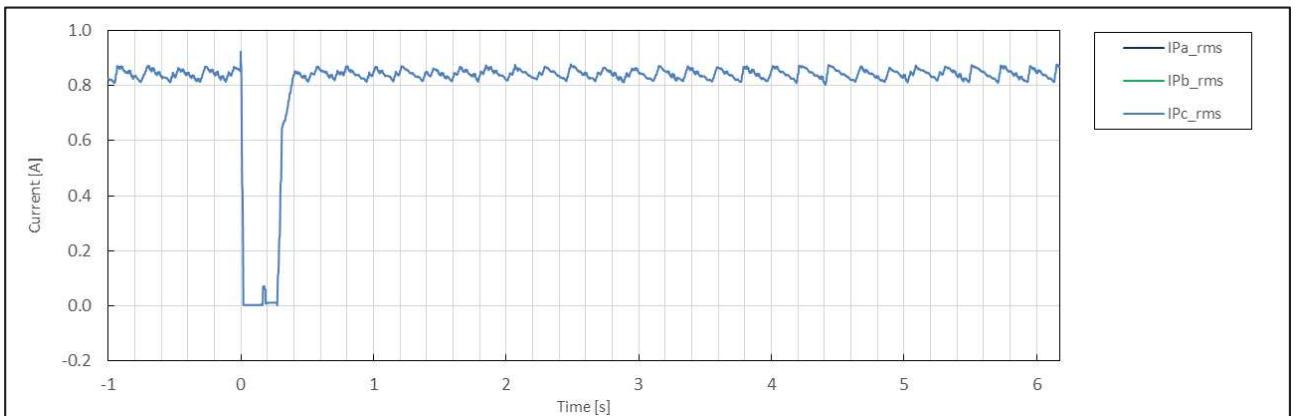
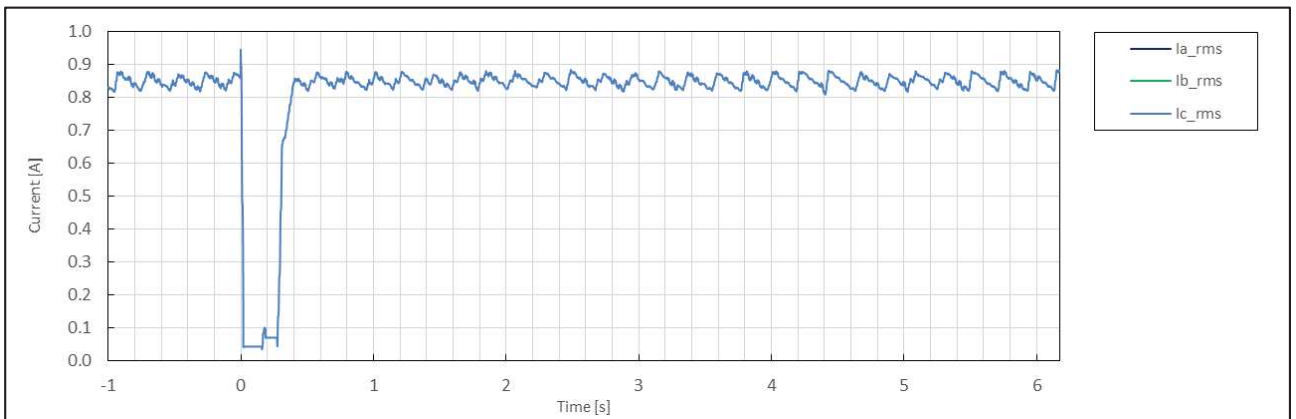
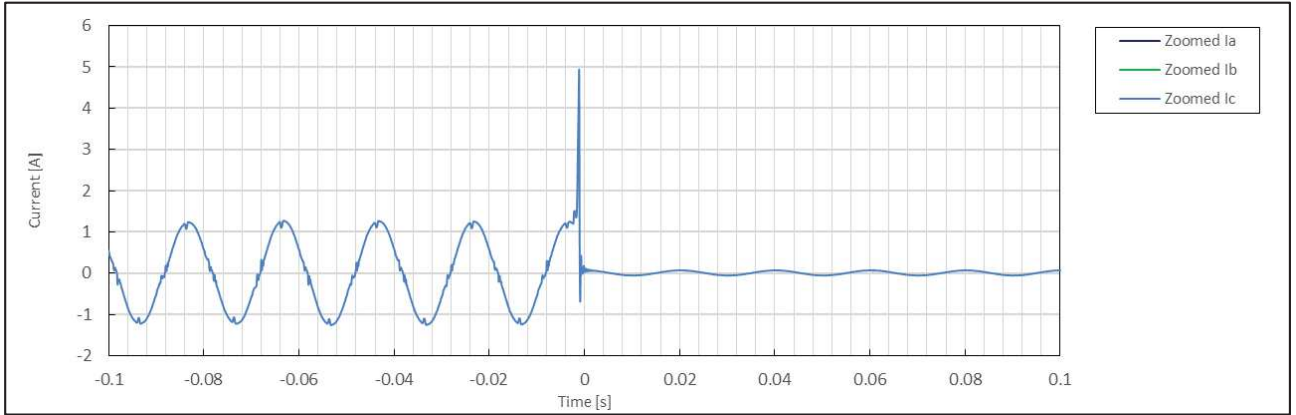



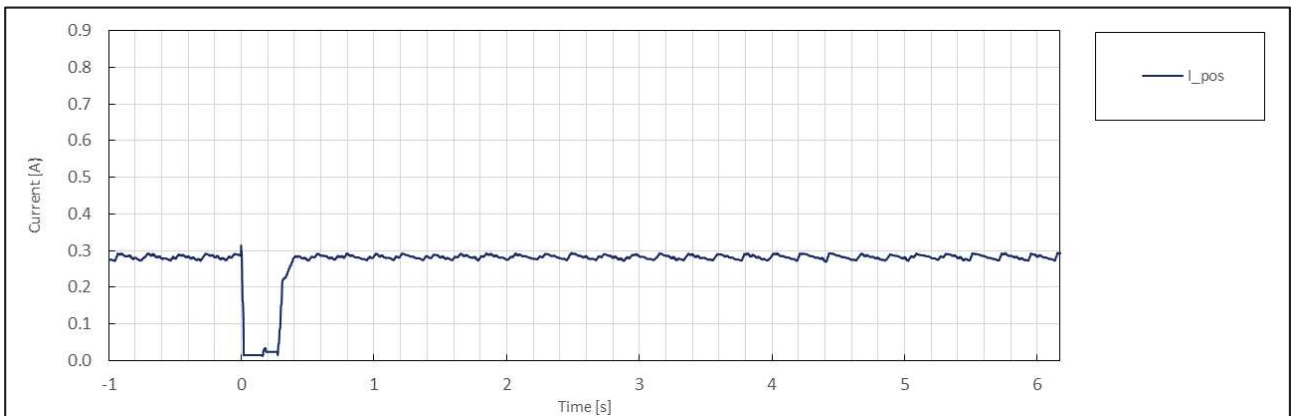
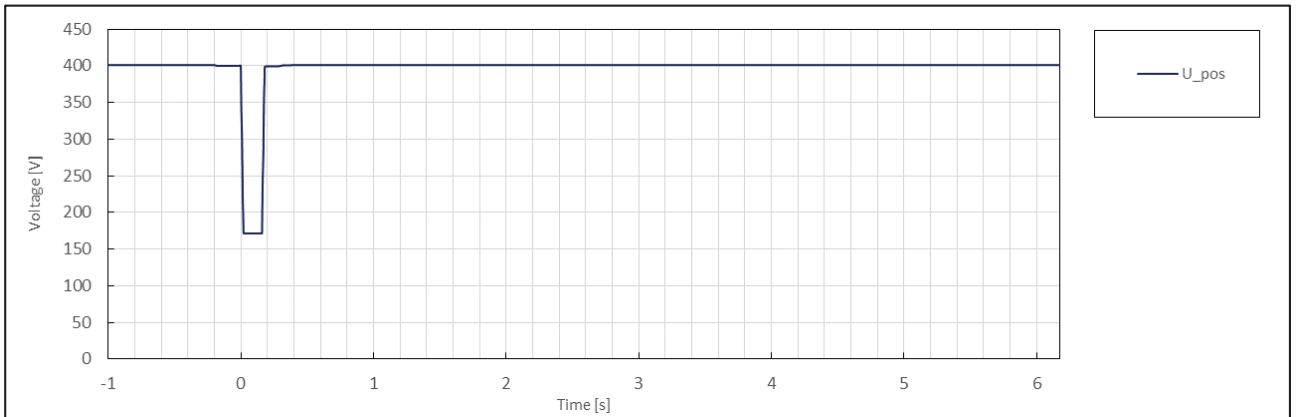
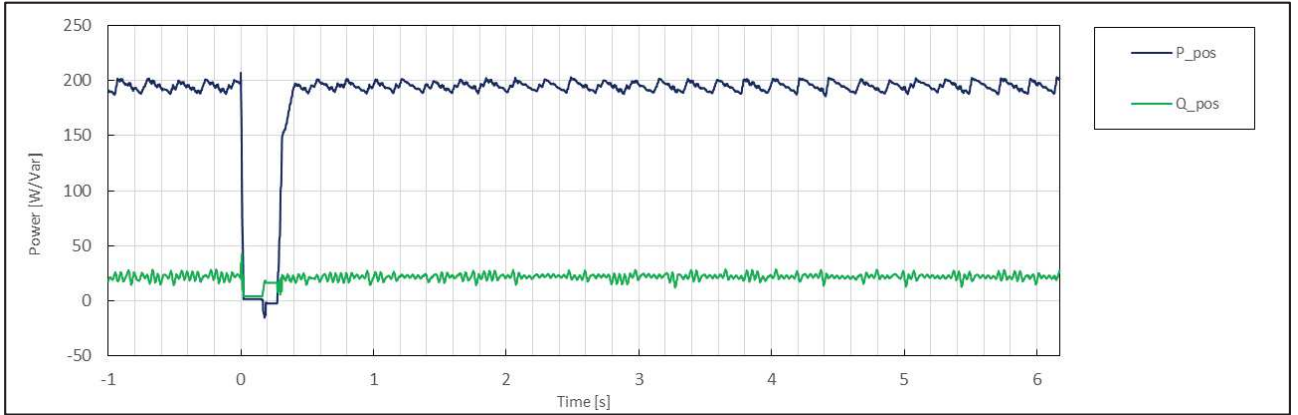

|                     | No. | Parameter  | Phase ref.      | Time ref.                       | unit       | Result        |
|---------------------|-----|--|-----------------|---------------------------------|------------|---------------|
| General Info.       | 0   | Test number  | --              | --                              | --         | 1.4(2)        |
|                     | 1   | Date   | --              | --                              | dd.mm.yyyy | 3.1.2020      |
|                     | 2   | Time (start of test)                                   | --              | --                              | hh:mm:ss.f | 13:24:15      |
|                     | 3   | Fault type (phase)                                     | --              | --                              |            | 2-phase fault |
|                     | 4   | Setting voltage depth                                  | Line to line    | --                              | p.u.       | 0.15          |
|                     | 5   | Setting dip duration                                   |                 | --                              |            | 173           |
|                     | 6   | Point of fault entry                                   | Total           | --                              | ms         | 0             |
|                     | 7   | Point of fault clearance                               | Total           | --                              | ms         | 172           |
|                     | 8   | Fault duration in empty load test                      | Total           | --                              | ms         | 173           |
|                     | 9   | Voltage depth/height in empty load test                | Total           | t1+100ms to t2 and t1-10s to t1 | p.u.       | 0.15          |
|                     | 10  |  | Pos.            |                                 | p.u.       | 0.43          |
| Before dip <t1      | 11  | Voltage  | Line to neutral | t1-100s to t1                   | p.u.       | 1.01          |
|                     | 12  | Current  | Pos.            | t1-500ms to t1-100ms            | p.u.       | 0.16          |
|                     | 13  | Active power   | Total           | t1-10s to t1                    | p.u.       | 0.49          |
|                     | 14  |  | Pos.            |                                 |            | 0.48          |
|                     | 15  | Reactive power   | Total           | t1-10s to t1                    | p.u.       | 0.04          |
|                     | 16  |  | Pos.            |                                 |            | 0.04          |
|                     | 17  | Cos $\varphi$  | --              | t1-10s to t1                    | --         | 0.997         |
| During dip t1 to t2 | 18  | Voltage  | Line to neutral | t1+100ms to t2-20ms             | p.u.       | 0.15          |
|                     | 19  | Line current   | Phase 1         | t1+60ms                         | p.u.       | N/A           |
|                     | 20  |  | Phase 2         |                                 |            | 0.00          |
|                     | 21  |  | Phase 3         |                                 |            | N/A           |
|                     | 22  | Line current   | Phase 1         | t1+100ms                        | p.u.       | N/A           |
|                     | 23  |  | Phase 2         |                                 |            | 0.00          |
|                     | 24  |  | Phase 3         |                                 |            | N/A           |
|                     | 25  | Active power   | Total           | t1+100ms to t2-20ms             | p.u.       | 0.00          |
|                     | 26  |  | Pos.            |                                 |            | 0.00          |
| After dip > t2      | 27  | Voltage  | Line to neutral | t2+3s to t2+10s                 | p.u.       | 1.00          |
|                     | 28  | Active power   | Total           | t2+3s to t2+10s                 | p.u.       | 0.48          |
|                     | 29  |  | Pos.            |                                 |            | 0.48          |
|                     | 39  | Active power rising time                               | Pos.            | --                              | s          | 0.853         |
|                     | 31  | Reactive power   | Total           | t2+3s to t2+10s                 | p.u.       | 0.01          |
|                     | 32  |  | Pos.            |                                 |            | 0.01          |
|                     | 33  | Reactive power rising time                             | Pos.            | --                              | s          | N/A           |
|                     | 34  | PGU does not disconnect from grid till 60s after fault | --              | t2 to t2+60s                    | Yes / No   | No            |

Test No. 1.4(D2) idle test

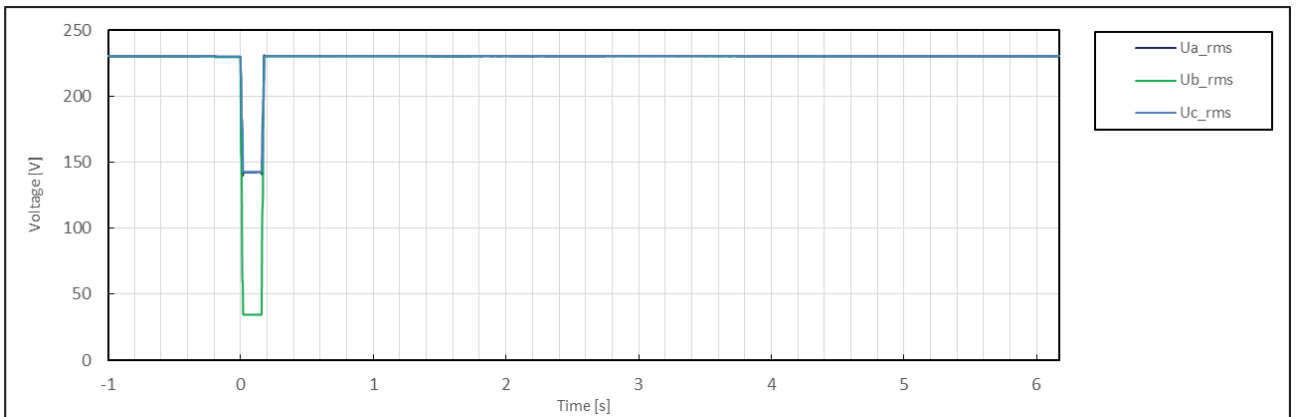
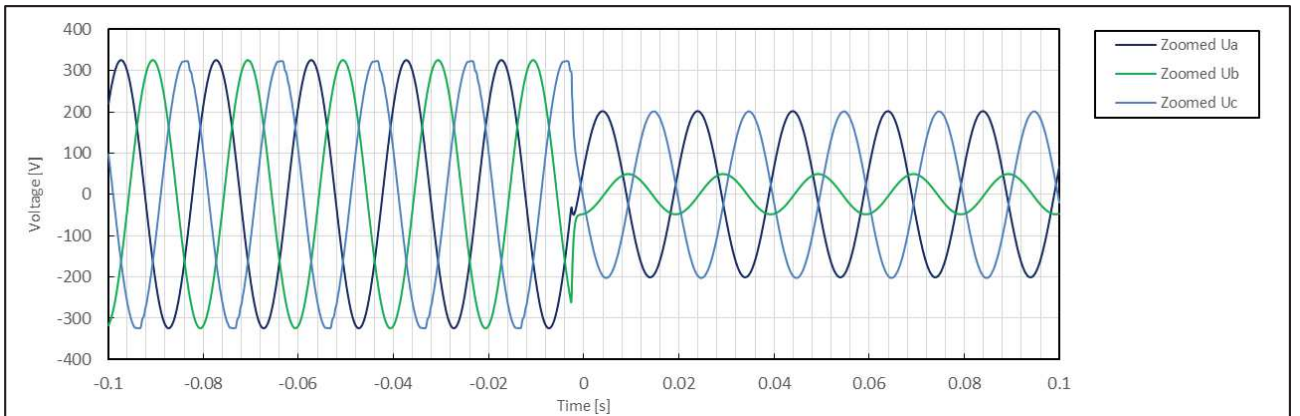
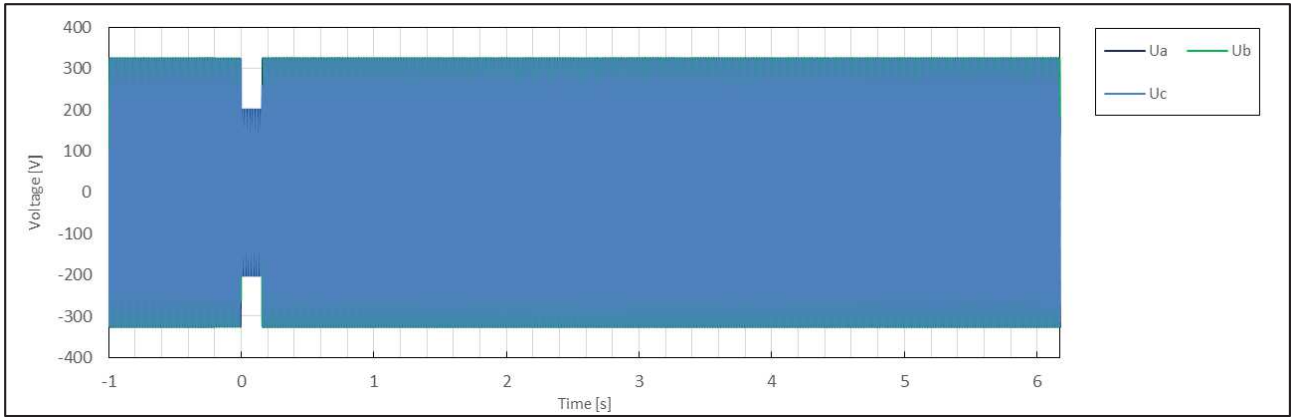

Test No. 1.4(D2) with PGU

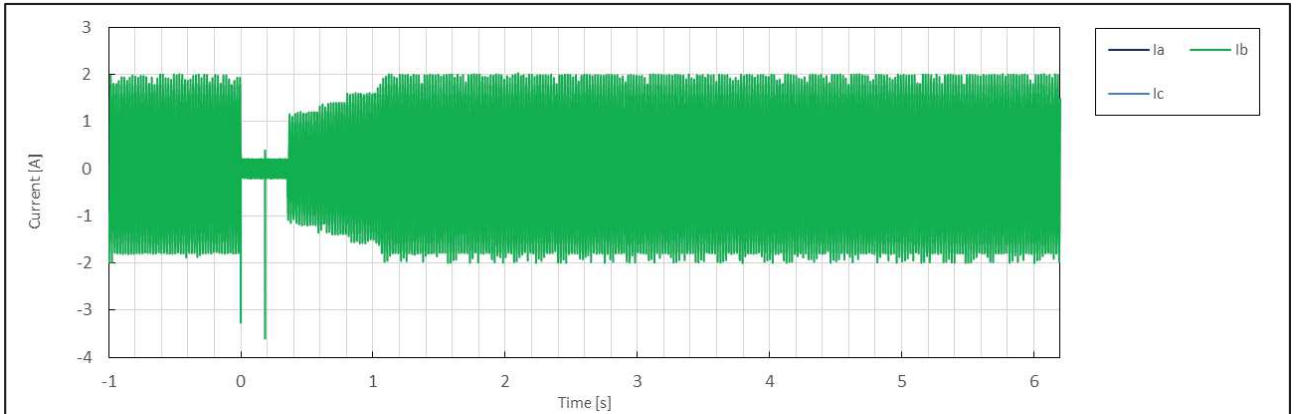
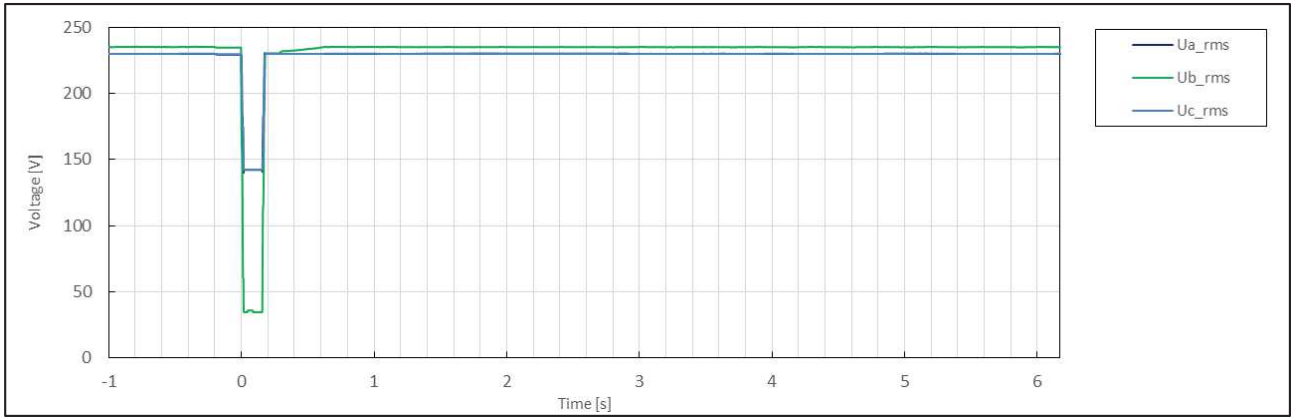
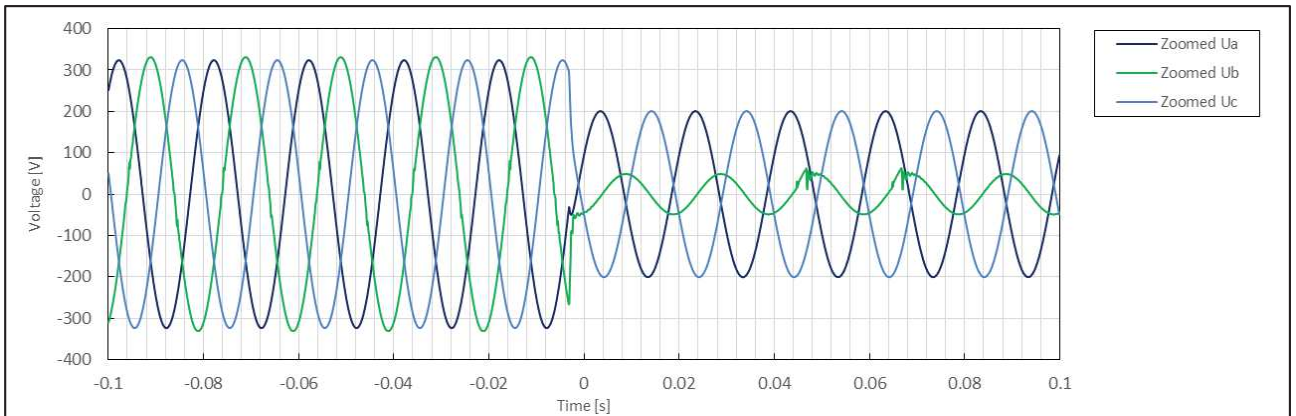
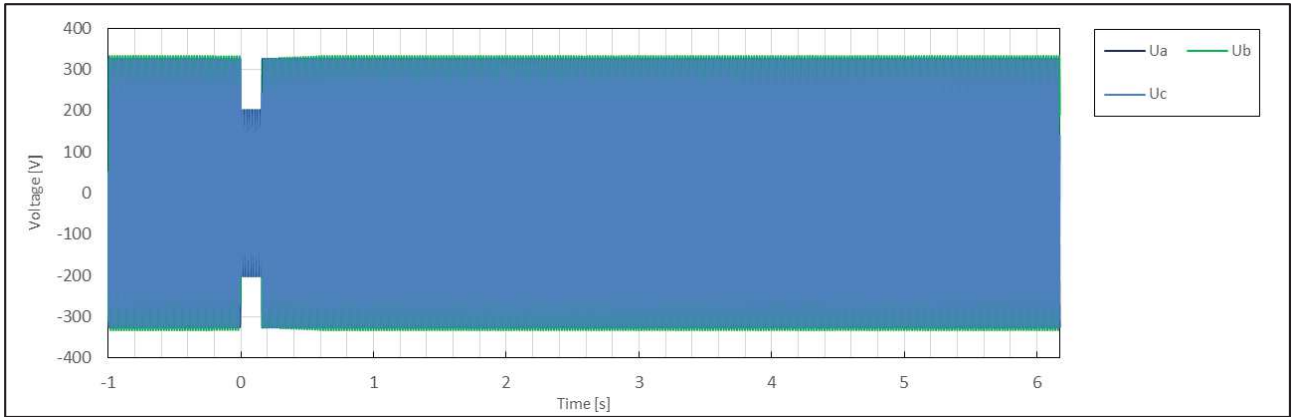

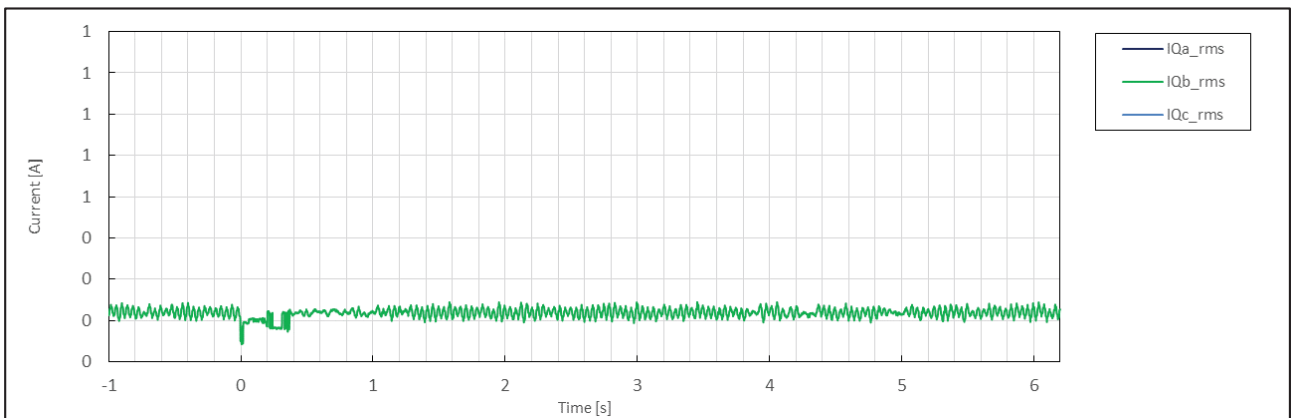
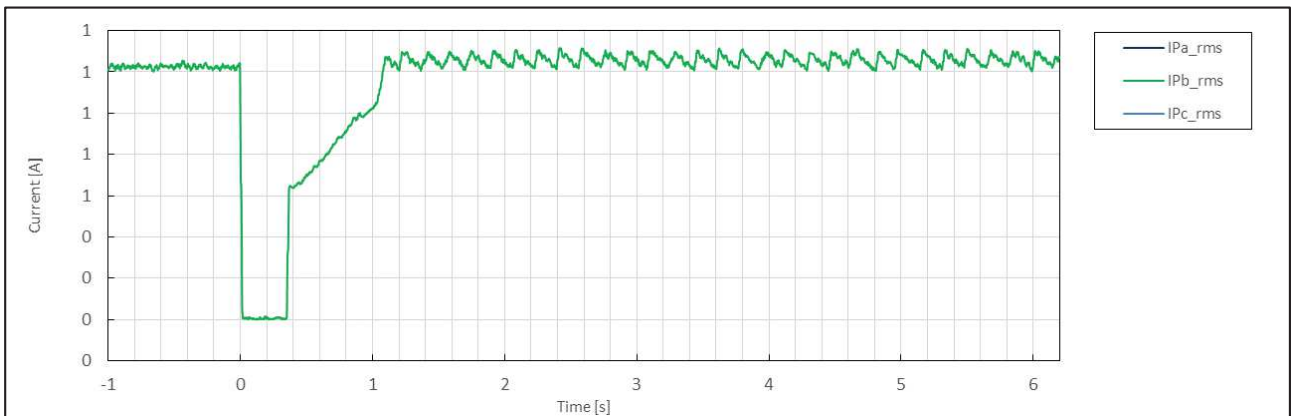
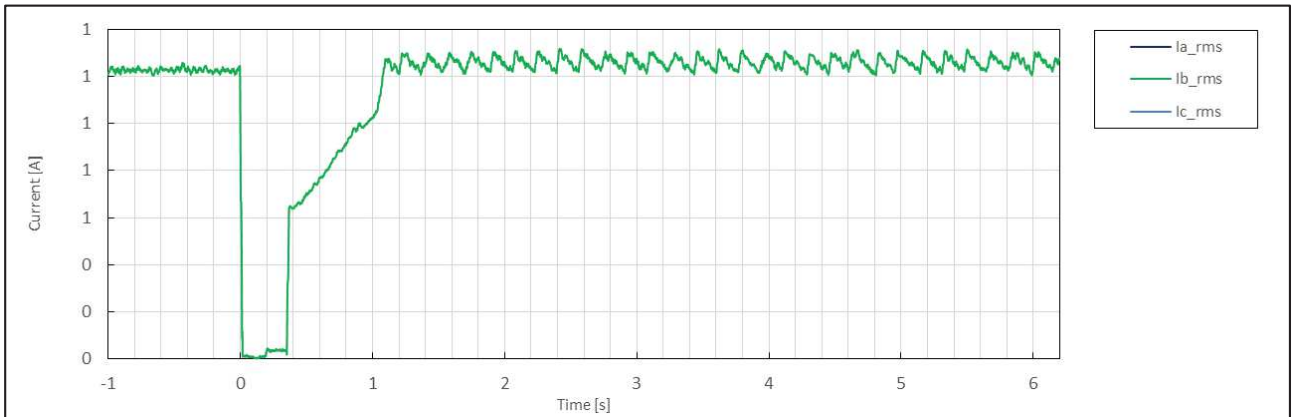
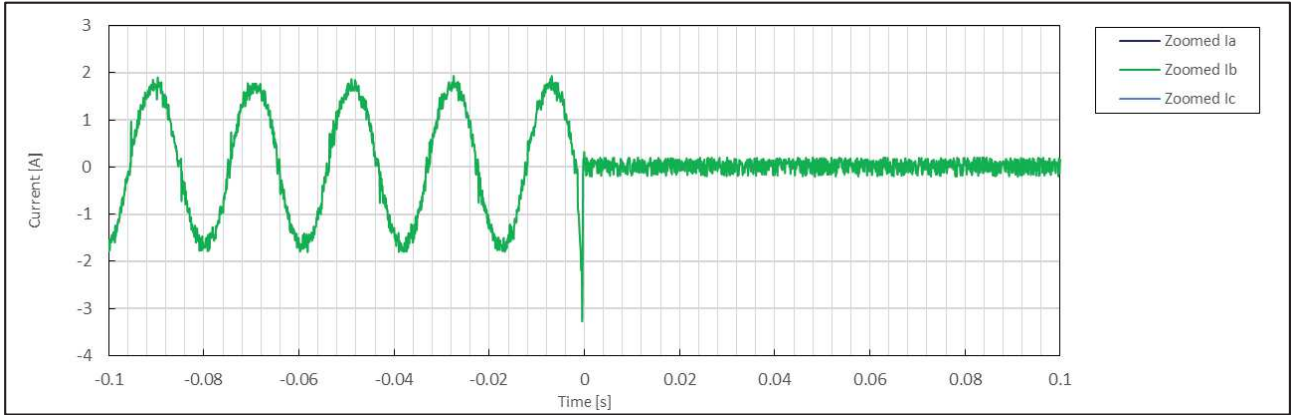

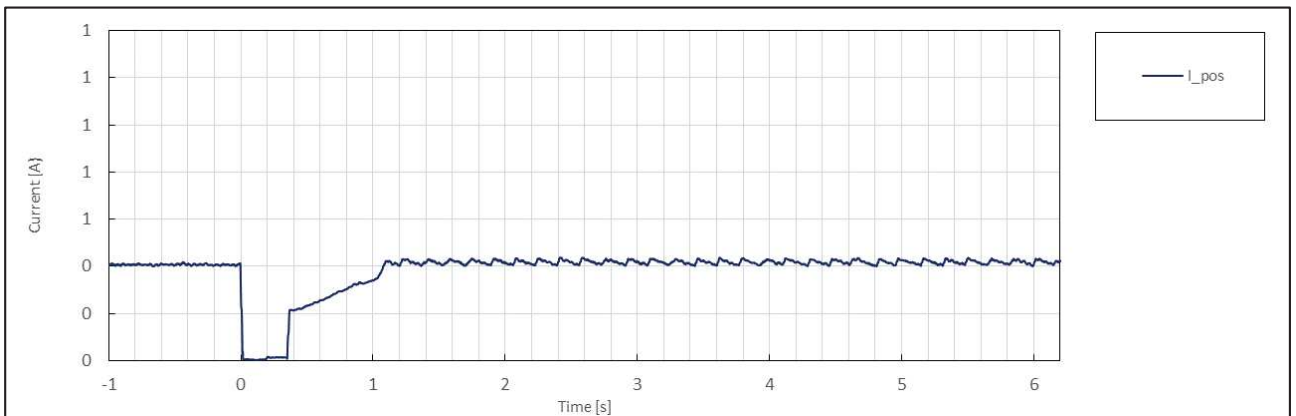
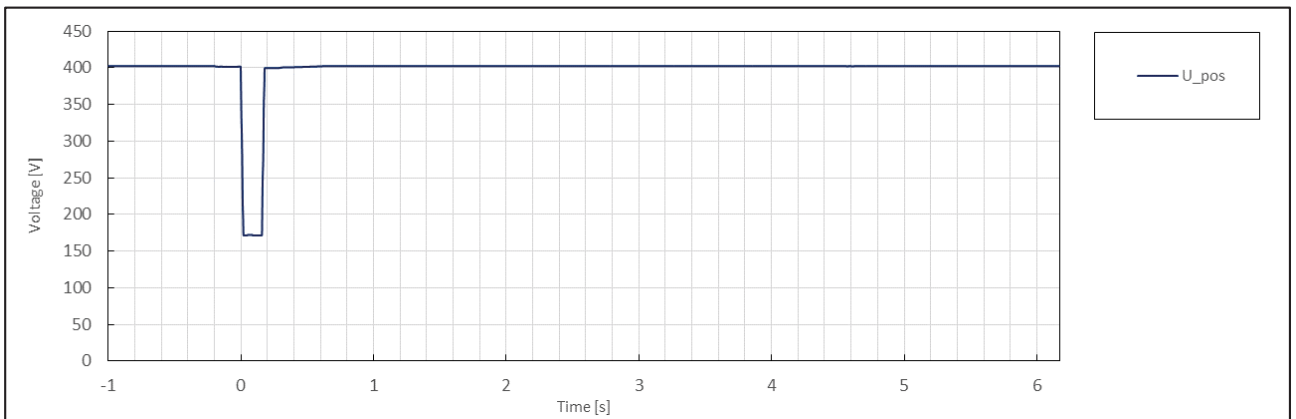
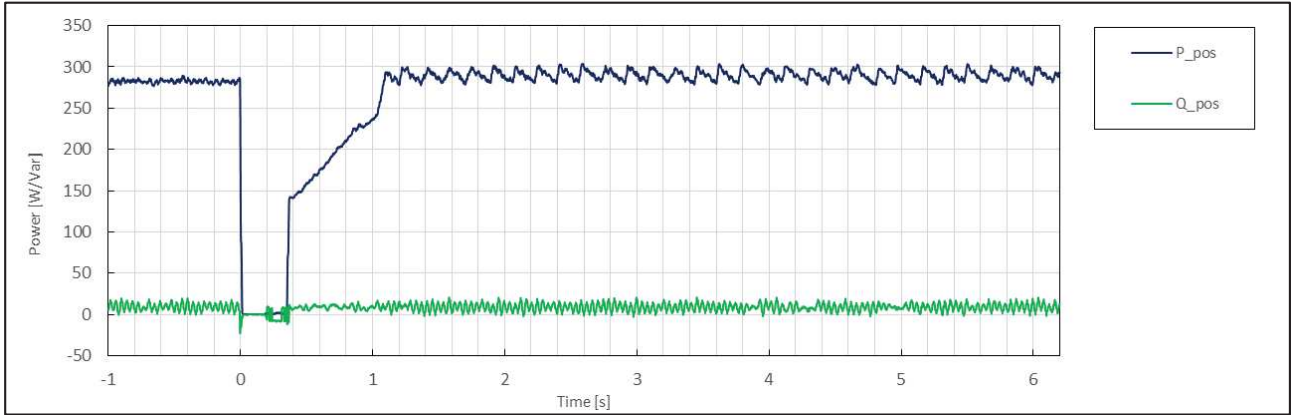

|                     | No. | Parameter  | Phase ref.      | Time ref.                       | unit       | Result        |
|---------------------|-----|--|-----------------|---------------------------------|------------|---------------|
| General Info.       | 0   | Test number  | --              | --                              | --         | 2.1           |
|                     | 1   | Date   | --              | --                              | dd.mm.yyyy | 3.1.2020      |
|                     | 2   | Time (start of test)                                   | --              | --                              | hh:mm:ss.f | 13:28:46      |
|                     | 3   | Fault type (phase)                                     | --              | --                              |            | 3-phase fault |
|                     | 4   | Setting voltage depth                                  | Line to line    | --                              | p.u.       | 0.50          |
|                     | 5   | Setting dip duration                                   |                 | --                              |            | 1535          |
|                     | 6   | Point of fault entry                                   | Total           | --                              | ms         | 0             |
|                     | 7   | Point of fault clearance                               | Total           | --                              | ms         | 1534          |
|                     | 8   | Fault duration in empty load test                      | Total           | --                              | ms         | 1535          |
|                     | 9   | Voltage depth/height in empty load test                | Total           | t1+100ms to t2 and t1-10s to t1 | p.u.       | 0.50          |
|                     | 10  |  | Pos.            |                                 | p.u.       | 0.50          |
| Before dip <t1      | 11  | Voltage  | Line to neutral | t1-100s to t1                   | p.u.       | 1.02          |
|                     | 12  | Current  | Pos.            | t1-500ms to t1-100ms            | p.u.       | 0.32          |
|                     | 13  | Active power   | Total           | t1-10s to t1                    | p.u.       | 1.01          |
|                     | 14  |  | Pos.            |                                 |            | 0.98          |
|                     | 15  | Reactive power   | Total           | t1-10s to t1                    | p.u.       | 0.05          |
|                     | 16  |  | Pos.            |                                 |            | 0.05          |
|                     | 17  | Cos $\phi$   | --              | t1-10s to t1                    | --         | 0.999         |
| During dip t1 to t2 | 18  | Voltage  | Line to neutral | t1+100ms to t2-20ms             | p.u.       | 0.50          |
|                     | 19  | Line current   | Phase 1         | t1+60ms                         | p.u.       | N/A           |
|                     | 20  |  | Phase 2         |                                 |            | N/A           |
|                     | 21  |  | Phase 3         |                                 |            | 0.01          |
|                     | 22  | Line current   | Phase 1         | t1+100ms                        | p.u.       | N/A           |
|                     | 23  |  | Phase 2         |                                 |            | N/A           |
|                     | 24  |  | Phase 3         |                                 |            | 0.01          |
|                     | 25  | Active power   | Total           | t1+100ms to t2-20ms             | p.u.       | 0.00          |
|                     | 26  |  | Pos.            |                                 |            | 0.00          |
| After dip > t2      | 27  | Voltage  | Line to neutral | t2+3s to t2+10s                 | p.u.       | 1.02          |
|                     | 28  | Active power   | Total           | t2+3s to t2+10s                 | p.u.       | 1.01          |
|                     | 29  |  | Pos.            |                                 |            | 0.98          |
|                     | 39  | Active power rising time                               | Pos.            | --                              | s          | 0.514         |
|                     | 31  | Reactive power   | Total           | t2+3s to t2+10s                 | p.u.       | 0.05          |
|                     | 32  |  | Pos.            |                                 |            | 0.05          |
|                     | 33  | Reactive power rising time                             | Pos.            | --                              | s          | N/A           |
|                     | 34  | PGU does not disconnect from grid till 60s after fault | --              | t2 to t2+60s                    | Yes / No   | No            |

Test No. 2.1 idle test

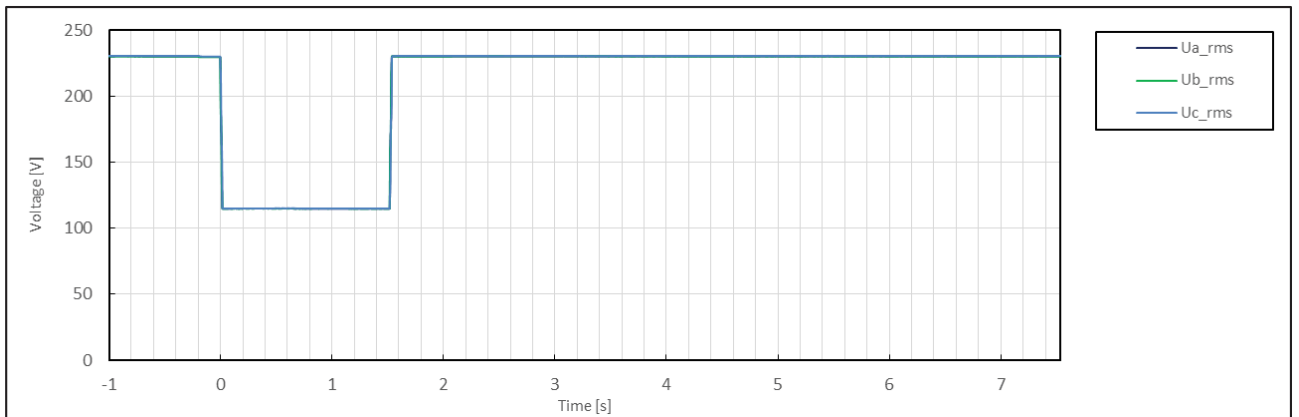
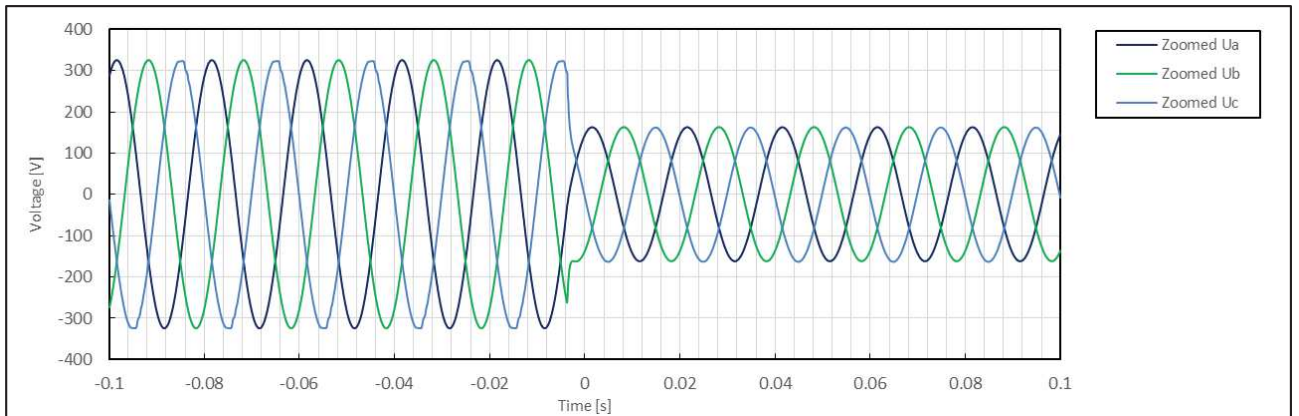
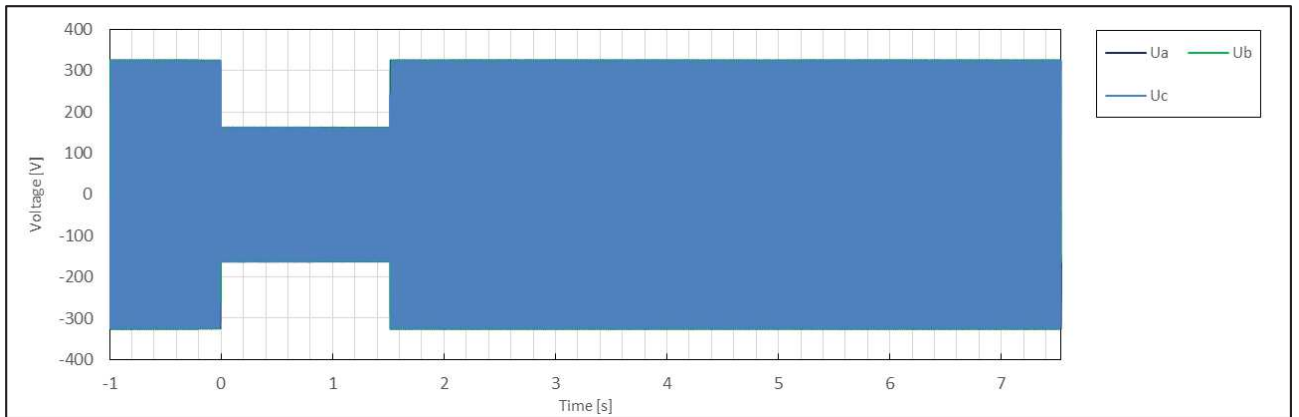



Test No. 2.1 with PGU

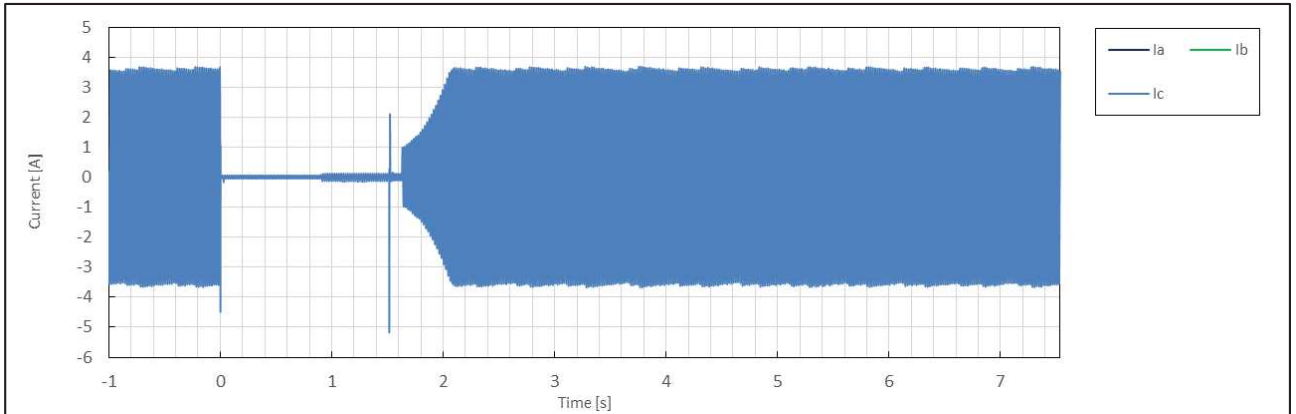
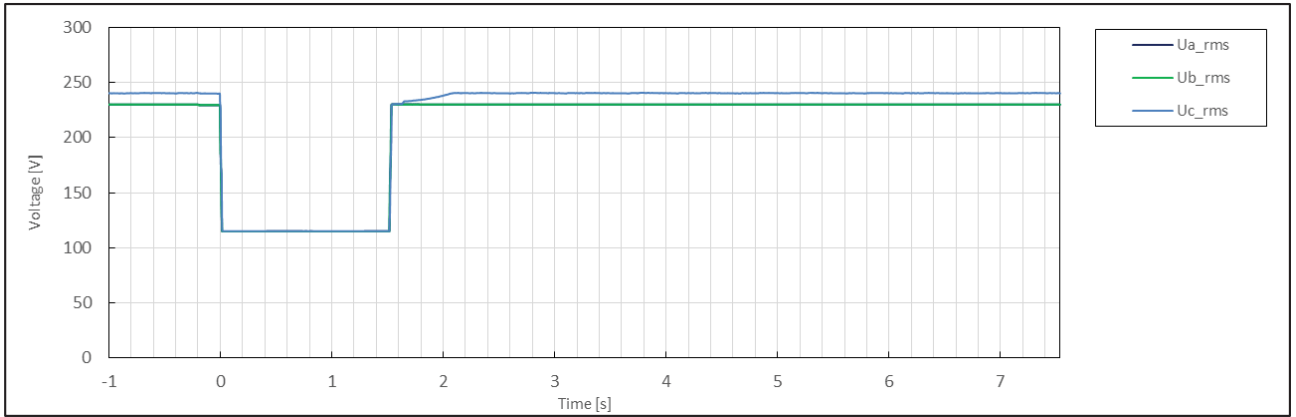
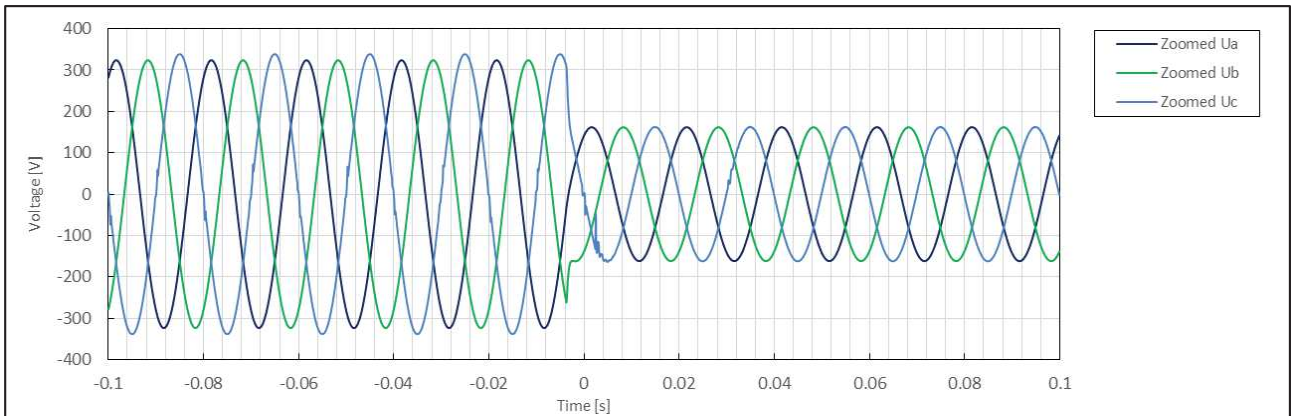
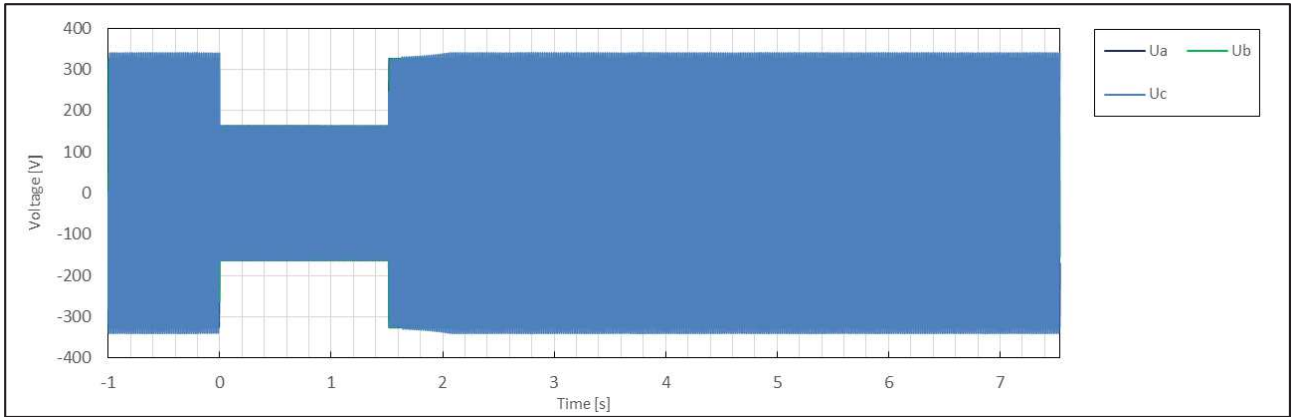

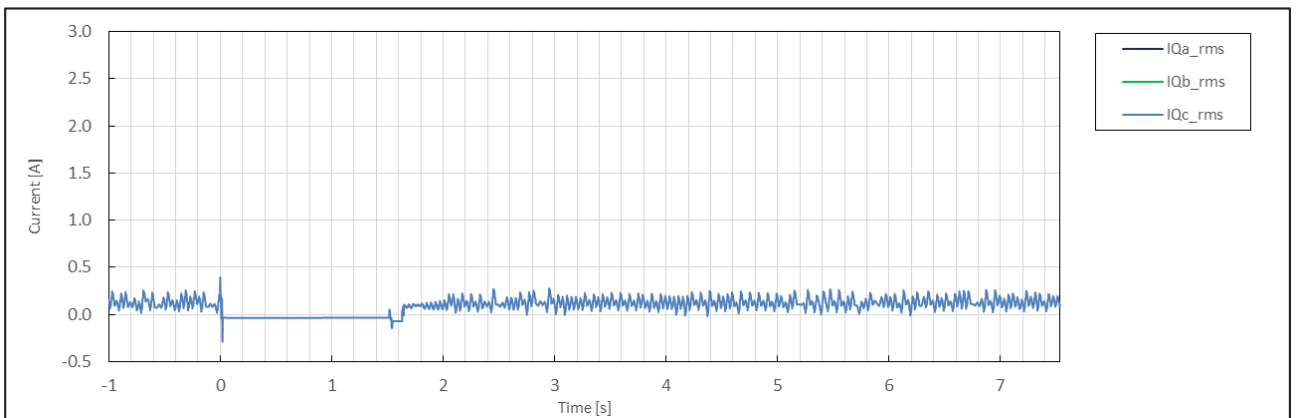
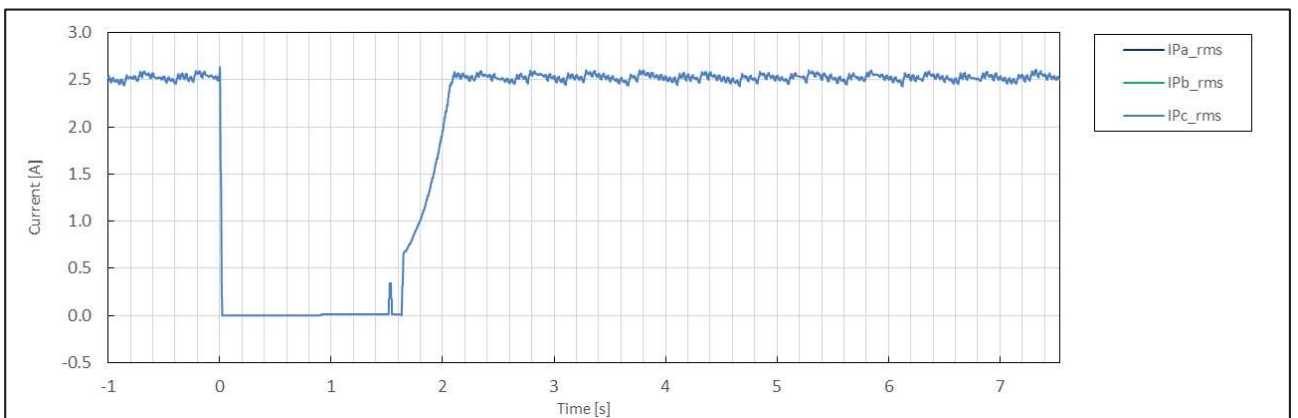
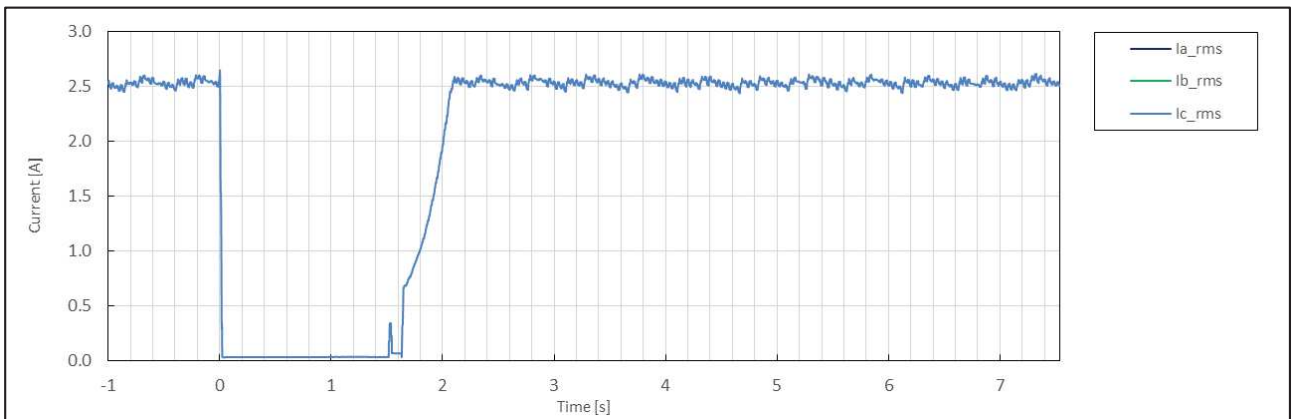
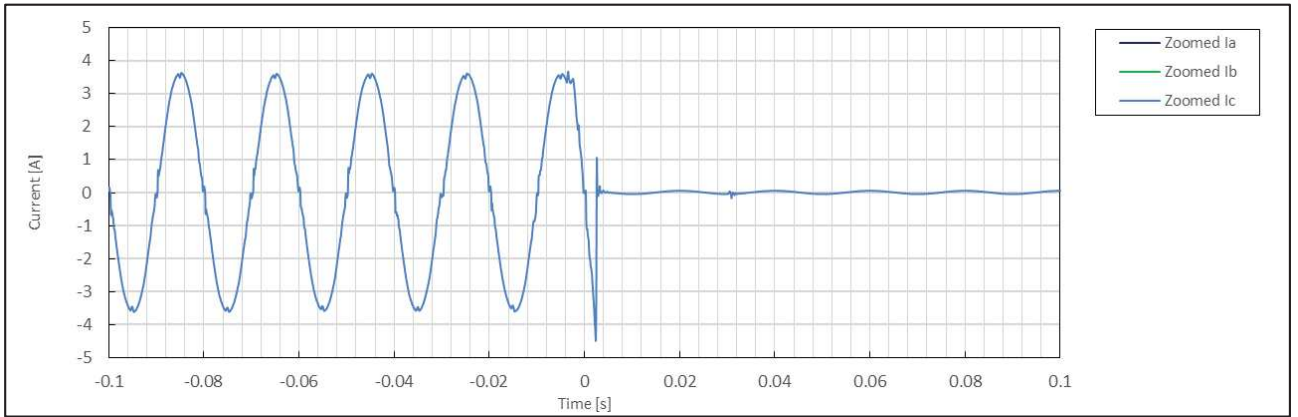

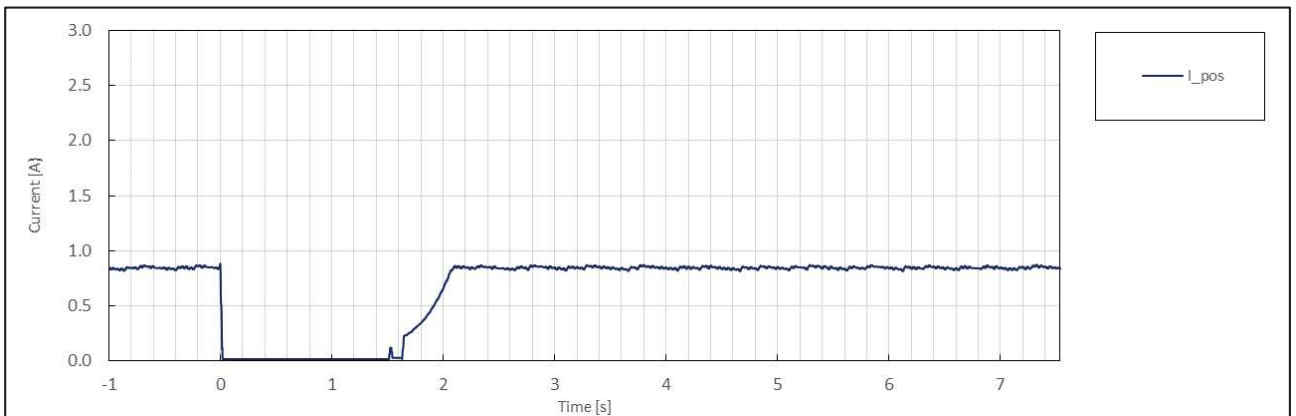
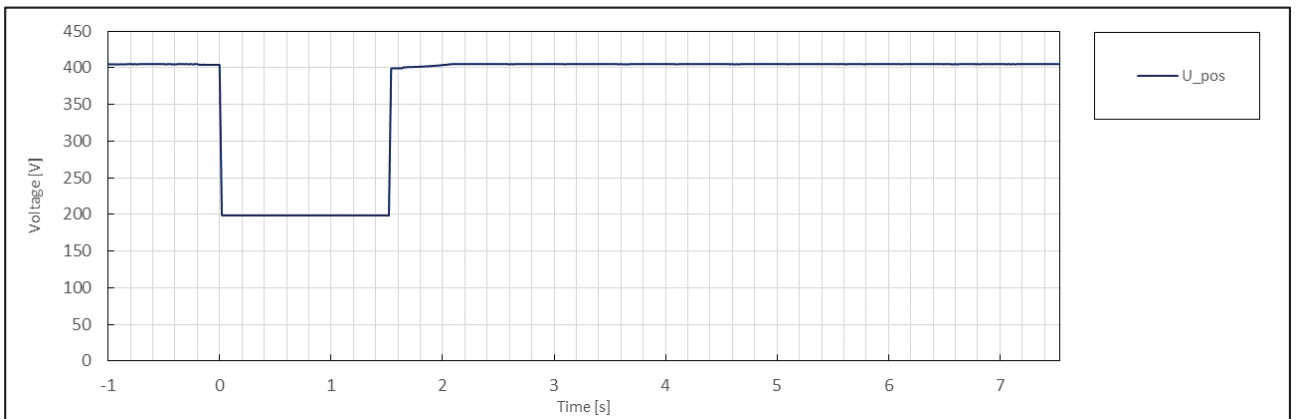
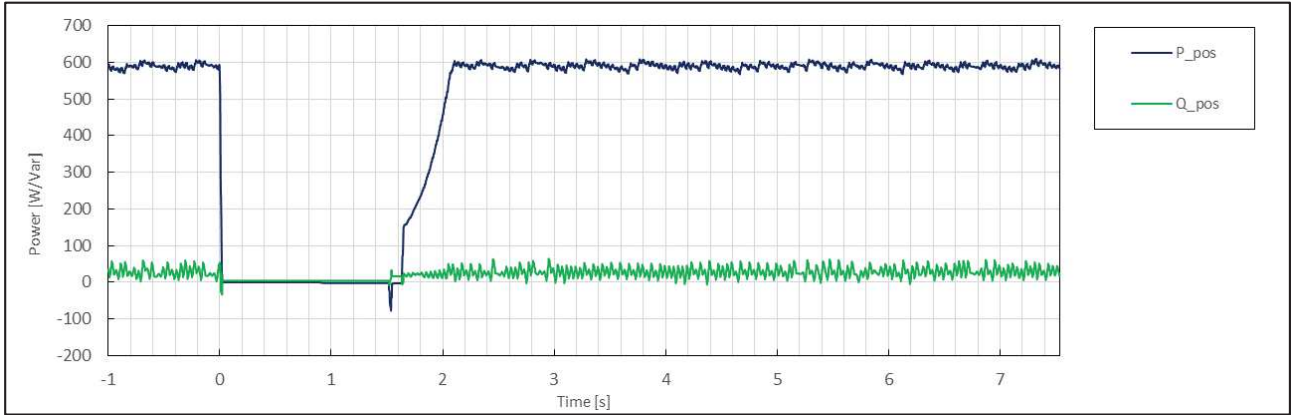

|                     | No. | Parameter  | Phase ref.      | Time ref.                       | unit       | Result        |
|---------------------|-----|--|-----------------|---------------------------------|------------|---------------|
| General Info.       | 0   | Test number  | --              | --                              | --         | 2.2           |
|                     | 1   | Date   | --              | --                              | dd.mm.yyyy | 3.1.2020      |
|                     | 2   | Time (start of test)                                   | --              | --                              | hh:mm:ss.f | 13:35:16      |
|                     | 3   | Fault type (phase)                                     | --              | --                              |            | 3-phase fault |
|                     | 4   | Setting voltage depth                                  | Line to line    | --                              | p.u.       | 0.50          |
|                     | 5   | Setting dip duration                                   |                 | --                              |            | 1535          |
|                     | 6   | Point of fault entry                                   | Total           | --                              | ms         | 0             |
|                     | 7   | Point of fault clearance                               | Total           | --                              | ms         | 1534          |
|                     | 8   | Fault duration in empty load test                      | Total           | --                              | ms         | 1535          |
|                     | 9   | Voltage depth/height in empty load test                | Total           | t1+100ms to t2 and t1-10s to t1 | p.u.       | 0.50          |
|                     | 10  |  | Pos.            |                                 | p.u.       | 0.50          |
| Before dip <t1      | 11  | Voltage  | Line to neutral | t1-100s to t1                   | p.u.       | 1.01          |
|                     | 12  | Current  | Pos.            | t1-500ms to t1-100ms            | p.u.       | 0.11          |
|                     | 13  | Active power   | Total           | t1-10s to t1                    | p.u.       | 0.33          |
|                     | 14  |  | Pos.            |                                 |            | 0.33          |
|                     | 15  | Reactive power   | Total           | t1-10s to t1                    | p.u.       | 0.04          |
|                     | 16  |  | Pos.            |                                 |            | 0.02          |
|                     | 17  | Cos $\phi$   | --              | t1-10s to t1                    | --         | 0.994         |
| During dip t1 to t2 | 18  | Voltage  | Line to neutral | t1+100ms to t2-20ms             | p.u.       | 0.50          |
|                     | 19  | Line current   | Phase 1         | t1+60ms                         | p.u.       | N/A           |
|                     | 20  |  | Phase 2         |                                 |            | N/A           |
|                     | 21  |  | Phase 3         |                                 |            | 0.01          |
|                     | 22  | Line current   | Phase 1         | t1+100ms                        | p.u.       | N/A           |
|                     | 23  |  | Phase 2         |                                 |            | N/A           |
|                     | 24  |  | Phase 3         |                                 |            | 0.01          |
|                     | 25  | Active power   | Total           | t1+100ms to t2-20ms             | p.u.       | 0.00          |
|                     | 26  |  | Pos.            |                                 |            | 0.00          |
| After dip > t2      | 27  | Voltage  | Line to neutral | t2+3s to t2+10s                 | p.u.       | 1.01          |
|                     | 28  | Active power   | Total           | t2+3s to t2+10s                 | p.u.       | 0.33          |
|                     | 29  |  | Pos.            |                                 |            | 0.33          |
|                     | 39  | Active power rising time                               | Pos.            | --                              | s          | 0.175         |
|                     | 31  | Reactive power   | Total           | t2+3s to t2+10s                 | p.u.       | 0.04          |
|                     | 32  |  | Pos.            |                                 |            | 0.02          |
|                     | 33  | Reactive power rising time                             | Pos.            | --                              | s          | N/A           |
|                     | 34  | PGU does not disconnect from grid till 60s after fault | --              | t2 to t2+60s                    | Yes / No   | No            |

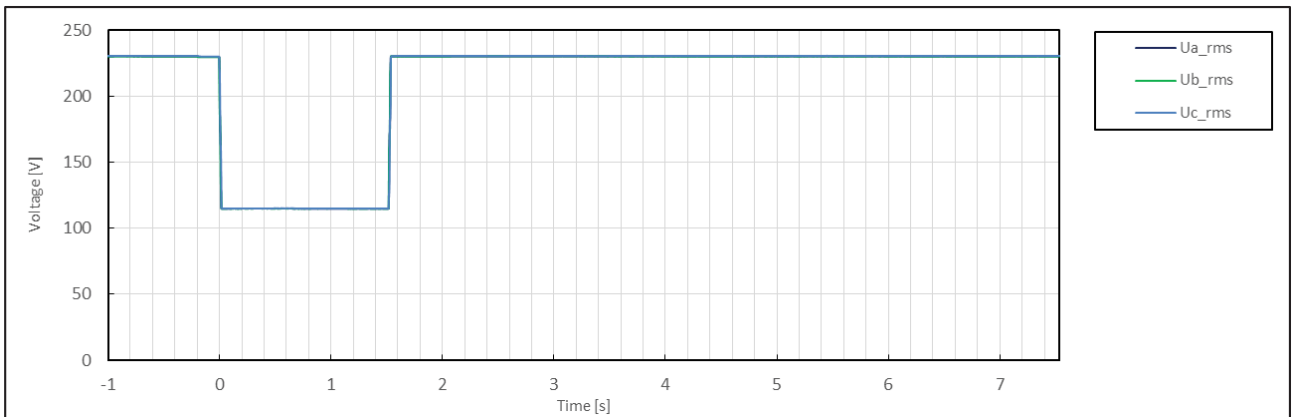
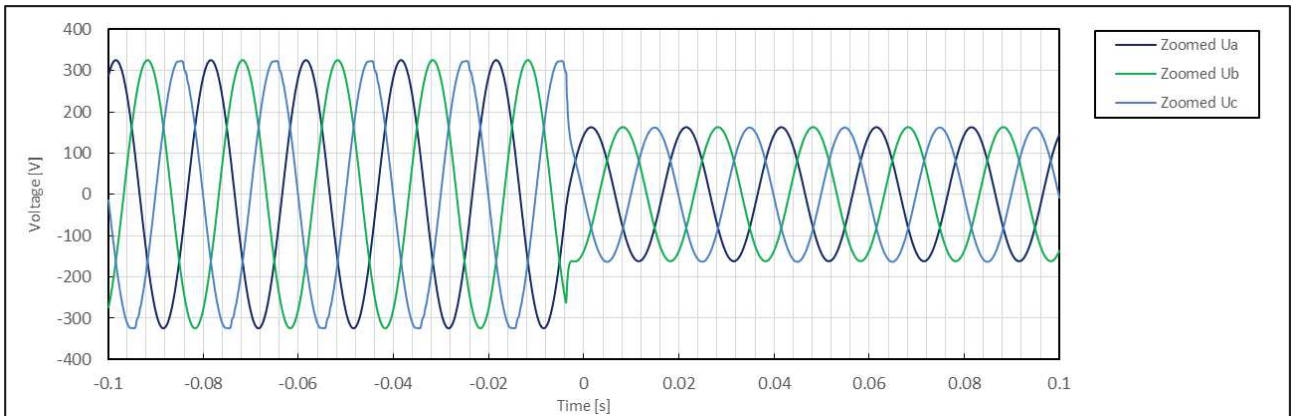
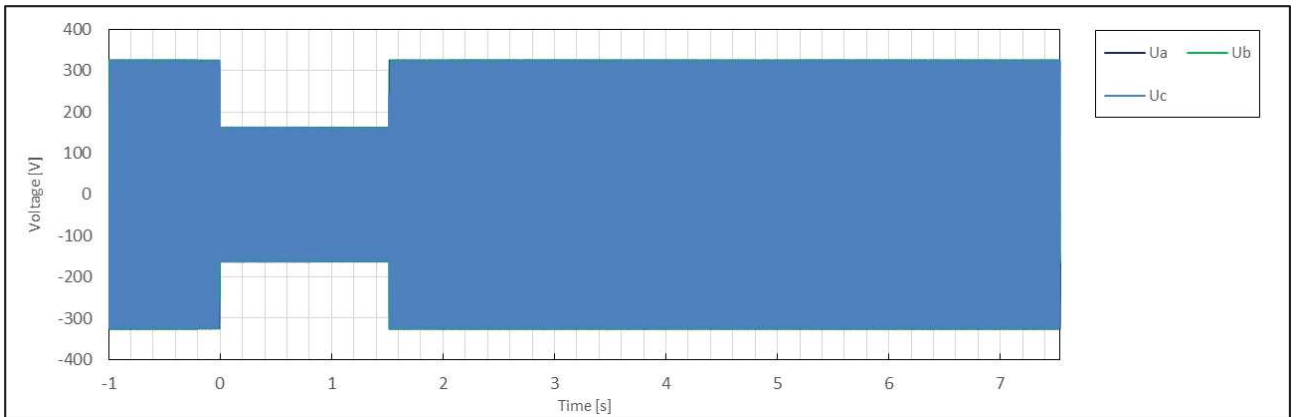

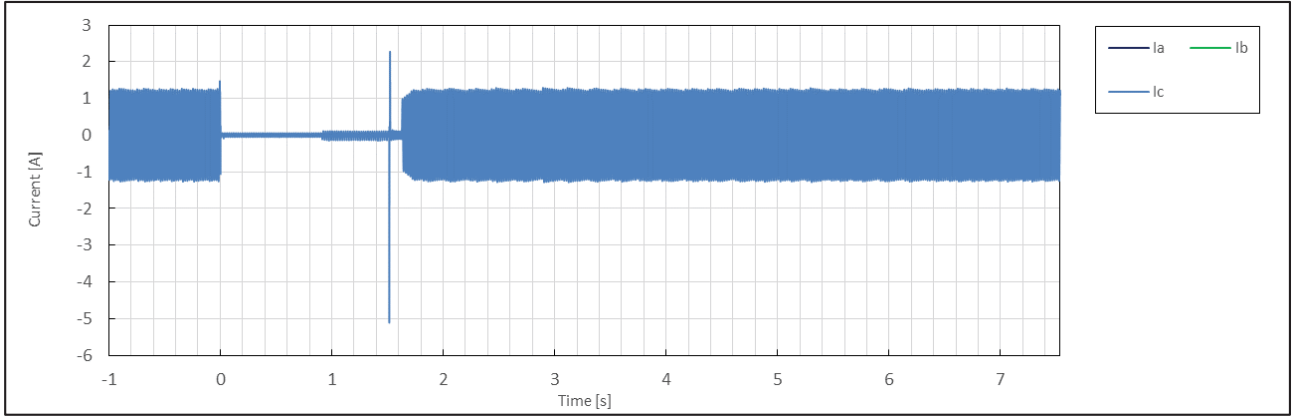
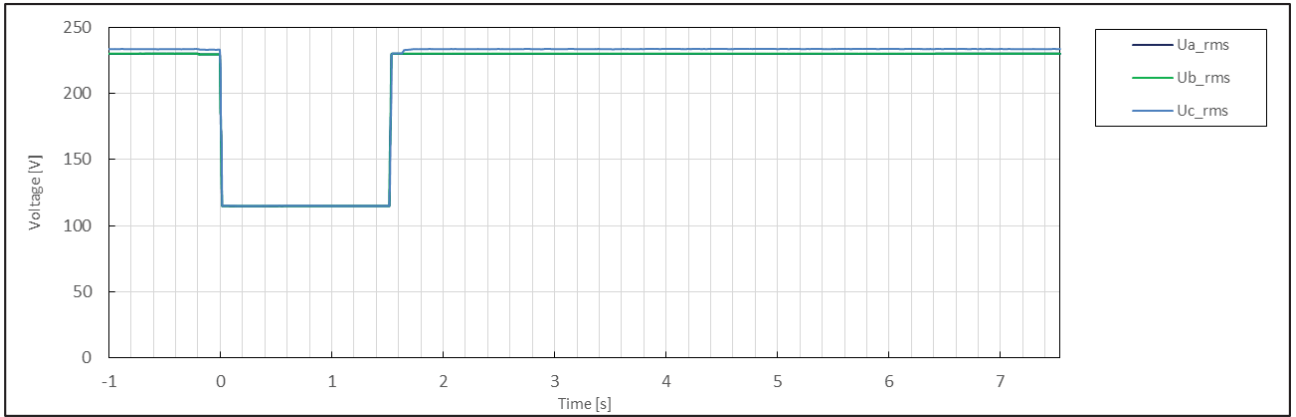
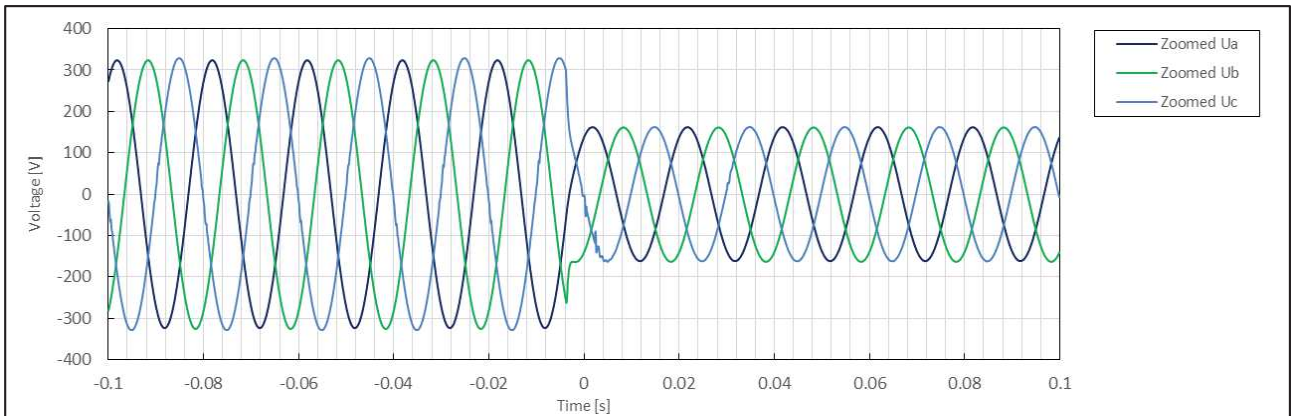
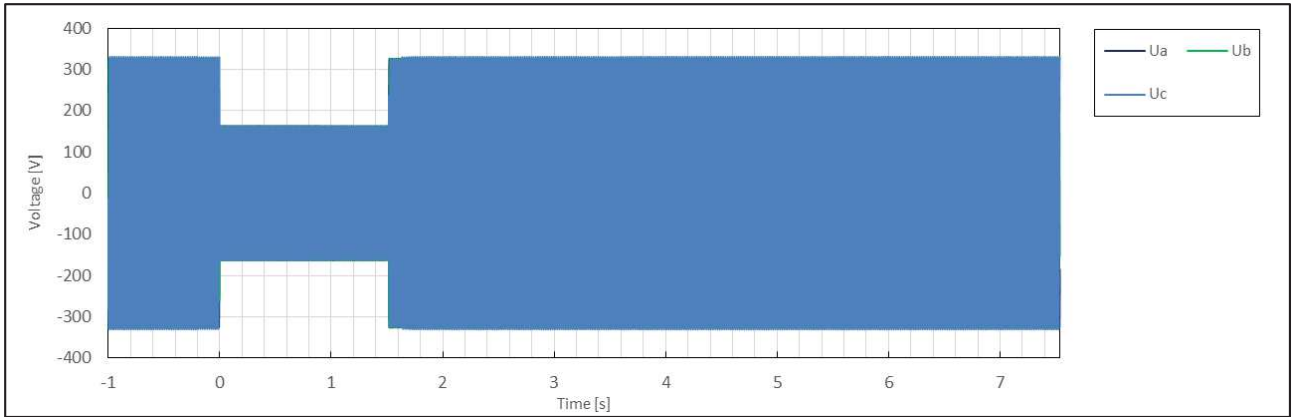

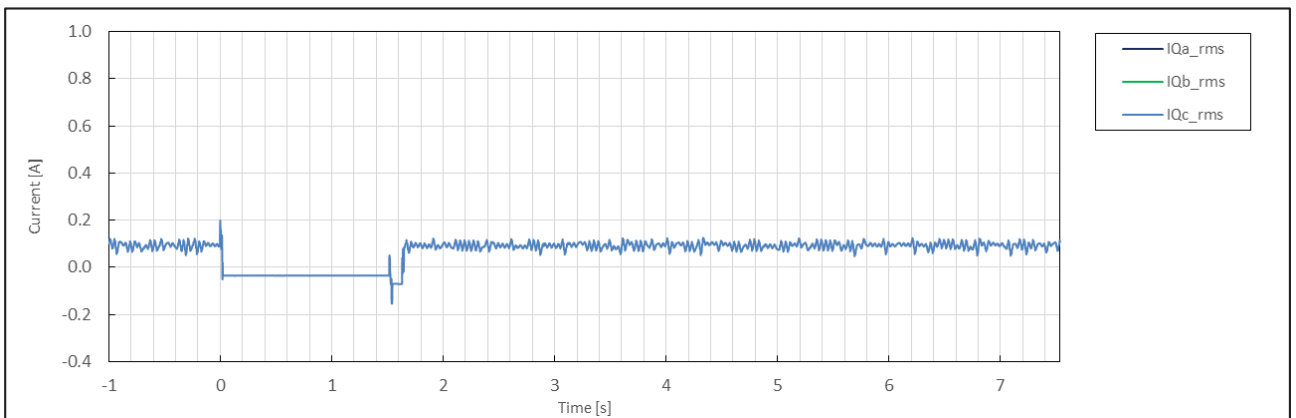
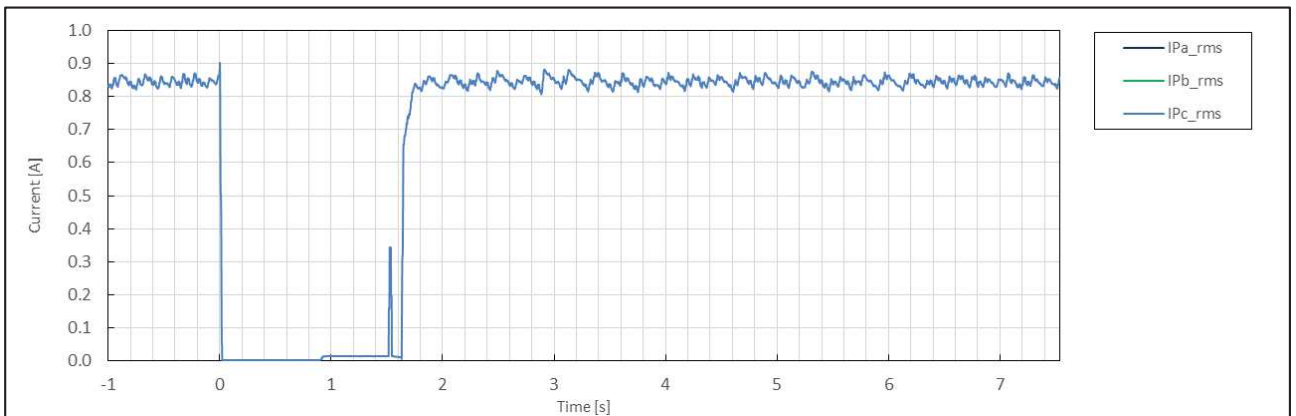
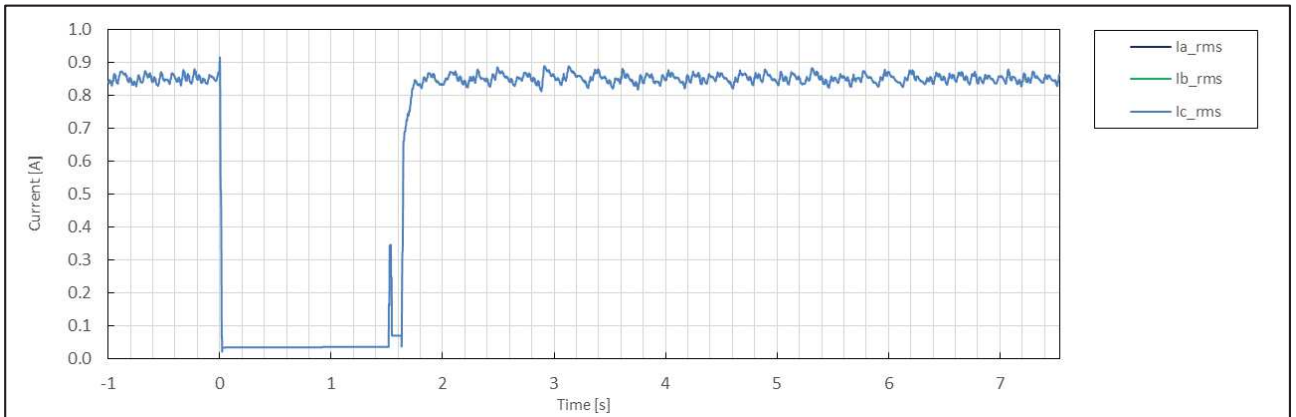
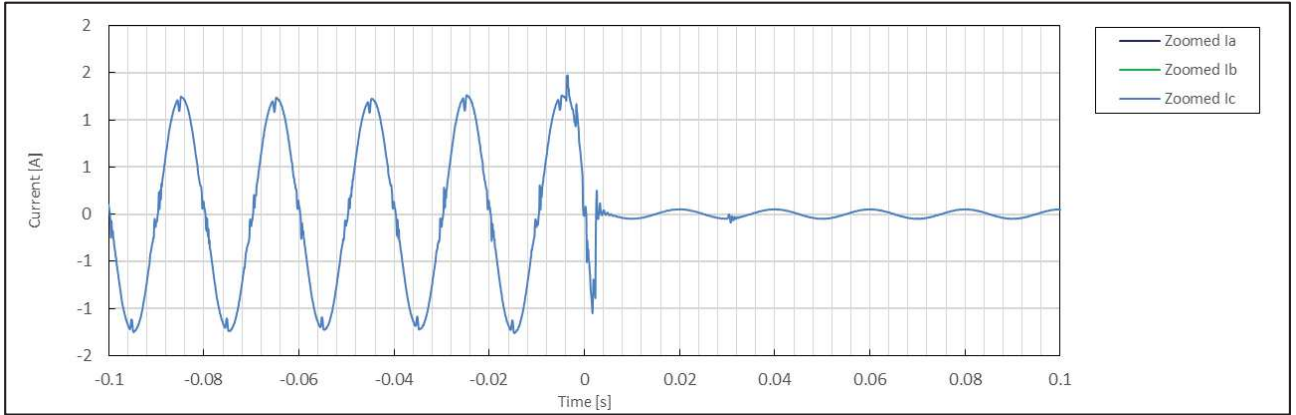

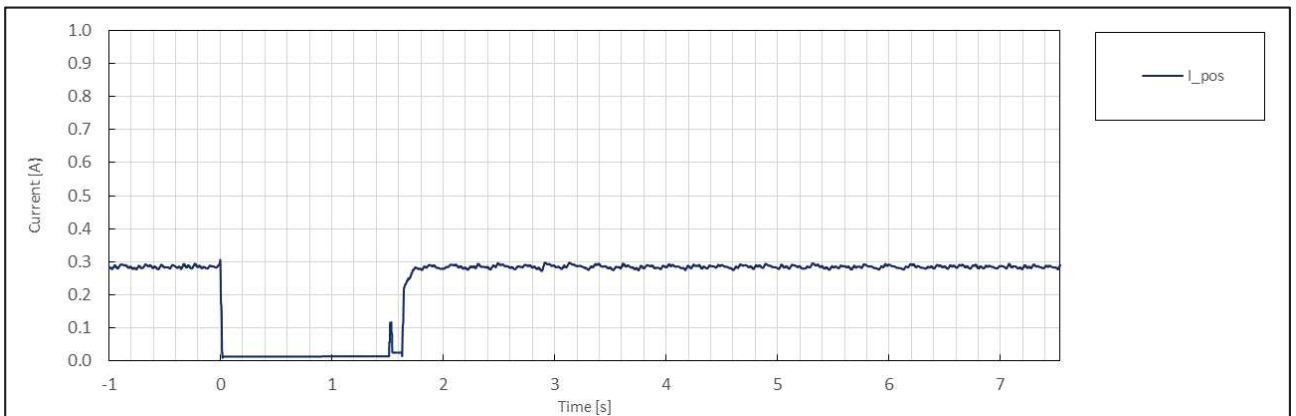
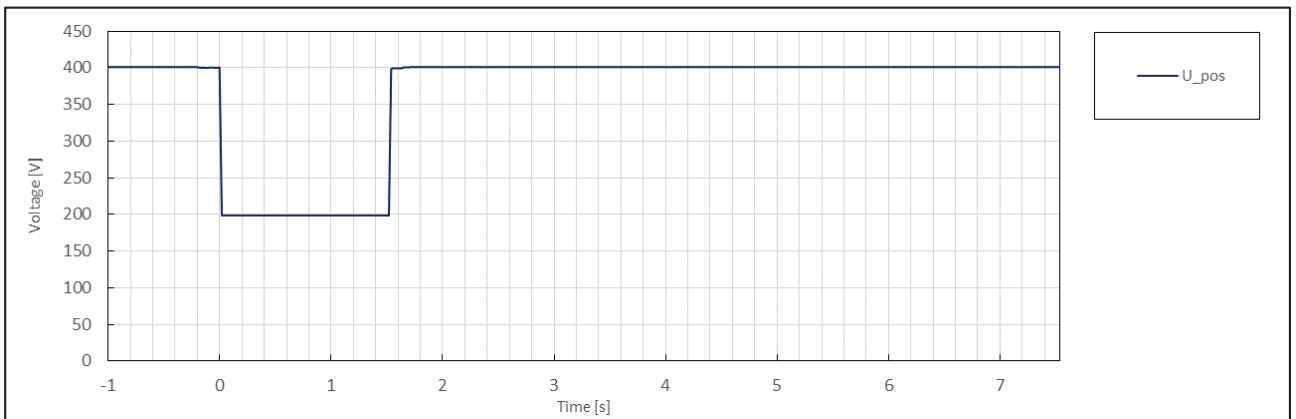
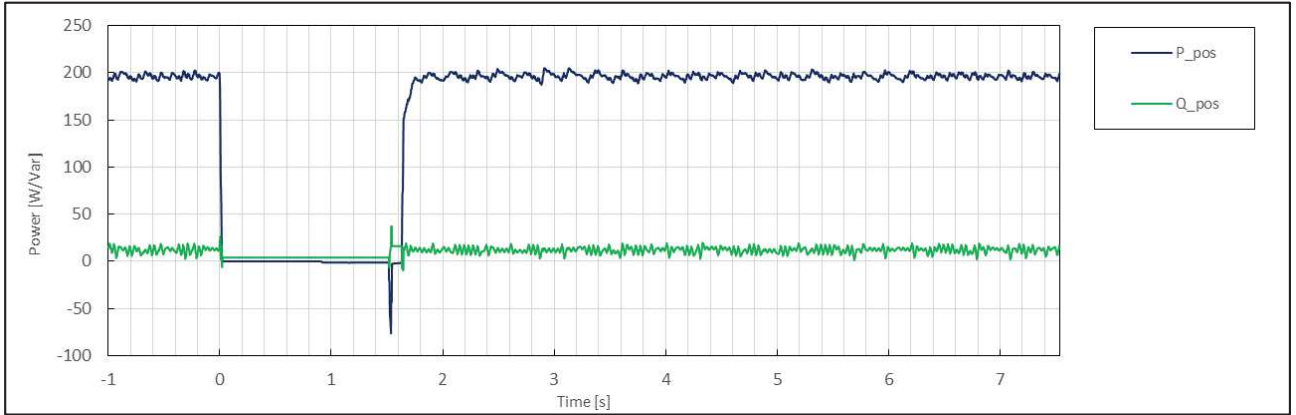



|                     | No.  | Parameter                               | Phase ref.      | Time ref.                       | unit       | Result        |
|---------------------|--|---|-----------------|---------------------------------|------------|---------------|
| General Info.       | 0  | Test number                             | --              | --                              | --         | 2.3           |
|                     | 1  | Date                                    | --              | --                              | dd.mm.yyyy | 3.1.2020      |
|                     | 2  | Time (start of test)                    | --              | --                              | hh:mm:ss.f | 13:42:25      |
|                     | 3  | Fault type (phase)                      | --              | --                              |            | 2-phase fault |
|                     | 4  | Setting voltage depth                   | Line to line    | --                              | p.u.       | 0.50          |
|                     | 5  | Setting dip duration                    |                 | --                              |            | 1530          |
|                     | 6  | Point of fault entry                    | Total           | --                              | ms         | 0             |
|                     | 7  | Point of fault clearance                | Total           | --                              | ms         | 1529          |
|                     | 8  | Fault duration in empty load test       | Total           | --                              | ms         | 1530          |
|                     | 9  | Voltage depth/height in empty load test | Total           | t1+100ms to t2 and t1-10s to t1 | p.u.       | 0.76          |
| 10                  | Pos.   |   |                 | p.u.                            | 0.66       |               |
| Before dip <t1      | 11   | Voltage                                 | Line to neutral | t1-100s to t1                   | p.u.       | 1.02          |
|                     | 12   | Current                                 | Pos.            | t1-500ms to t1-100ms            | p.u.       | 0.30          |
|                     | 13   | Active power                            | Total           | t1-10s to t1                    | p.u.       | 0.91          |
|                     | 14   |   | Pos.            |                                 |            | 0.91          |
|                     | 15   | Reactive power                          | Total           | t1-10s to t1                    | p.u.       | 0.00          |
|                     | 16   |   | Pos.            |                                 |            | 0.00          |
| 17                  | Cos $\varphi$  | --                                      | t1-10s to t1    | --                              | 0.999      |               |
| During dip t1 to t2 | 18   | Voltage                                 | Line to neutral | t1+100ms to t2-20ms             | p.u.       | 1.00          |
|                     | 19   | Line current                            | Phase 1         | t1+60ms                         | p.u.       | N/A           |
|                     | 20   |   | Phase 2         |                                 |            | N/A           |
|                     | 21   |   | Phase 3         |                                 |            | 0.00          |
|                     | 22   | Line current                            | Phase 1         | t1+100ms                        | p.u.       | N/A           |
|                     | 23   |   | Phase 2         |                                 |            | N/A           |
|                     | 24   |   | Phase 3         |                                 |            | 0.00          |
|                     | 25   | Active power                            | Total           | t1+100ms to t2-20ms             | p.u.       | 0.00          |
| 26                  | Pos.   |   | 0.00            |                                 |            |               |
| After dip > t2      | 27   | Voltage                                 | Line to neutral | t2+3s to t2+10s                 | p.u.       | 1.00          |
|                     | 28   | Active power                            | Total           | t2+3s to t2+10s                 | p.u.       | 0.91          |
|                     | 29   |   | Pos.            |                                 |            | 0.91          |
|                     | 39   | Active power rising time                | Pos.            | --                              | s          | 0.687         |
|                     | 31   | Reactive power                          | Total           | t2+3s to t2+10s                 | p.u.       | -0.01         |
|                     | 32   |   | Pos.            |                                 |            | -0.01         |
|                     | 33   | Reactive power rising time              | Pos.            | --                              | s          | N/A           |
| 34                  | PGU does not disconnect from grid till 60s after fault | --                                      | t2 to t2+60s    | Yes / No                        | No         |               |

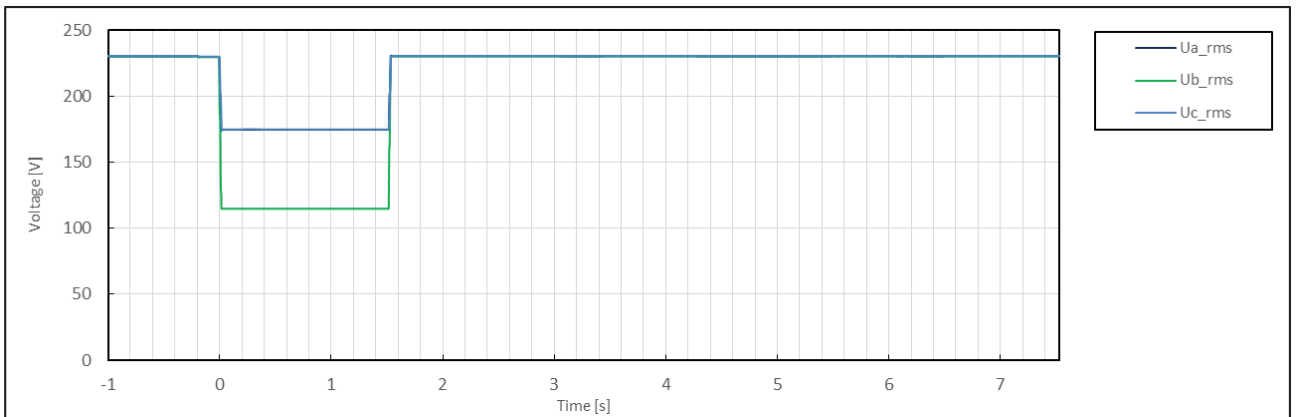
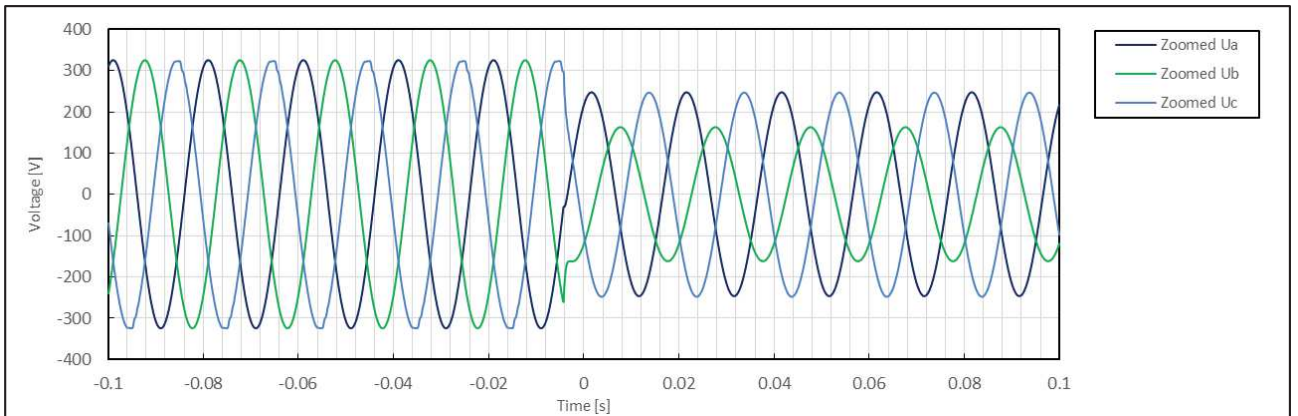
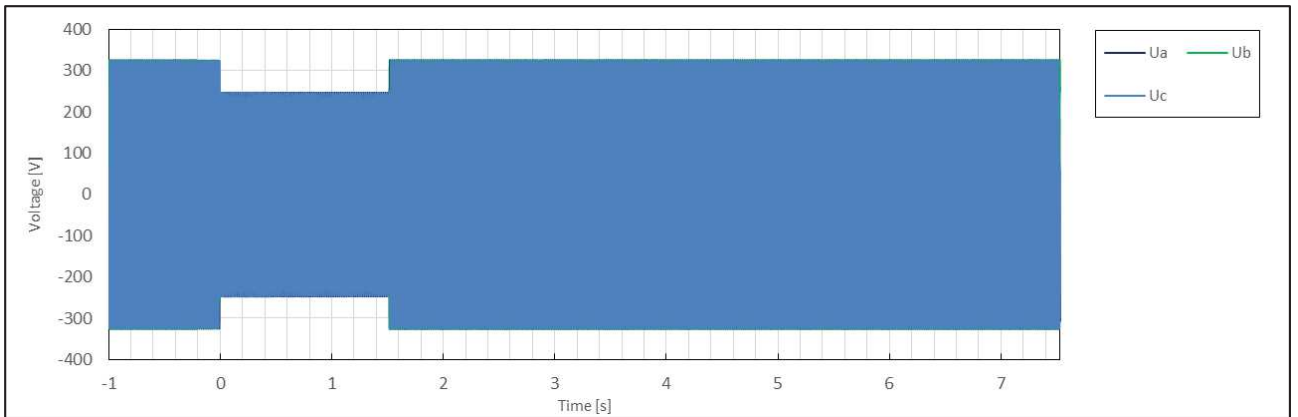

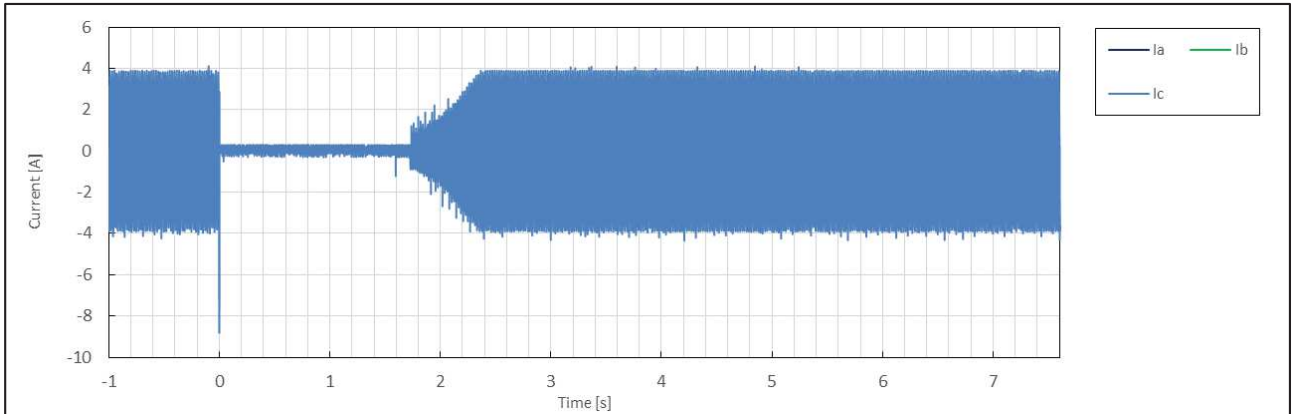
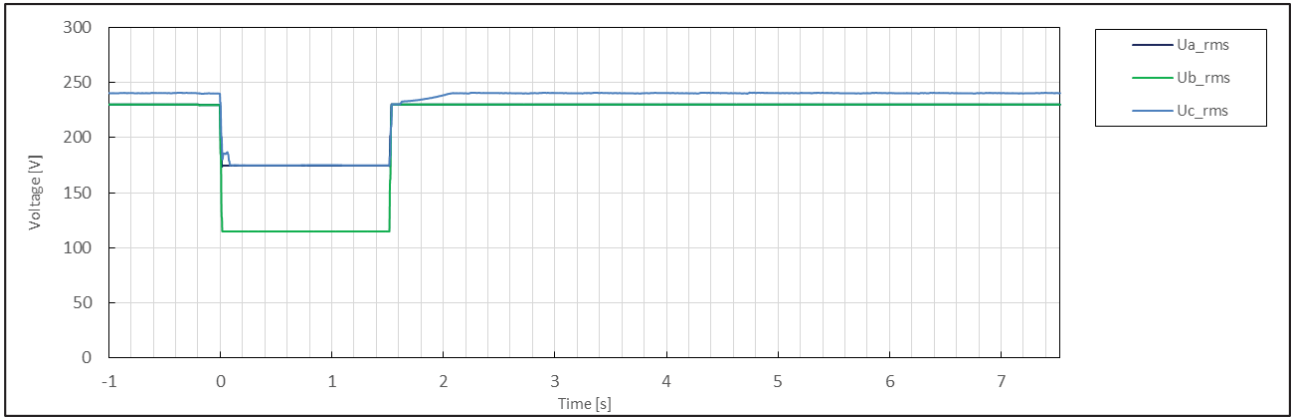
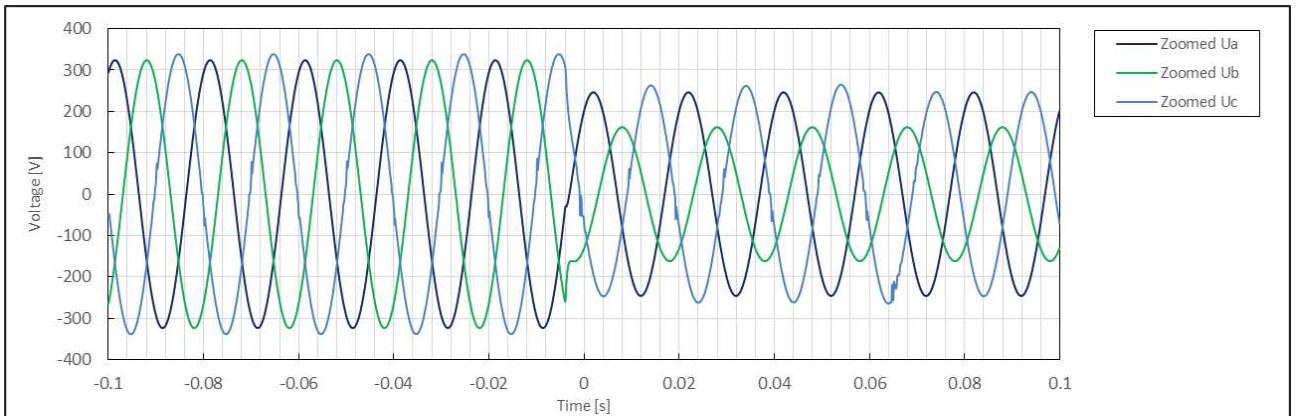
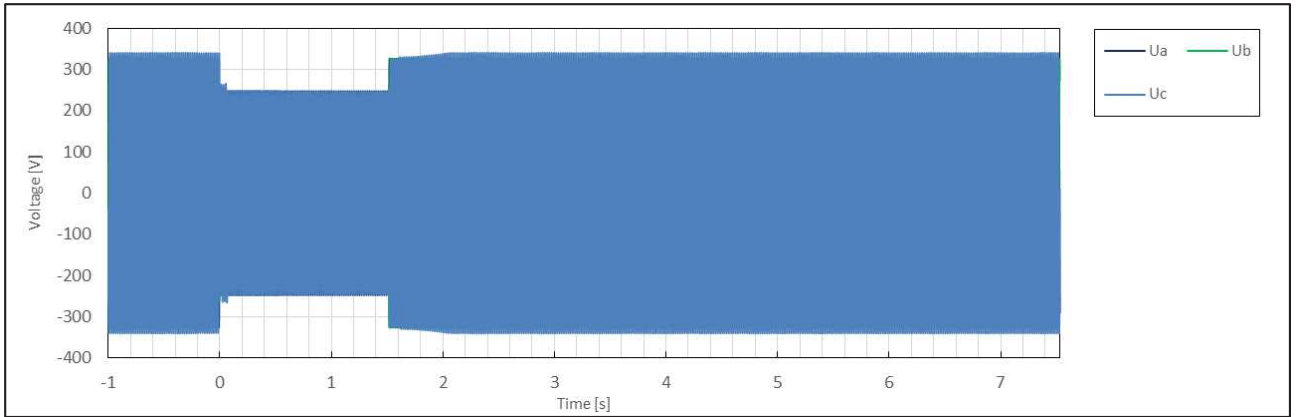

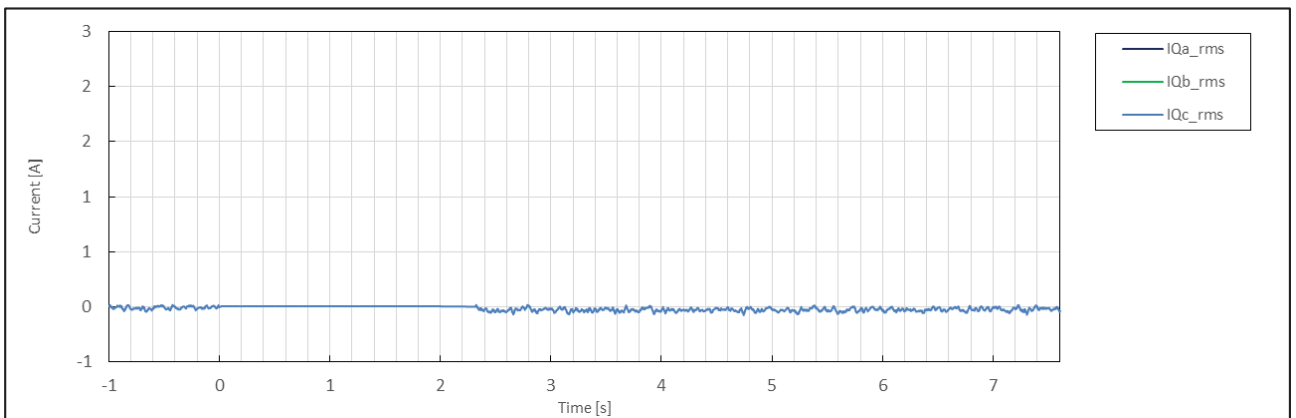
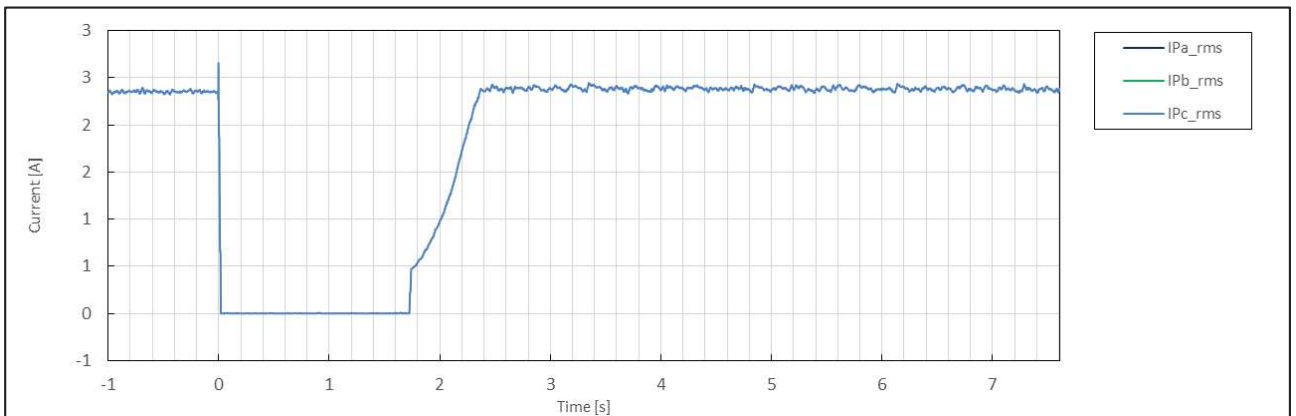
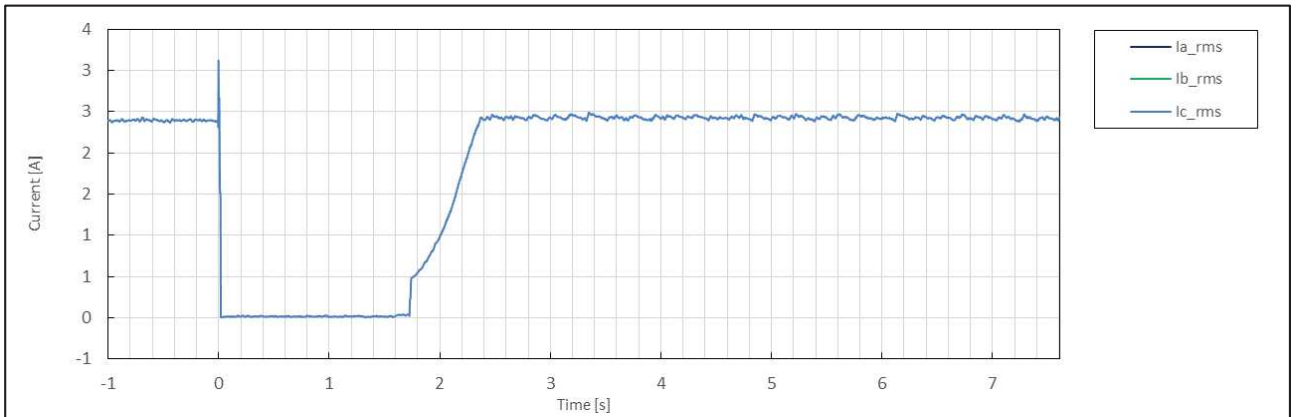
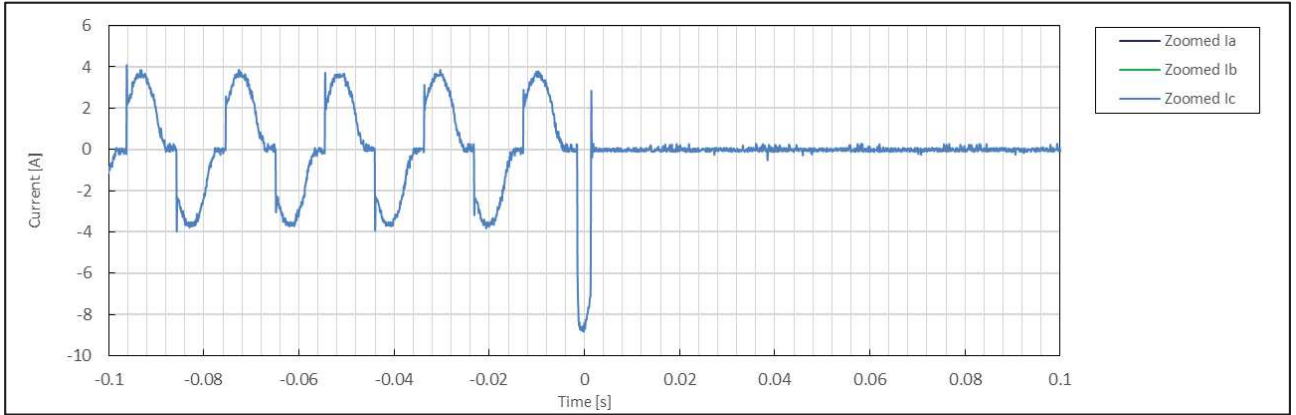

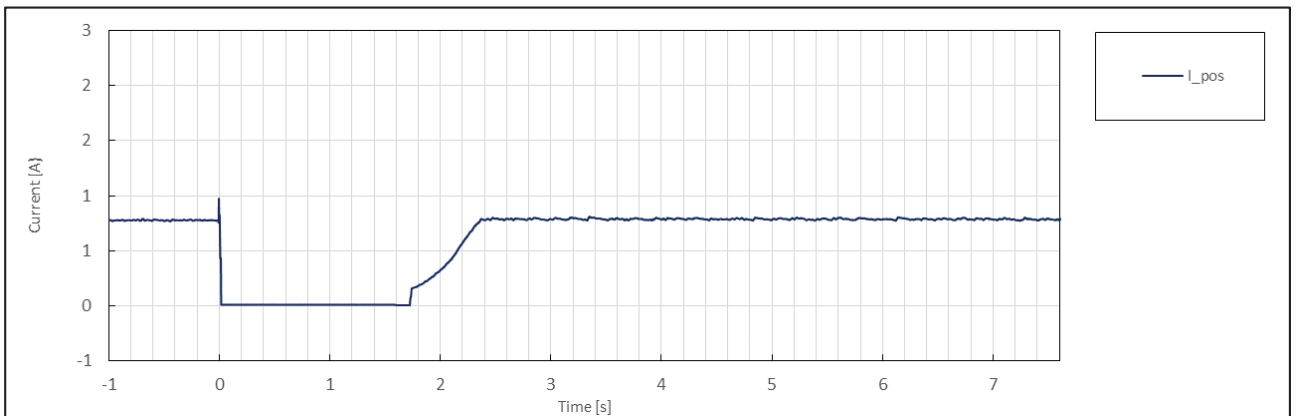
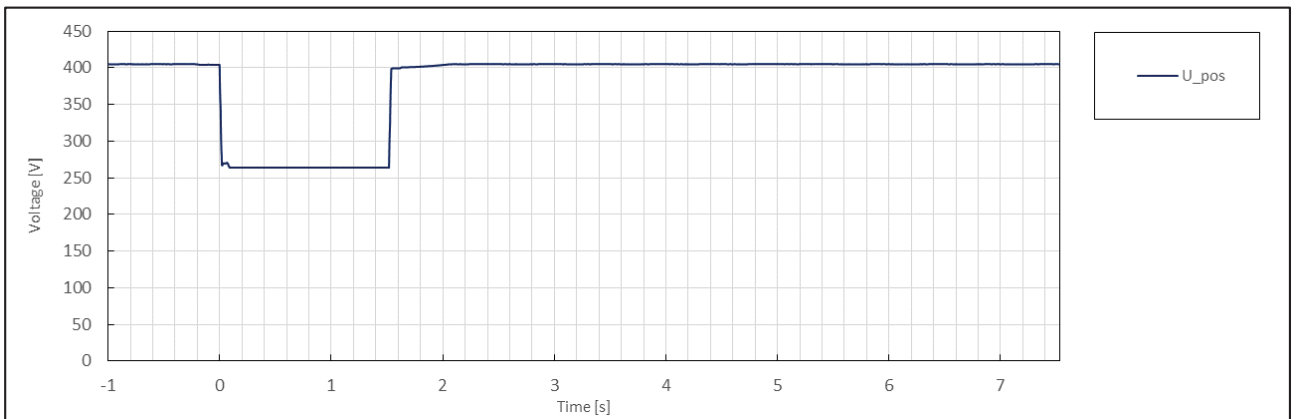
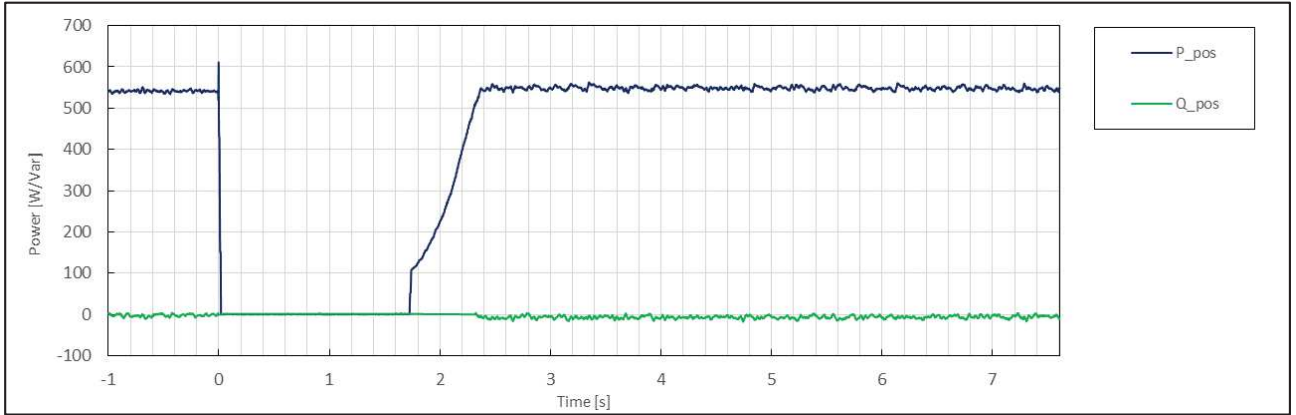

|                     | No. | Parameter  | Phase ref.      | Time ref.                       | unit       | Result        |
|---------------------|-----|--|-----------------|---------------------------------|------------|---------------|
| General Info.       | 0   | Test number  | --              | --                              | --         | 2.4           |
|                     | 1   | Date   | --              | --                              | dd.mm.yyyy | 3.1.2020      |
|                     | 2   | Time (start of test)                                   | --              | --                              | hh:mm:ss.f | 13:45:35      |
|                     | 3   | Fault type (phase)                                     | --              | --                              |            | 2-phase fault |
|                     | 4   | Setting voltage depth                                  | Line to line    | --                              | p.u.       | 0.50          |
|                     | 5   | Setting dip duration                                   |                 | --                              |            | 1530          |
|                     | 6   | Point of fault entry                                   | Total           | --                              | ms         | 0             |
|                     | 7   | Point of fault clearance                               | Total           | --                              | ms         | 1529          |
|                     | 8   | Fault duration in empty load test                      | Total           | --                              | ms         | 1530          |
|                     | 9   | Voltage depth/height in empty load test                | Total           | t1+100ms to t2 and t1-10s to t1 | p.u.       | 0.76          |
|                     | 10  |  | Pos.            |                                 | p.u.       | 0.66          |
| Before dip <t1      | 11  | Voltage  | Line to neutral | t1-100s to t1                   | p.u.       | 1.01          |
|                     | 12  | Current  | Pos.            | t1-500ms to t1-100ms            | p.u.       | 0.11          |
|                     | 13  | Active power   | Total           | t1-10s to t1                    | p.u.       | 0.33          |
|                     | 14  |  | Pos.            |                                 |            | 0.33          |
|                     | 15  | Reactive power   | Total           | t1-10s to t1                    | p.u.       | 0.04          |
|                     | 16  |  | Pos.            |                                 |            | 0.02          |
|                     | 17  | Cos $\varphi$  | --              | t1-10s to t1                    | --         | 0.997         |
| During dip t1 to t2 | 18  | Voltage  | Line to neutral | t1+100ms to t2-20ms             | p.u.       | 0.76          |
|                     | 19  | Line current   | Phase 1         | t1+60ms                         | p.u.       | N/A           |
|                     | 20  |  | Phase 2         |                                 |            | N/A           |
|                     | 21  |  | Phase 3         |                                 |            | 0.10          |
|                     | 22  | Line current   | Phase 1         | t1+100ms                        | p.u.       | N/A           |
|                     | 23  |  | Phase 2         |                                 |            | N/A           |
|                     | 24  |  | Phase 3         |                                 |            | 0.02          |
|                     | 25  | Active power   | Total           | t1+100ms to t2-20ms             | p.u.       | 0.00          |
|                     | 26  |  | Pos.            |                                 |            | 0.00          |
| After dip > t2      | 27  | Voltage  | Line to neutral | t2+3s to t2+10s                 | p.u.       | 1.01          |
|                     | 28  | Active power   | Total           | t2+3s to t2+10s                 | p.u.       | 0.33          |
|                     | 29  |  | Pos.            |                                 |            | 0.33          |
|                     | 39  | Active power rising time                               | Pos.            | --                              | s          | 0.146         |
|                     | 31  | Reactive power   | Total           | t2+3s to t2+10s                 | p.u.       | 0.04          |
|                     | 32  |  | Pos.            |                                 |            | 0.02          |
|                     | 33  | Reactive power rising time                             | Pos.            | --                              | s          | N/A           |
|                     | 34  | PGU does not disconnect from grid till 60s after fault | --              | t2 to t2+60s                    | Yes / No   | No            |

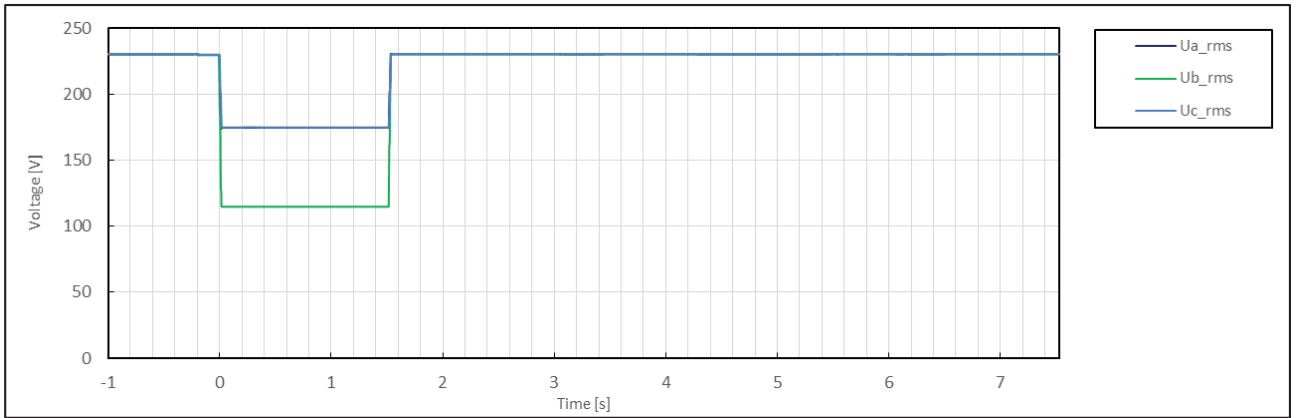
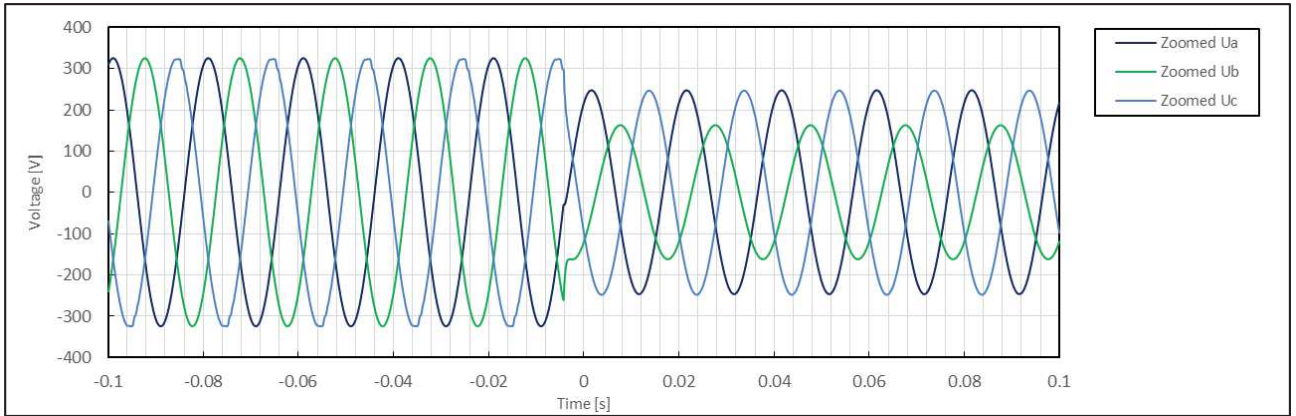
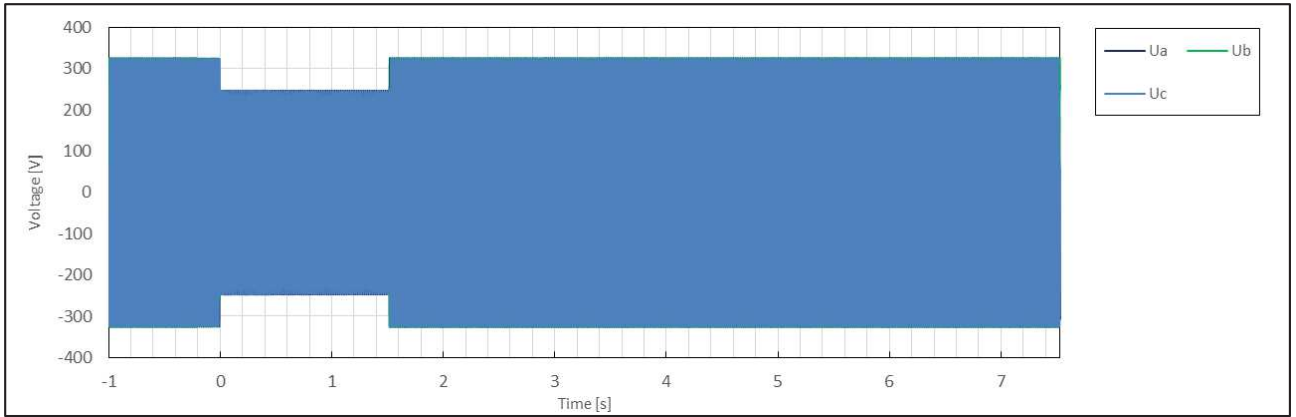

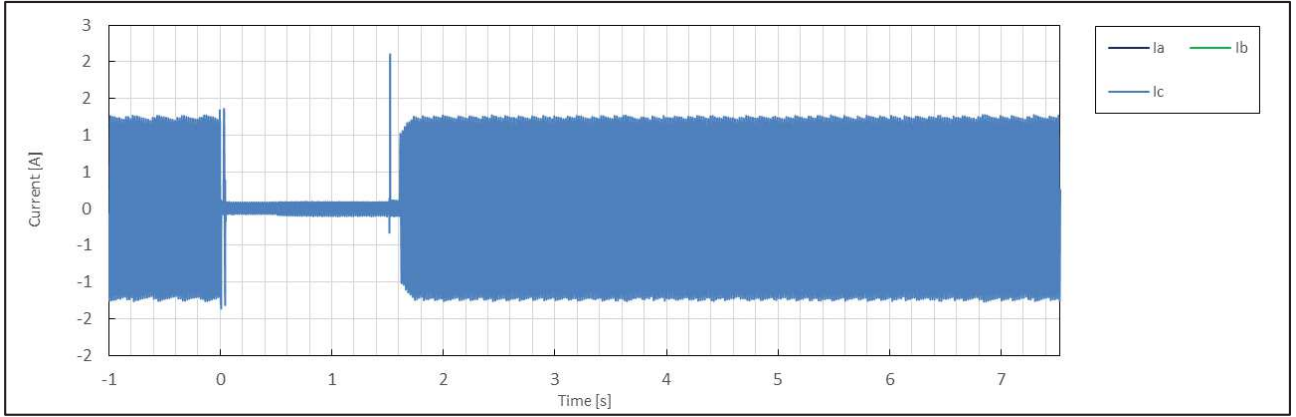
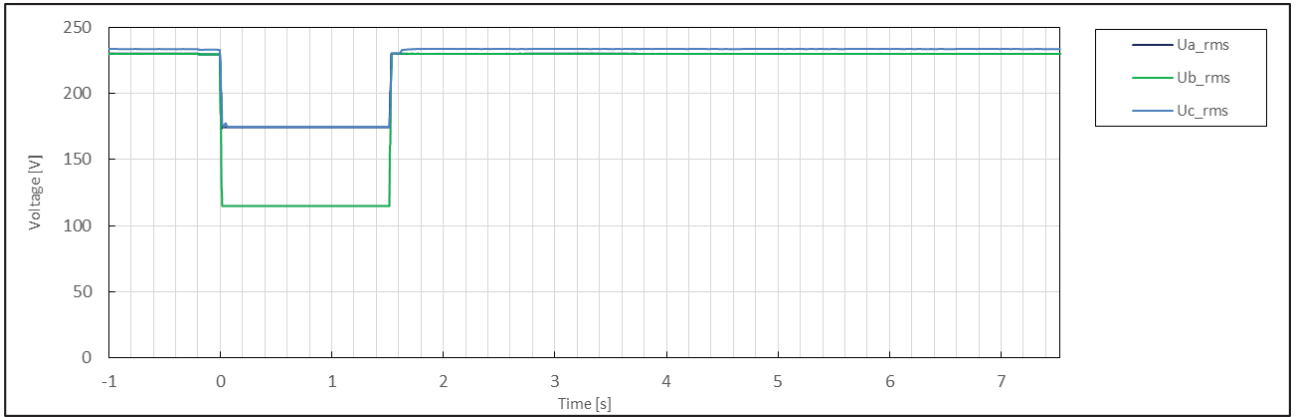
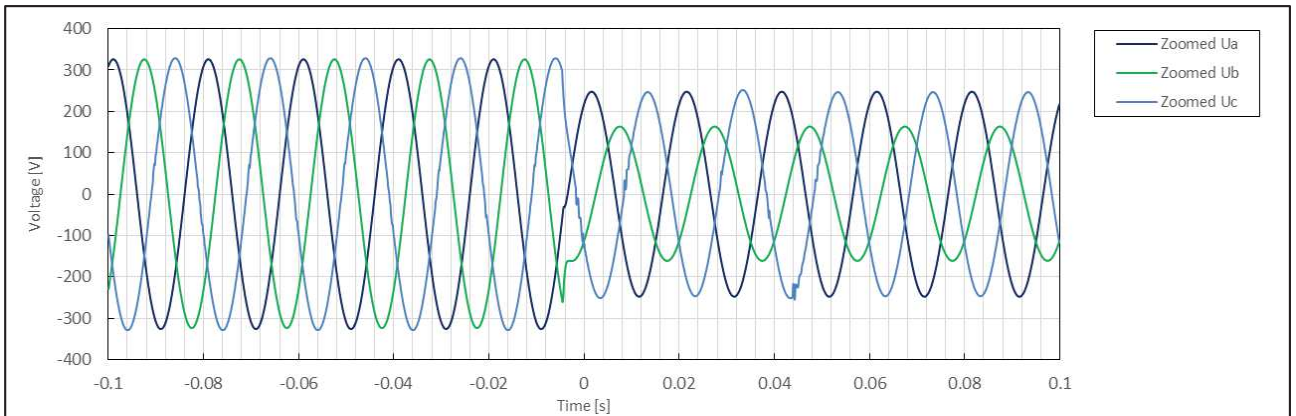
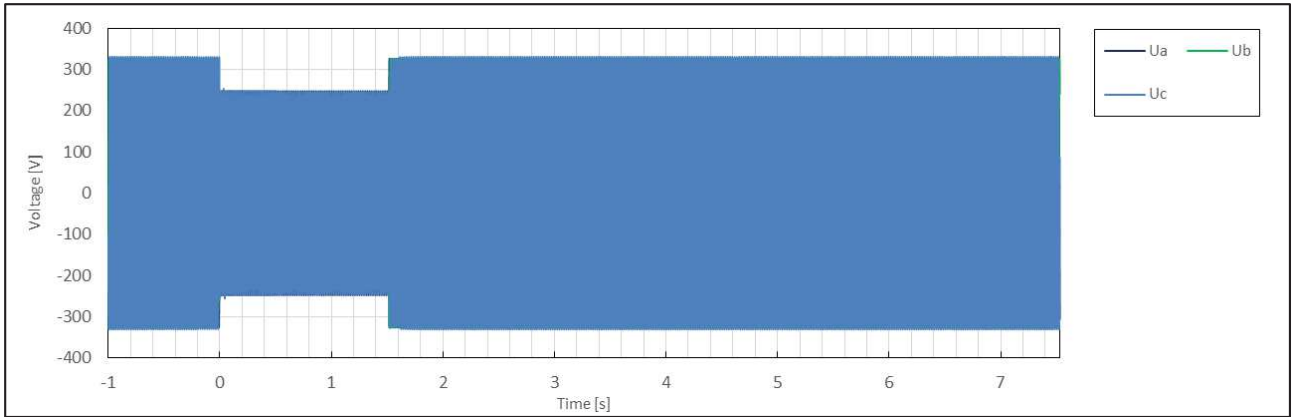



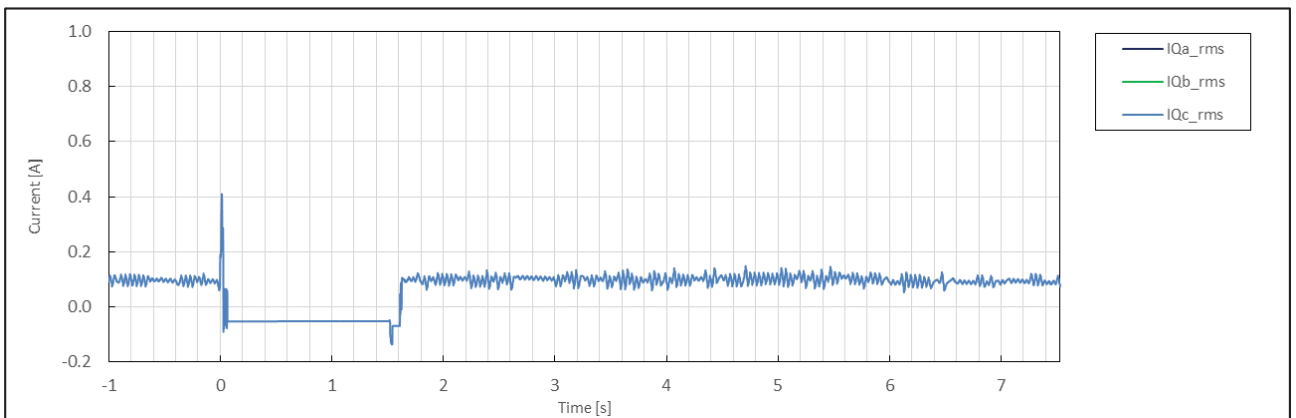
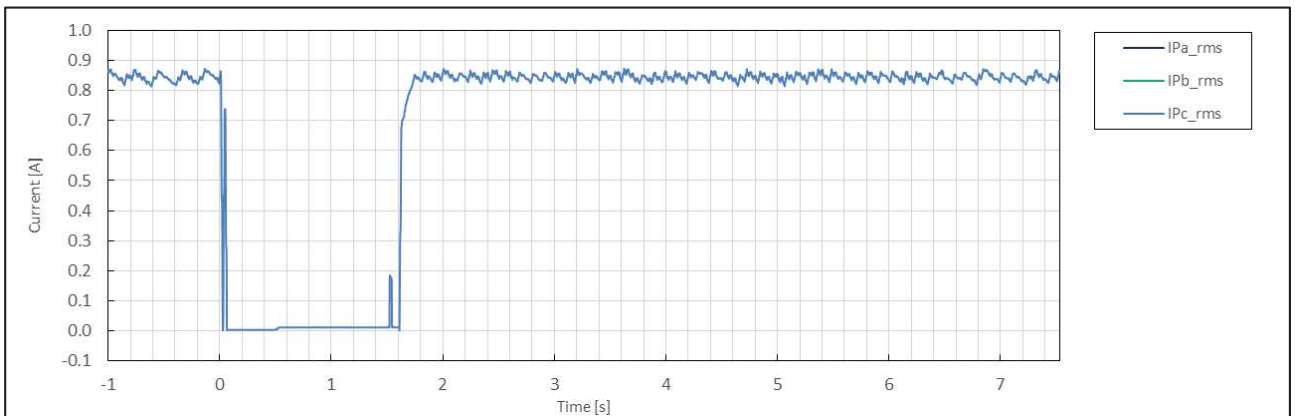
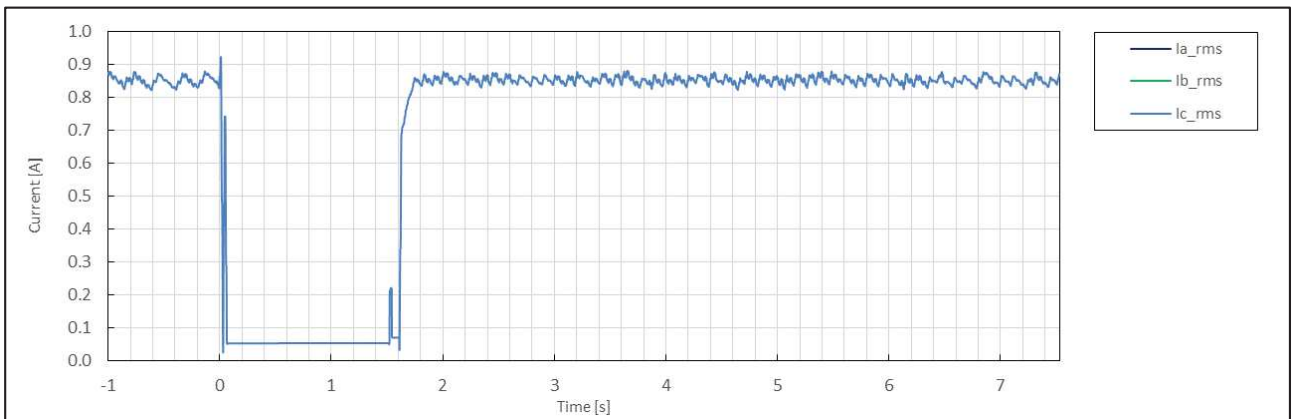
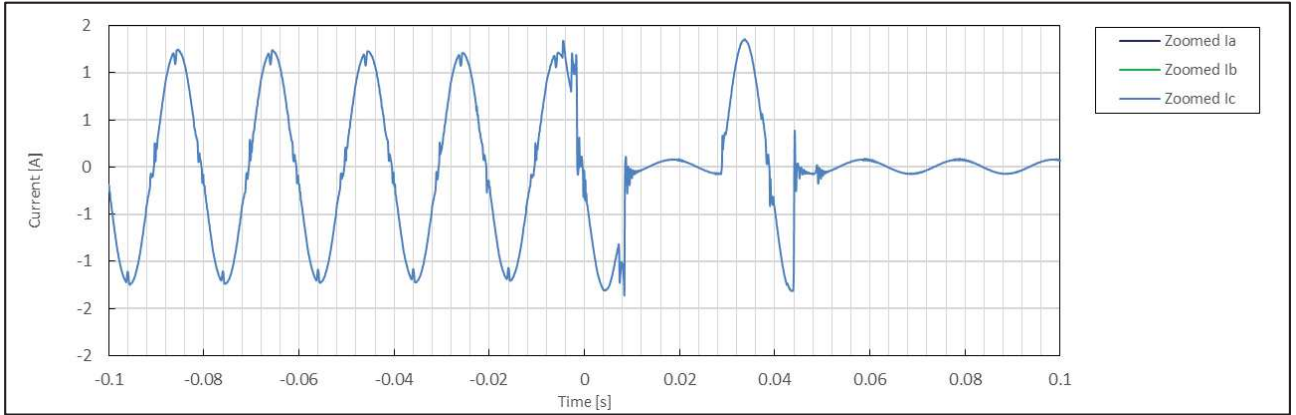

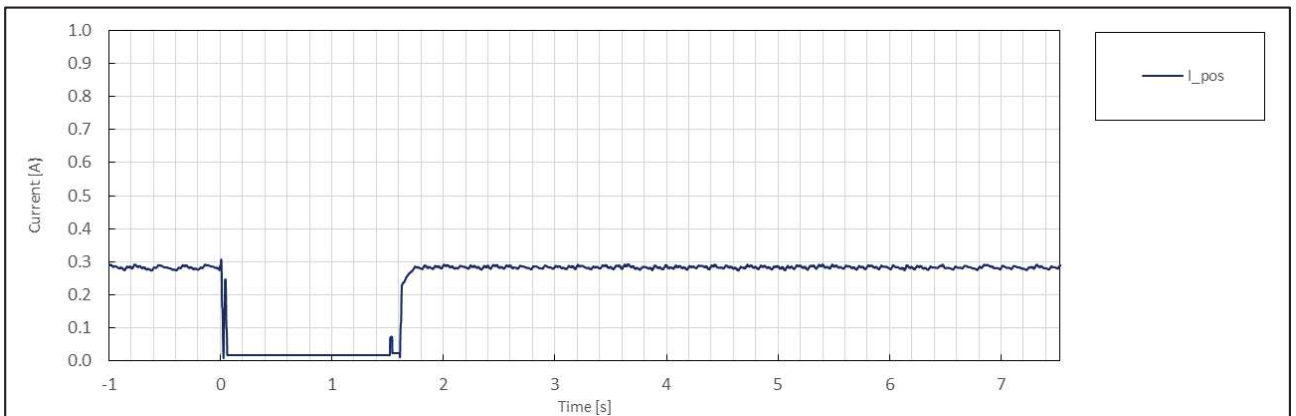
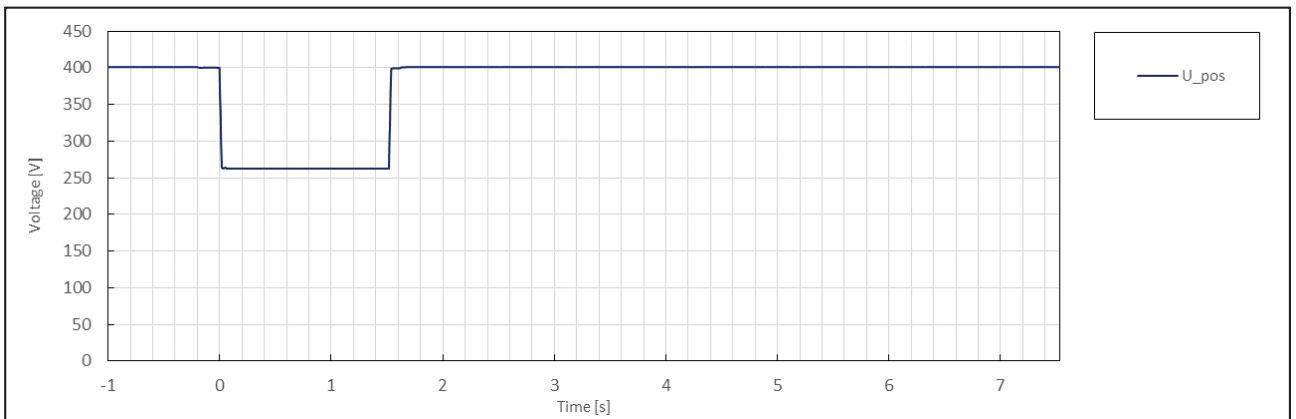
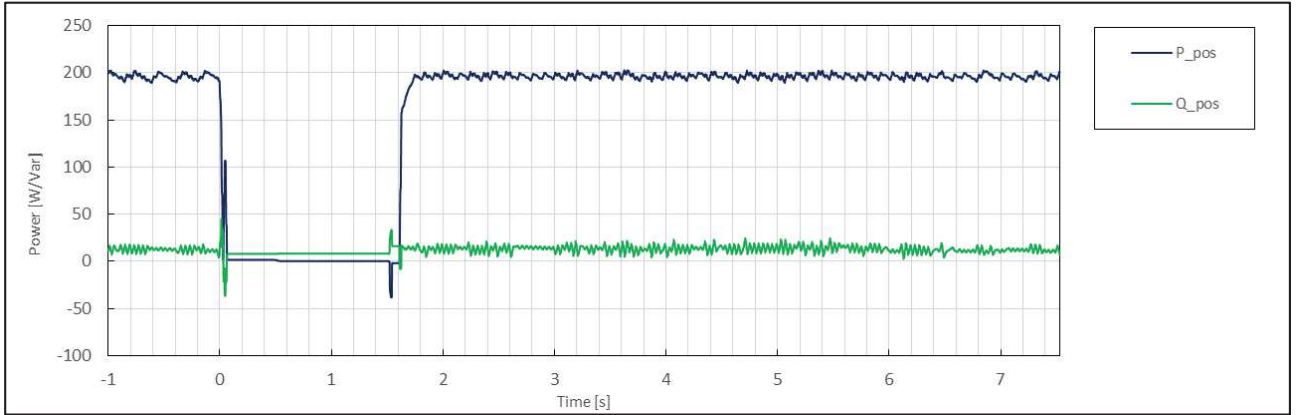

|                     | No. | Parameter  | Phase ref.      | Time ref.                       | unit       | Result        |
|---------------------|-----|--|-----------------|---------------------------------|------------|---------------|
| General Info.       | 0   | Test number  | --              | --                              | --         | 3.1           |
|                     | 1   | Date   | --              | --                              | dd.mm.yyyy | 3.1.2020      |
|                     | 2   | Time (start of test)                                   | --              | --                              | hh:mm:ss.f | 13:50:14      |
|                     | 3   | Fault type (phase)                                     | --              | --                              |            | 3-phase fault |
|                     | 4   | Setting voltage depth                                  | Line to line    | --                              | p.u.       | 0.50          |
|                     | 5   | Setting dip duration                                   |                 | --                              |            | 1535          |
|                     | 6   | Point of fault entry                                   | Total           | --                              | ms         | 0             |
|                     | 7   | Point of fault clearance                               | Total           | --                              | ms         | 1534          |
|                     | 8   | Fault duration in empty load test                      | Total           | --                              | ms         | 1535          |
|                     | 9   | Voltage depth/height in empty load test                | Total           | t1+100ms to t2 and t1-10s to t1 | p.u.       | 0.50          |
|                     | 10  |  | Pos.            |                                 | p.u.       | 0.50          |
| Before dip <t1      | 11  | Voltage  | Line to neutral | t1-100s to t1                   | p.u.       | 1.02          |
|                     | 12  | Current  | Pos.            | t1-500ms to t1-100ms            | p.u.       | 0.32          |
|                     | 13  | Active power   | Total           | t1-10s to t1                    | p.u.       | 1.01          |
|                     | 14  |  | Pos.            |                                 |            | 0.98          |
|                     | 15  | Reactive power   | Total           | t1-10s to t1                    | p.u.       | 0.05          |
|                     | 16  |  | Pos.            |                                 |            | 0.05          |
|                     | 17  | Cos $\varphi$  | --              | t1-10s to t1                    | --         | 0.999         |
| During dip t1 to t2 | 18  | Voltage  | Line to neutral | t1+100ms to t2-20ms             | p.u.       | 0.50          |
|                     | 19  | Line current   | Phase 1         | t1+60ms                         | p.u.       | N/A           |
|                     | 20  |  | Phase 2         |                                 |            | N/A           |
|                     | 21  |  | Phase 3         |                                 |            | 0.01          |
|                     | 22  | Line current   | Phase 1         | t1+100ms                        | p.u.       | N/A           |
|                     | 23  |  | Phase 2         |                                 |            | N/A           |
|                     | 24  |  | Phase 3         |                                 |            | 0.01          |
|                     | 25  | Active power   | Total           | t1+100ms to t2-20ms             | p.u.       | 0.00          |
|                     | 26  |  | Pos.            |                                 |            | 0.00          |
| After dip > t2      | 27  | Voltage  | Line to neutral | t2+3s to t2+10s                 | p.u.       | 1.02          |
|                     | 28  | Active power   | Total           | t2+3s to t2+10s                 | p.u.       | 1.01          |
|                     | 29  |  | Pos.            |                                 |            | 0.98          |
|                     | 39  | Active power rising time                               | Pos.            | --                              | s          | 0.530         |
|                     | 31  | Reactive power   | Total           | t2+3s to t2+10s                 | p.u.       | 0.05          |
|                     | 32  |  | Pos.            |                                 |            | 0.05          |
|                     | 33  | Reactive power rising time                             | Pos.            | --                              | s          | N/A           |
|                     | 34  | PGU does not disconnect from grid till 60s after fault | --              | t2 to t2+60s                    | Yes / No   | No            |

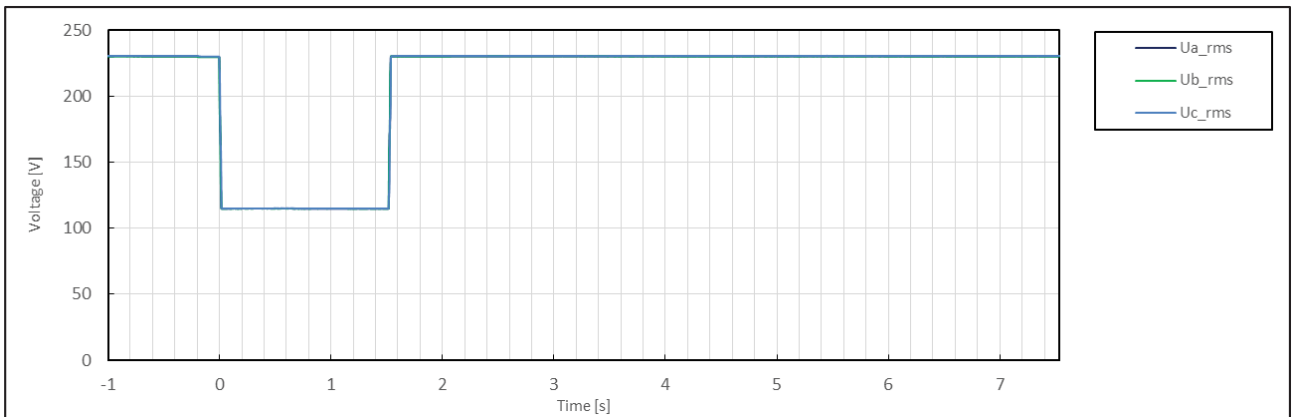
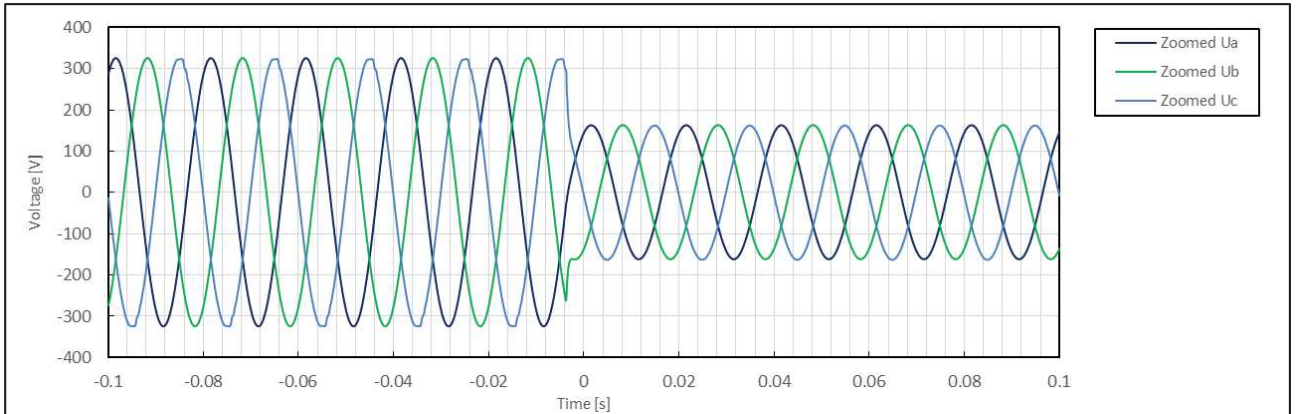
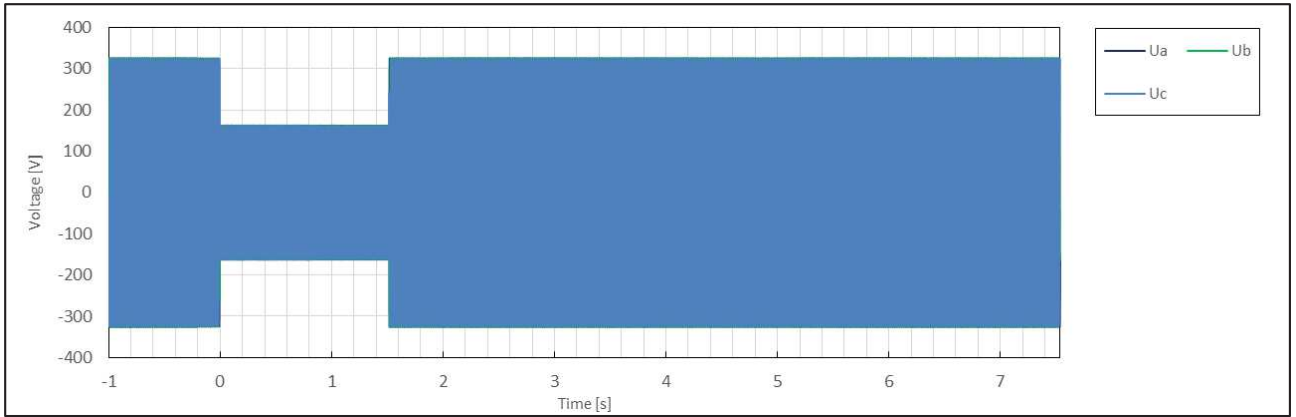

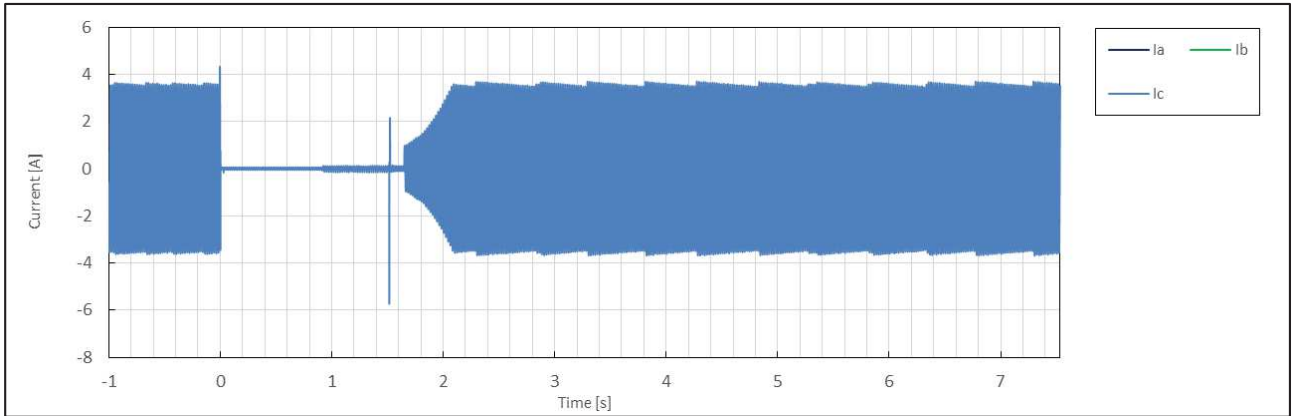
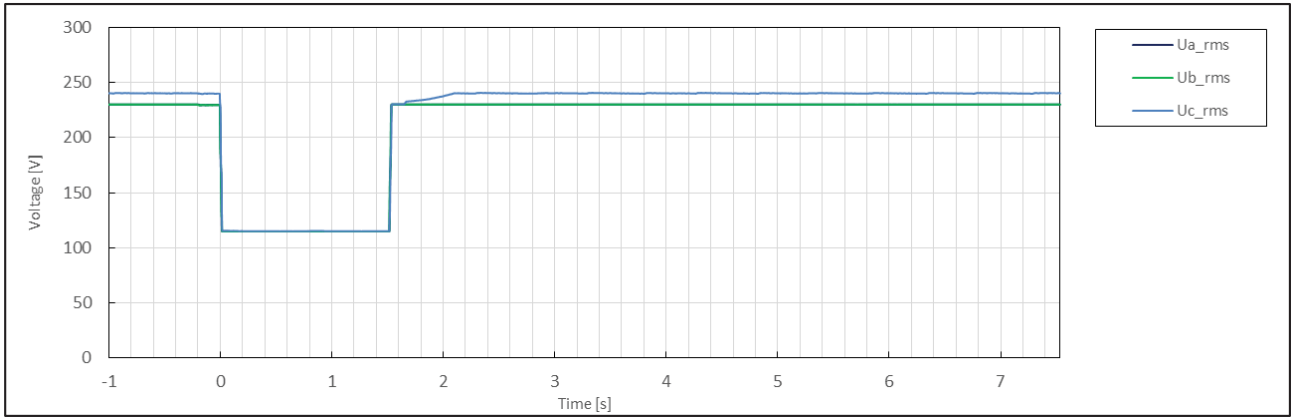
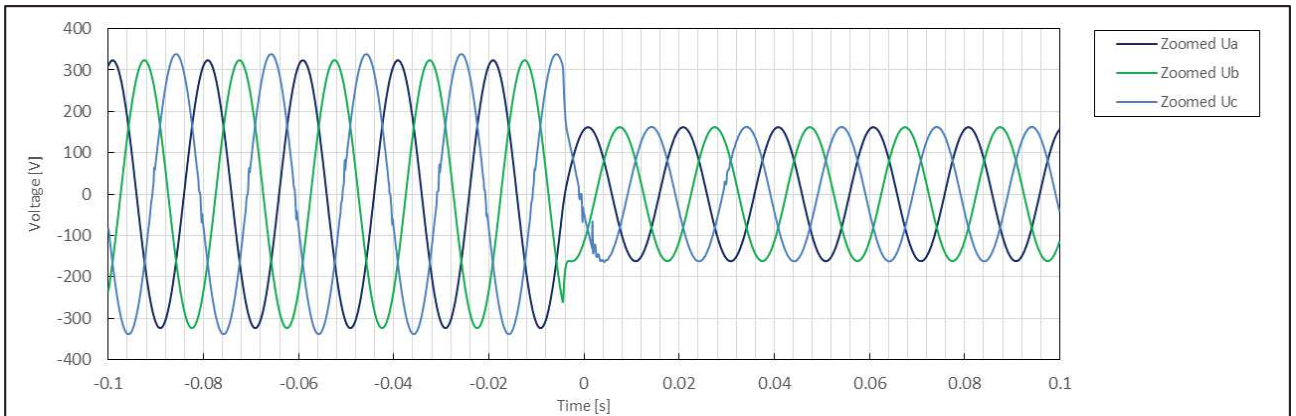
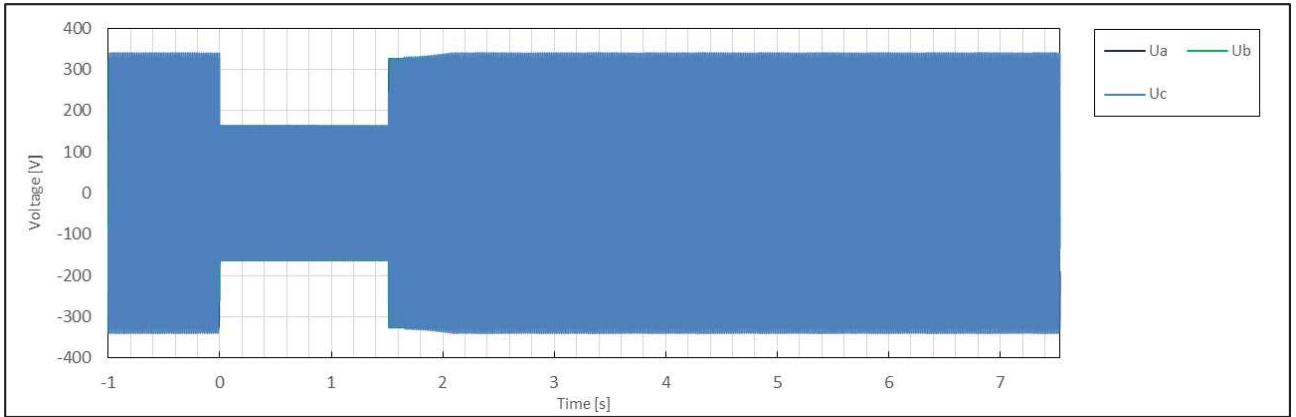

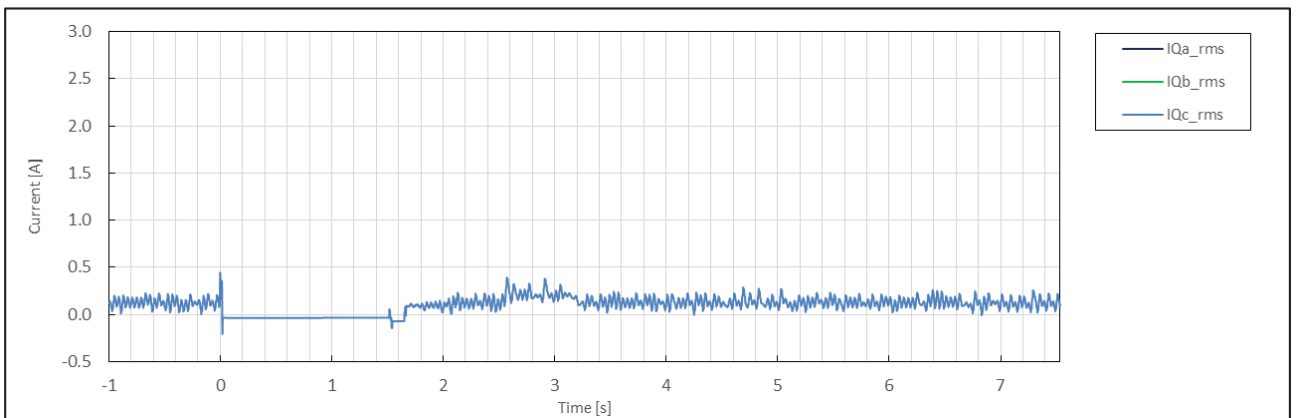
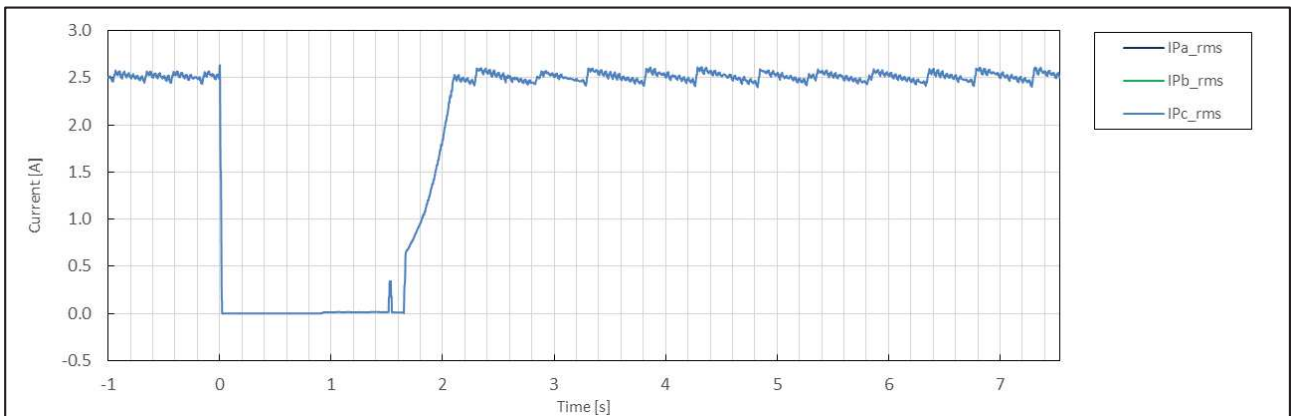
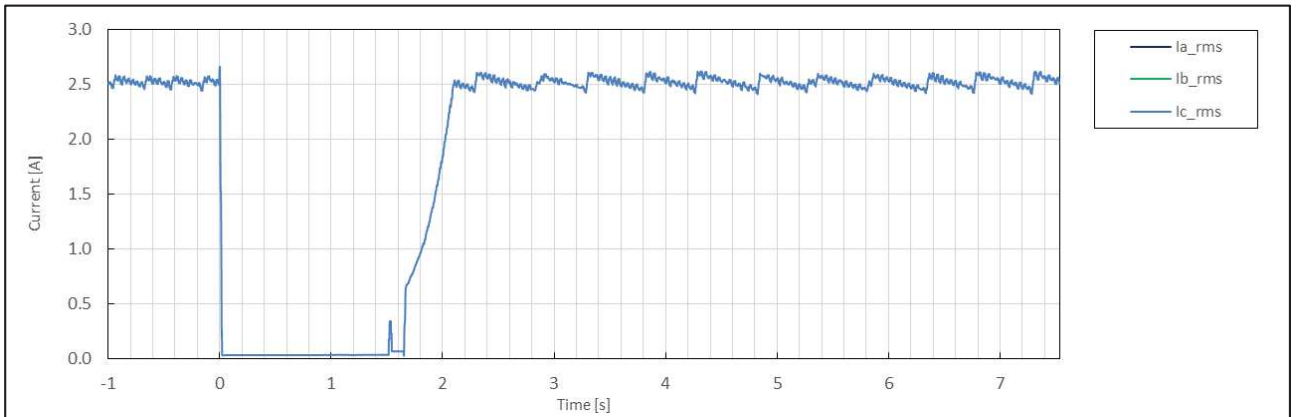
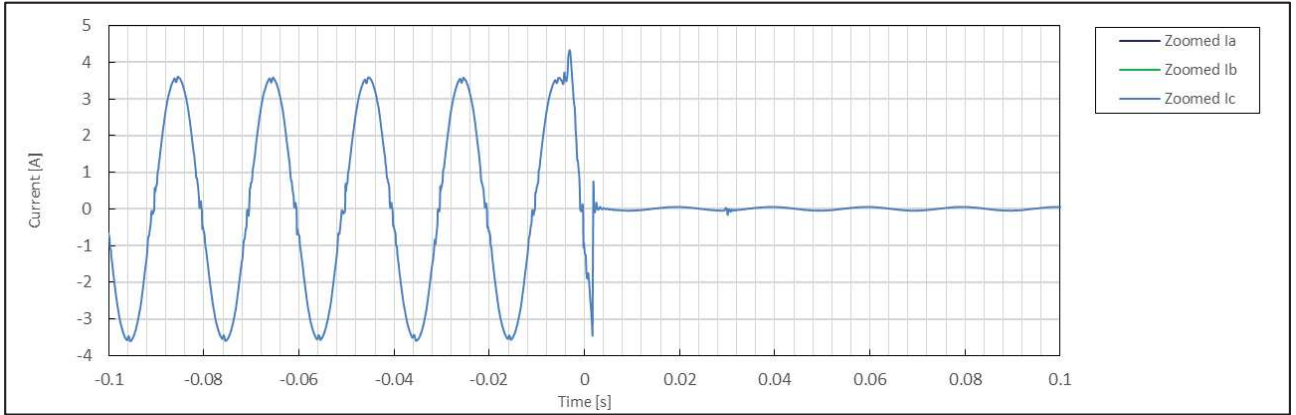

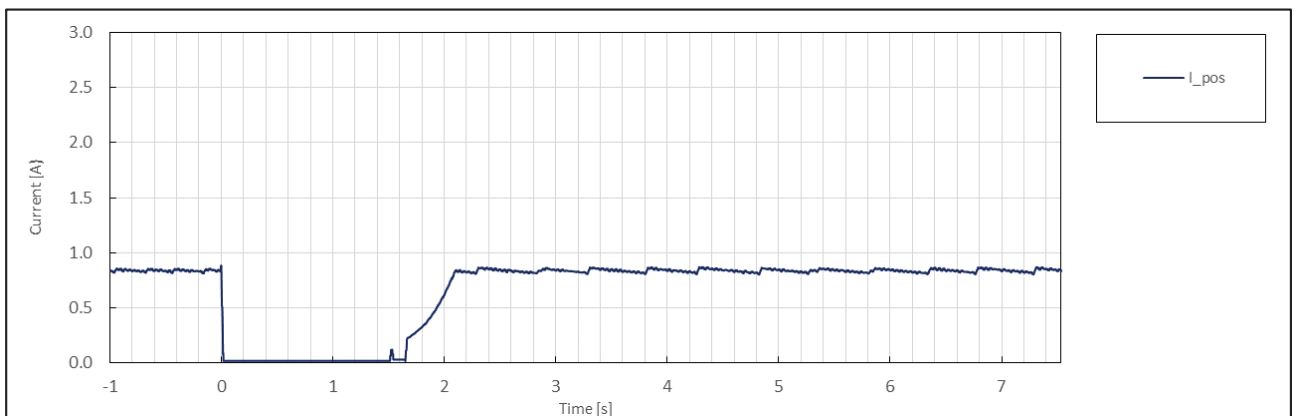
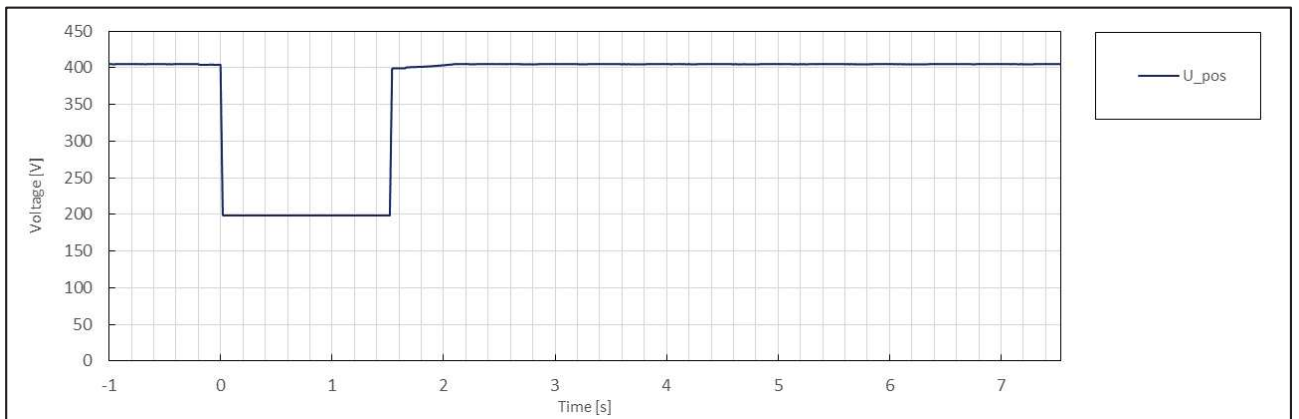
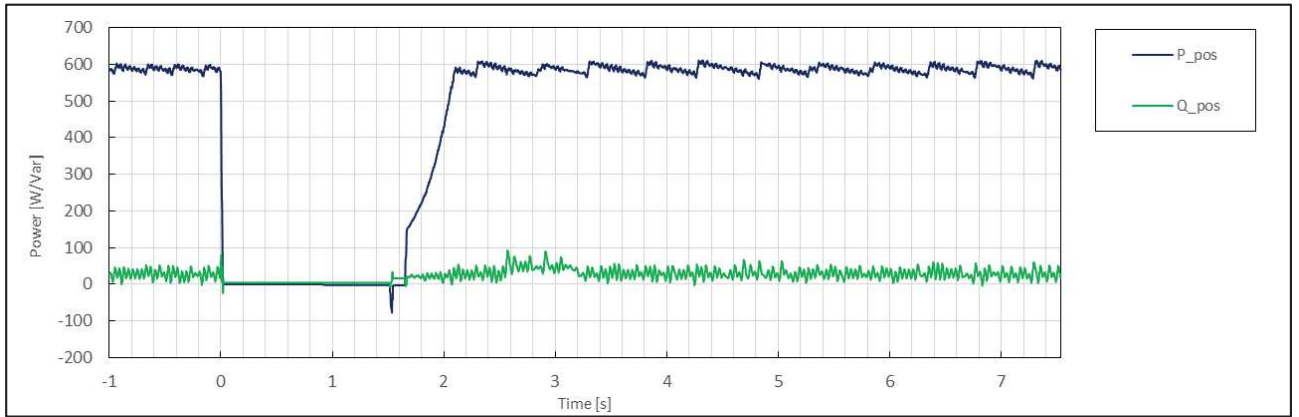

|                     | No. | Parameter  | Phase ref.      | Time ref.                       | unit       | Result        |
|---------------------|-----|--|-----------------|---------------------------------|------------|---------------|
| General Info.       | 0   | Test number  | --              | --                              | --         | 3.2           |
|                     | 1   | Date   | --              | --                              | dd.mm.yyyy | 3.1.2020      |
|                     | 2   | Time (start of test)                                   | --              | --                              | hh:mm:ss.f | 13:55:18      |
|                     | 3   | Fault type (phase)                                     | --              | --                              |            | 3-phase fault |
|                     | 4   | Setting voltage depth                                  | Line to line    | --                              | p.u.       | 0.50          |
|                     | 5   | Setting dip duration                                   |                 | --                              |            | 1535          |
|                     | 6   | Point of fault entry                                   | Total           | --                              | ms         | 0             |
|                     | 7   | Point of fault clearance                               | Total           | --                              | ms         | 1534          |
|                     | 8   | Fault duration in empty load test                      | Total           | --                              | ms         | 1535          |
|                     | 9   | Voltage depth/height in empty load test                | Total           | t1+100ms to t2 and t1-10s to t1 | p.u.       | 0.50          |
|                     | 10  |  | Pos.            |                                 | p.u.       | 0.50          |
| Before dip <t1      | 11  | Voltage  | Line to neutral | t1-100s to t1                   | p.u.       | 1.01          |
|                     | 12  | Current  | Pos.            | t1-500ms to t1-100ms            | p.u.       | 0.11          |
|                     | 13  | Active power   | Total           | t1-10s to t1                    | p.u.       | 0.33          |
|                     | 14  |  | Pos.            |                                 |            | 0.32          |
|                     | 15  | Reactive power   | Total           | t1-10s to t1                    | p.u.       | 0.04          |
|                     | 16  |  | Pos.            |                                 |            | 0.04          |
|                     | 17  | Cos $\varphi$  | --              | t1-10s to t1                    | --         | 0.994         |
| During dip t1 to t2 | 18  | Voltage  | Line to neutral | t1+100ms to t2-20ms             | p.u.       | 0.50          |
|                     | 19  | Line current   | Phase 1         | t1+60ms                         | p.u.       | N/A           |
|                     | 20  |  | Phase 2         |                                 |            | N/A           |
|                     | 21  |  | Phase 3         |                                 |            | 0.01          |
|                     | 22  | Line current   | Phase 1         | t1+100ms                        | p.u.       | N/A           |
|                     | 23  |  | Phase 2         |                                 |            | N/A           |
|                     | 24  |  | Phase 3         |                                 |            | 0.01          |
|                     | 25  | Active power   | Total           | t1+100ms to t2-20ms             | p.u.       | 0.00          |
|                     | 26  |  | Pos.            |                                 |            | 0.00          |
| After dip > t2      | 27  | Voltage  | Line to neutral | t2+3s to t2+10s                 | p.u.       | 1.01          |
|                     | 28  | Active power   | Total           | t2+3s to t2+10s                 | p.u.       | 0.33          |
|                     | 29  |  | Pos.            |                                 |            | 0.33          |
|                     | 39  | Active power rising time                               | Pos.            | --                              | s          | 0.151         |
|                     | 31  | Reactive power   | Total           | t2+3s to t2+10s                 | p.u.       | 0.04          |
|                     | 32  |  | Pos.            |                                 |            | 0.04          |
|                     | 33  | Reactive power rising time                             | Pos.            | --                              | s          | N/A           |
|                     | 34  | PGU does not disconnect from grid till 60s after fault | --              | t2 to t2+60s                    | Yes / No   | No            |



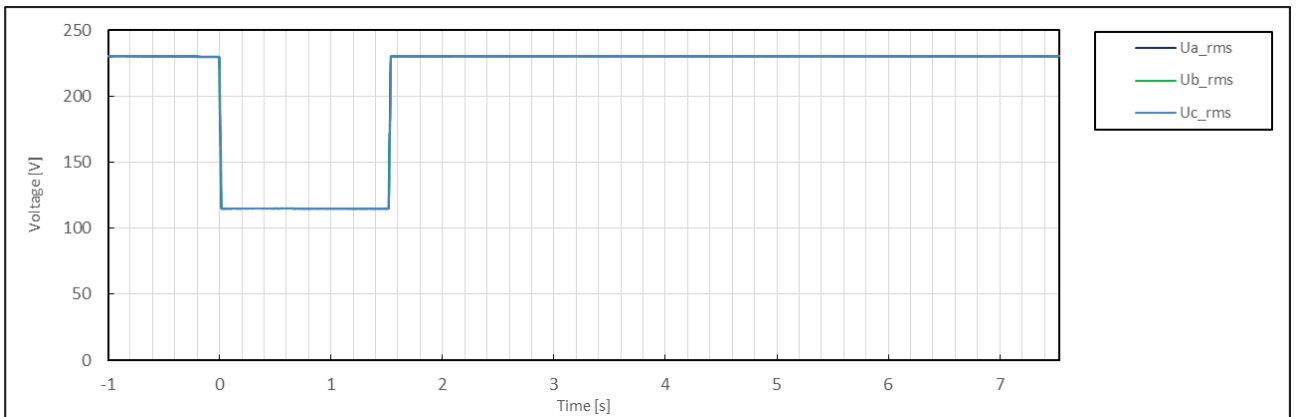
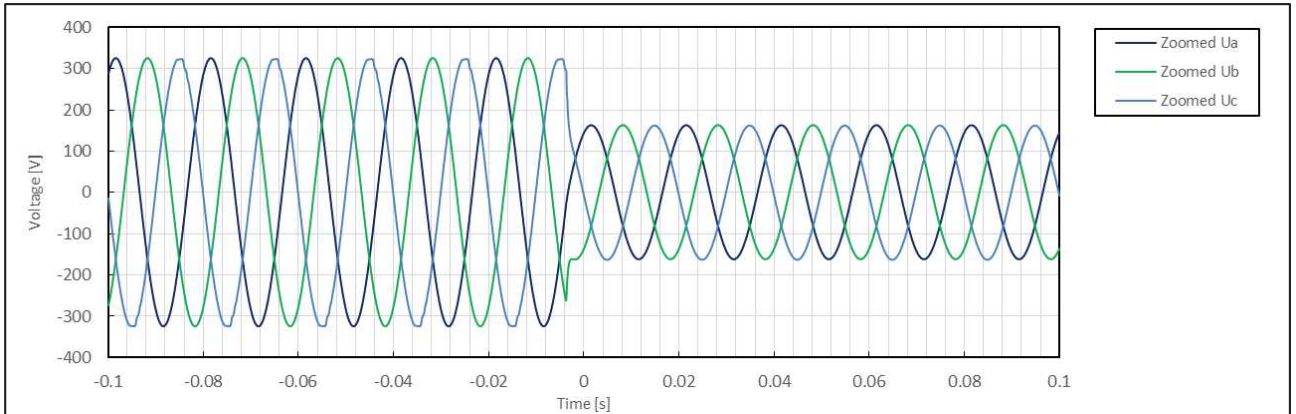
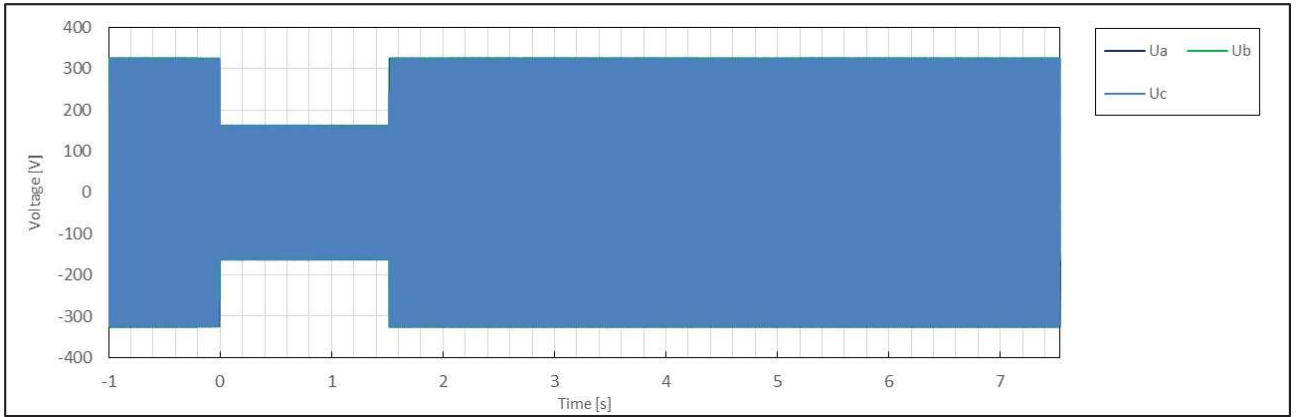

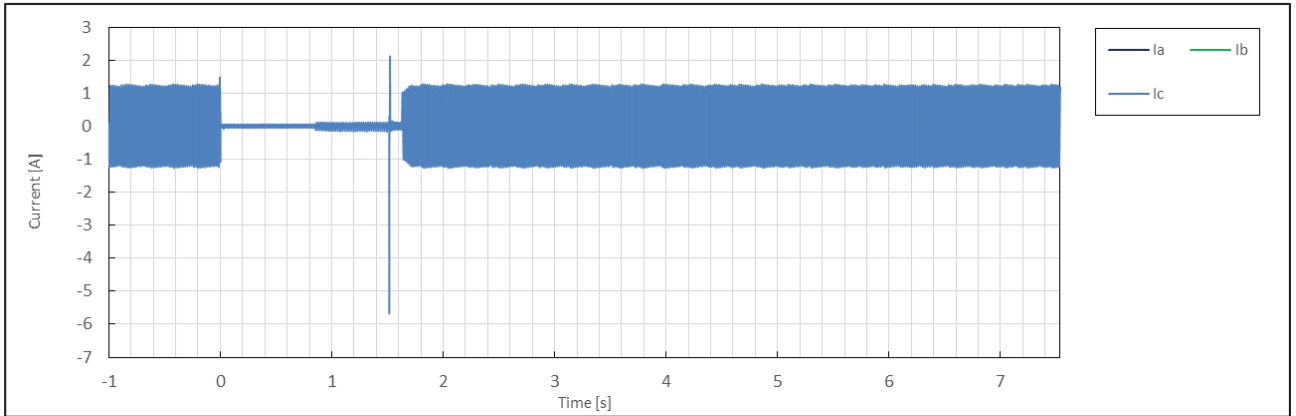
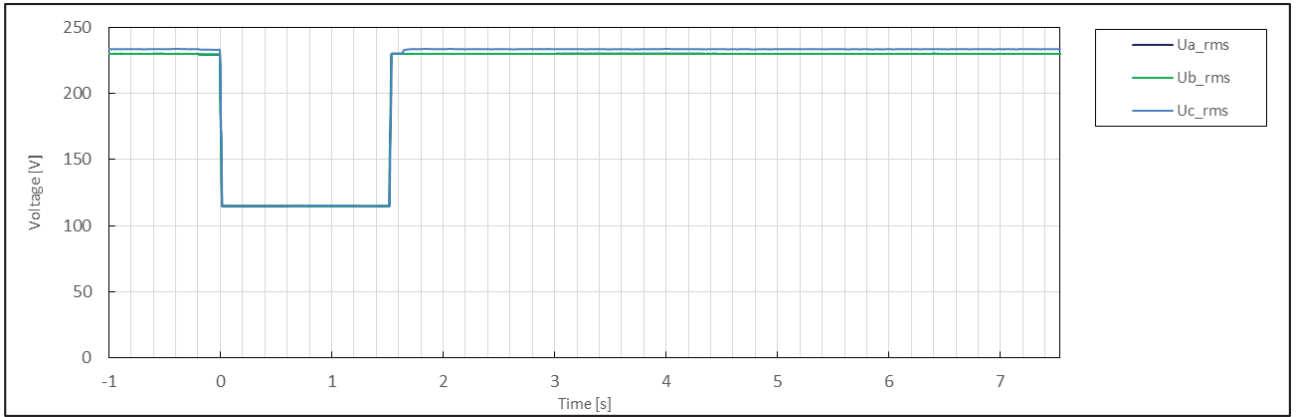
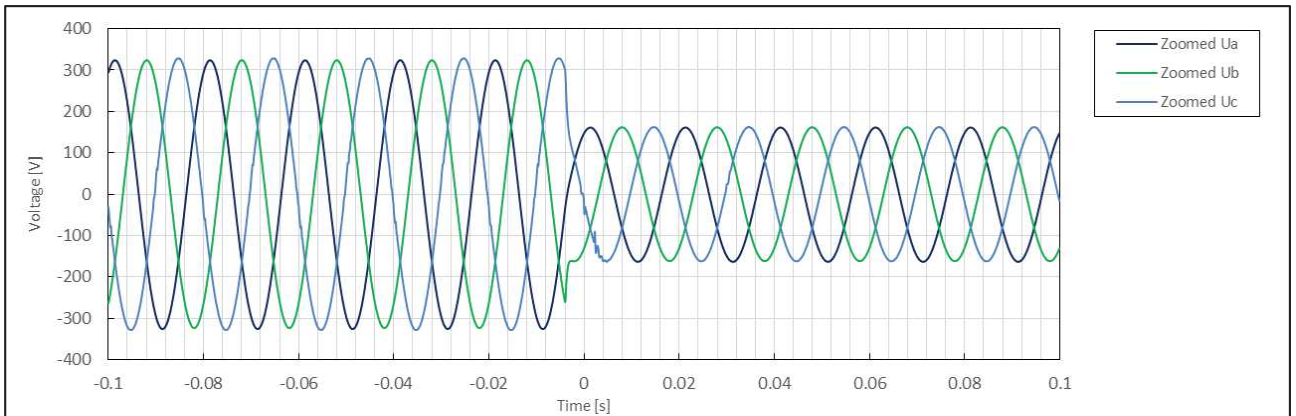
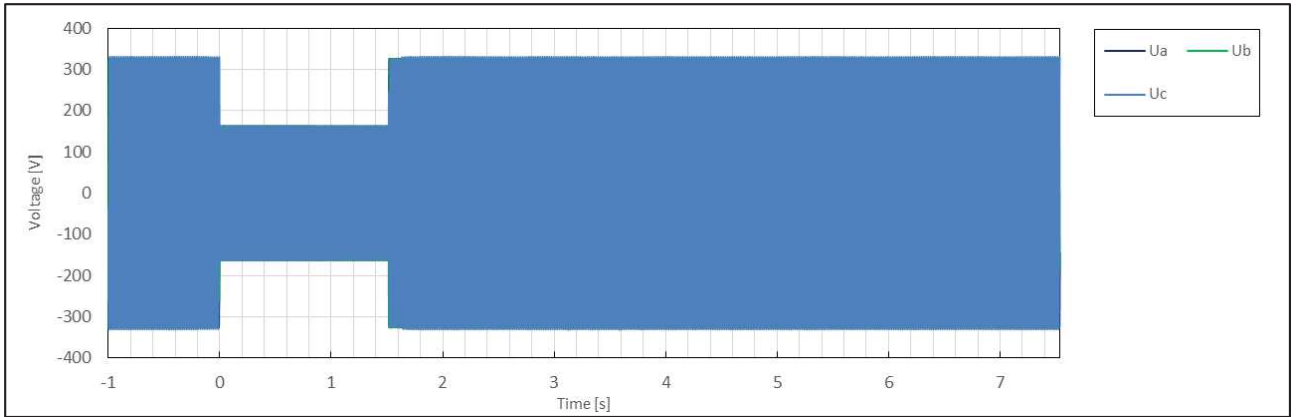

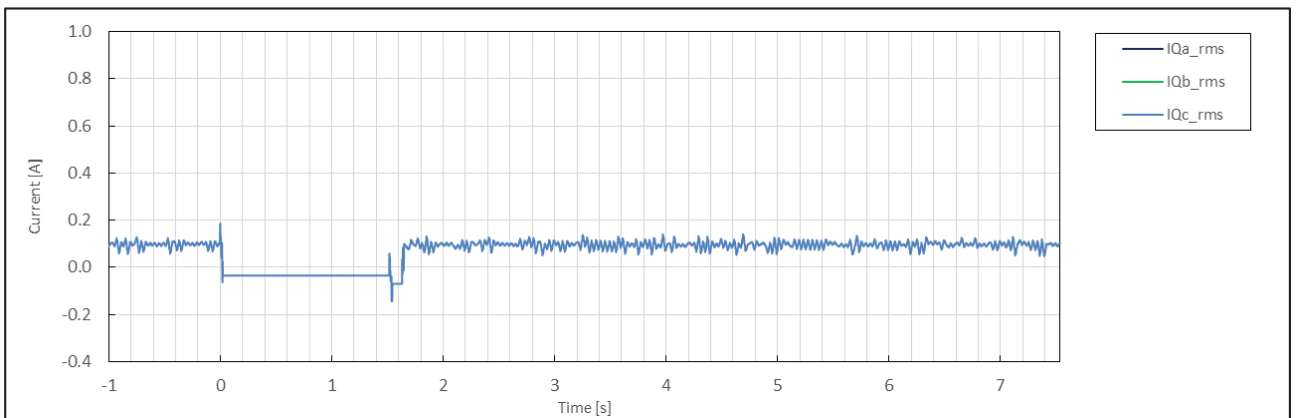
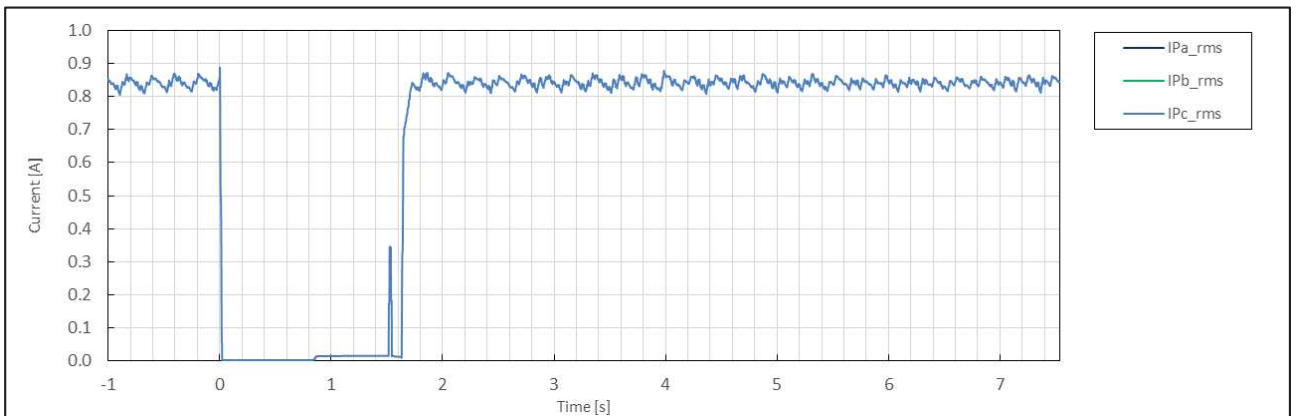
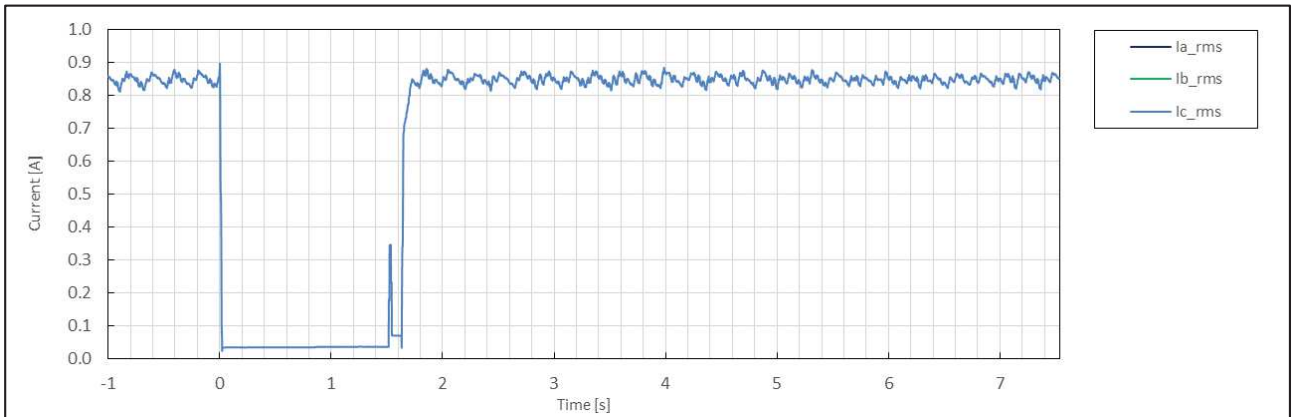
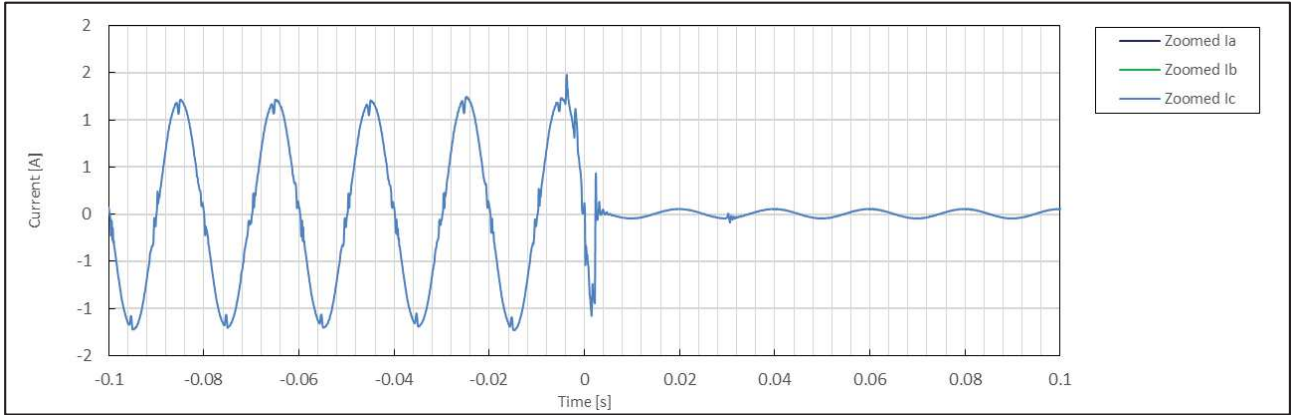

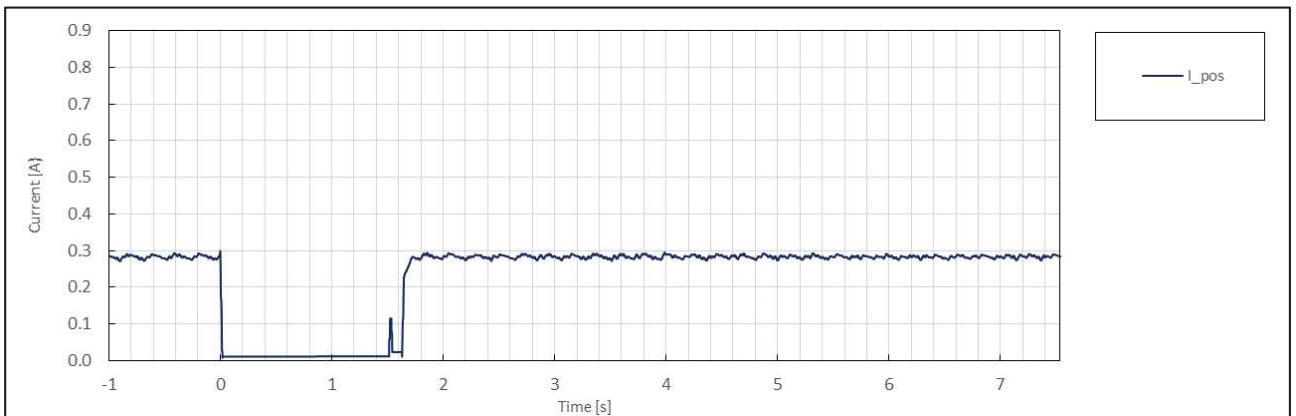
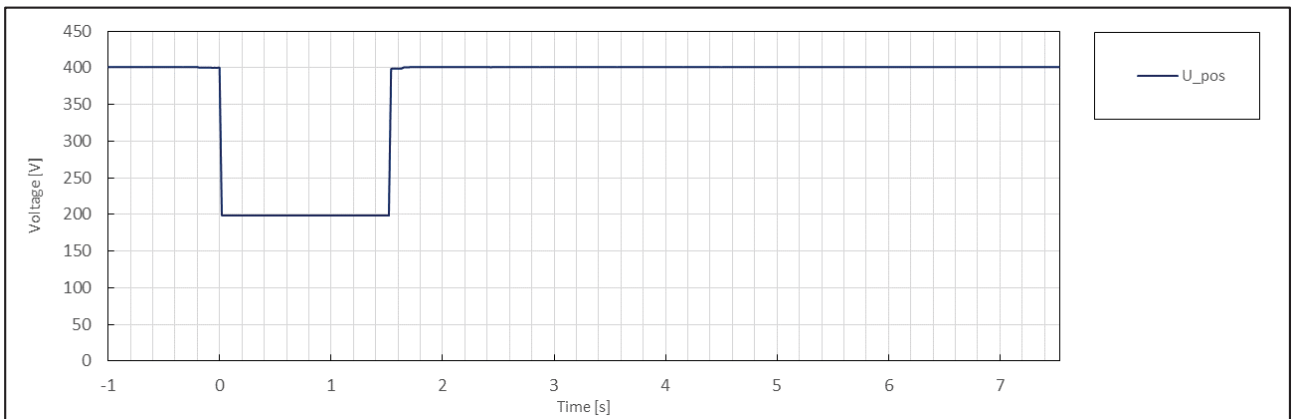
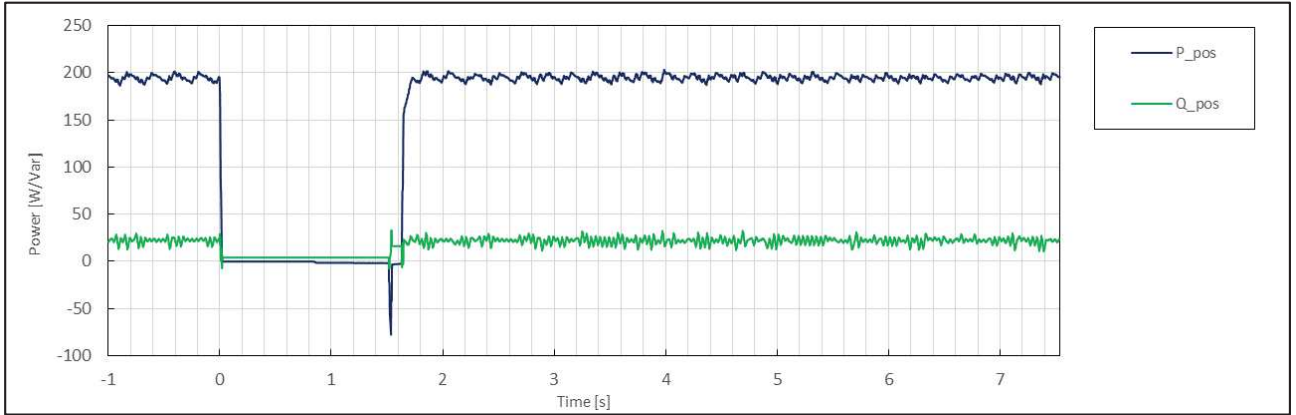

|                     | No. | Parameter  | Phase ref.      | Time ref.                       | unit       | Result        |
|---------------------|-----|--|-----------------|---------------------------------|------------|---------------|
| General Info.       | 0   | Test number  | --              | --                              | --         | 3.3           |
|                     | 1   | Date   | --              | --                              | dd.mm.yyyy | 3.1.2020      |
|                     | 2   | Time (start of test)                                   | --              | --                              | hh:mm:ss.f | 14:01:36      |
|                     | 3   | Fault type (phase)                                     | --              | --                              |            | 2-phase fault |
|                     | 4   | Setting voltage depth                                  | Line to line    | --                              | p.u.       | 0.50          |
|                     | 5   | Setting dip duration                                   |                 | --                              |            | 1530          |
|                     | 6   | Point of fault entry                                   | Total           | --                              | ms         | 0             |
|                     | 7   | Point of fault clearance                               | Total           | --                              | ms         | 1529          |
|                     | 8   | Fault duration in empty load test                      | Total           | --                              | ms         | 1530          |
|                     | 9   | Voltage depth/height in empty load test                | Total           | t1+100ms to t2 and t1-10s to t1 | p.u.       | 0.76          |
|                     | 10  |  | Pos.            |                                 | p.u.       | 0.66          |
| Before dip <t1      | 11  | Voltage  | Line to neutral | t1-100s to t1                   | p.u.       | 1.02          |
|                     | 12  | Current  | Pos.            | t1-500ms to t1-100ms            | p.u.       | 0.32          |
|                     | 13  | Active power   | Total           | t1-10s to t1                    | p.u.       | 0.92          |
|                     | 14  |  | Pos.            |                                 |            | 0.92          |
|                     | 15  | Reactive power   | Total           | t1-10s to t1                    | p.u.       | 0.03          |
|                     | 16  |  | Pos.            |                                 |            | 0.03          |
|                     | 17  | Cos $\varphi$  | --              | t1-10s to t1                    | --         | 0.997         |
| During dip t1 to t2 | 18  | Voltage  | Line to neutral | t1+100ms to t2-20ms             | p.u.       | 0.76          |
|                     | 19  | Line current   | Phase 1         | t1+60ms                         | p.u.       | N/A           |
|                     | 20  |  | Phase 2         |                                 |            | N/A           |
|                     | 21  |  | Phase 3         |                                 |            | 0.01          |
|                     | 22  | Line current   | Phase 1         | t1+100ms                        | p.u.       | N/A           |
|                     | 23  |  | Phase 2         |                                 |            | N/A           |
|                     | 24  |  | Phase 3         |                                 |            | 0.01          |
|                     | 25  | Active power   | Total           | t1+100ms to t2-20ms             | p.u.       | 0.00          |
|                     | 26  |  | Pos.            |                                 |            | 0.00          |
| After dip > t2      | 27  | Voltage  | Line to neutral | t2+3s to t2+10s                 | p.u.       | 1.00          |
|                     | 28  | Active power   | Total           | t2+3s to t2+10s                 | p.u.       | 0.92          |
|                     | 29  |  | Pos.            |                                 |            | 0.92          |
|                     | 39  | Active power rising time                               | Pos.            | --                              | s          | 0.684         |
|                     | 31  | Reactive power   | Total           | t2+3s to t2+10s                 | p.u.       | 0.03          |
|                     | 32  |  | Pos.            |                                 |            | 0.03          |
|                     | 33  | Reactive power rising time                             | Pos.            | --                              | s          | N/A           |
|                     | 34  | PGU does not disconnect from grid till 60s after fault | --              | t2 to t2+60s                    | Yes / No   | No            |

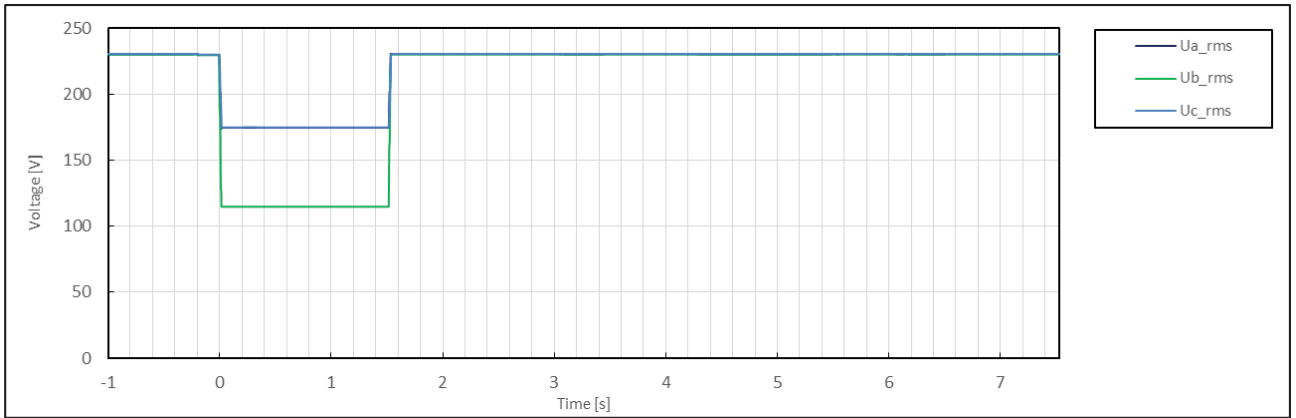
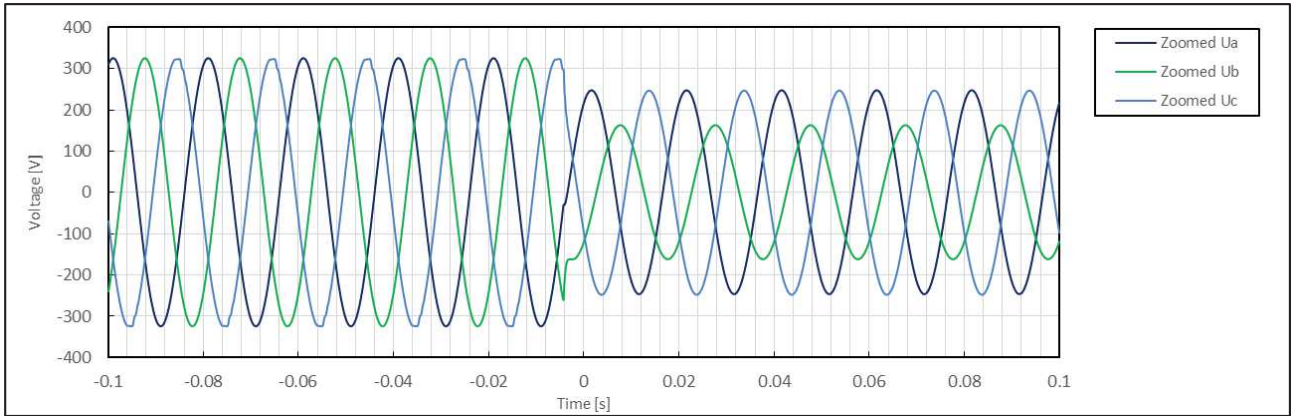
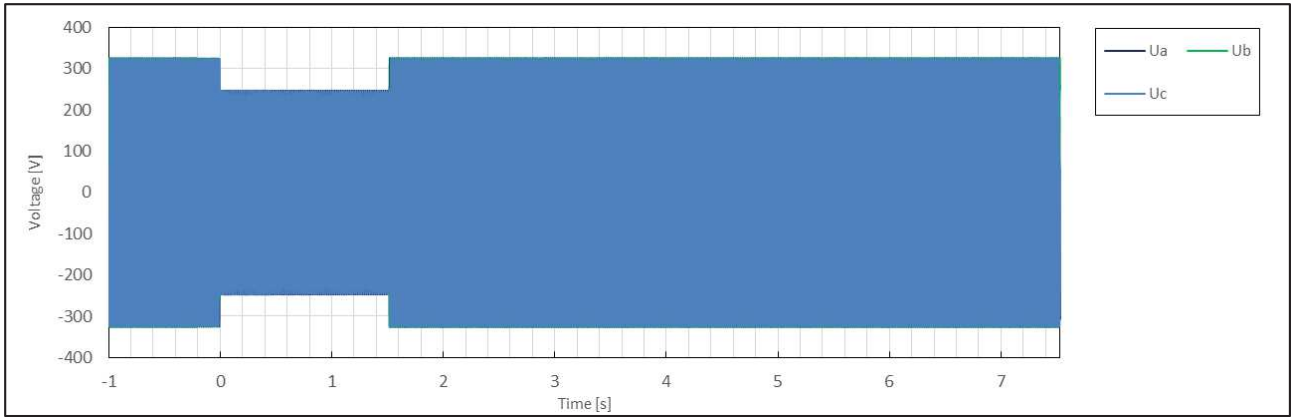

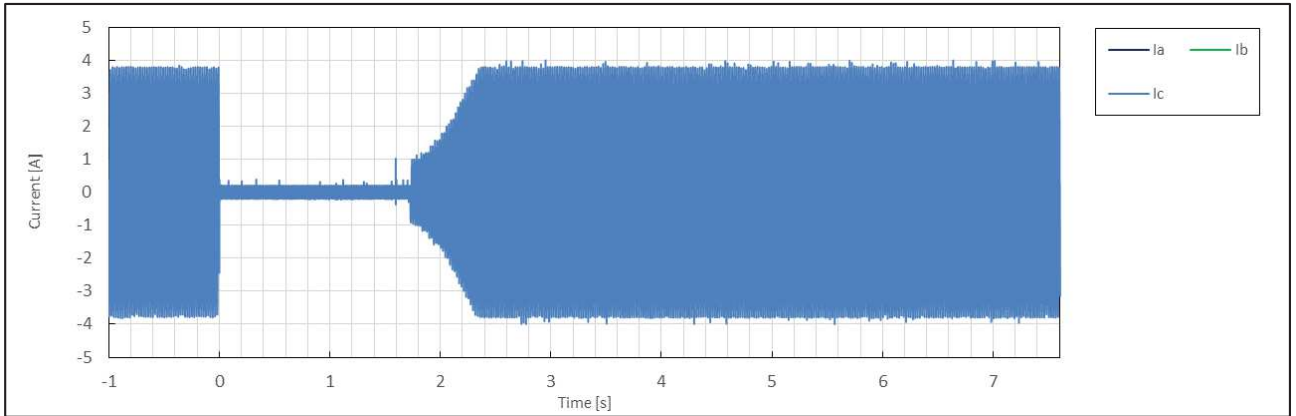
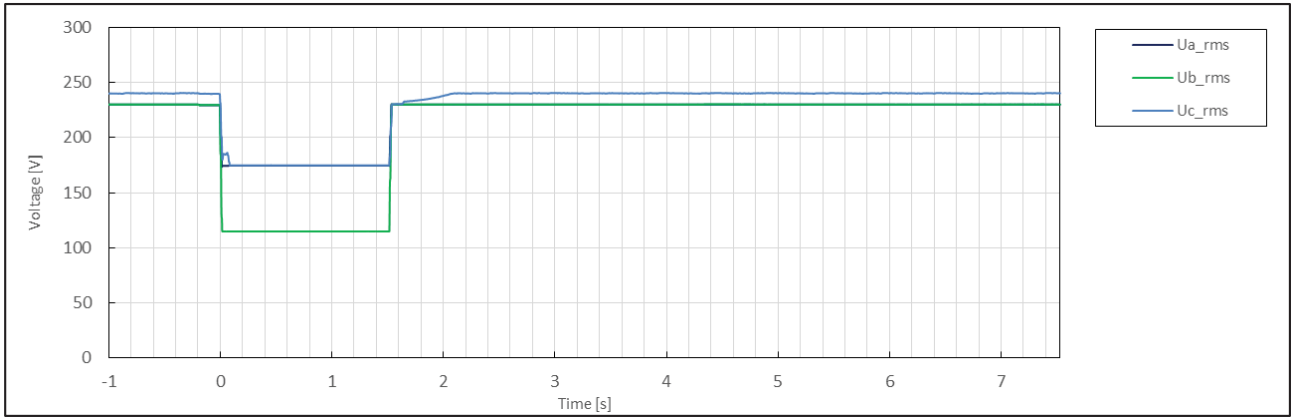
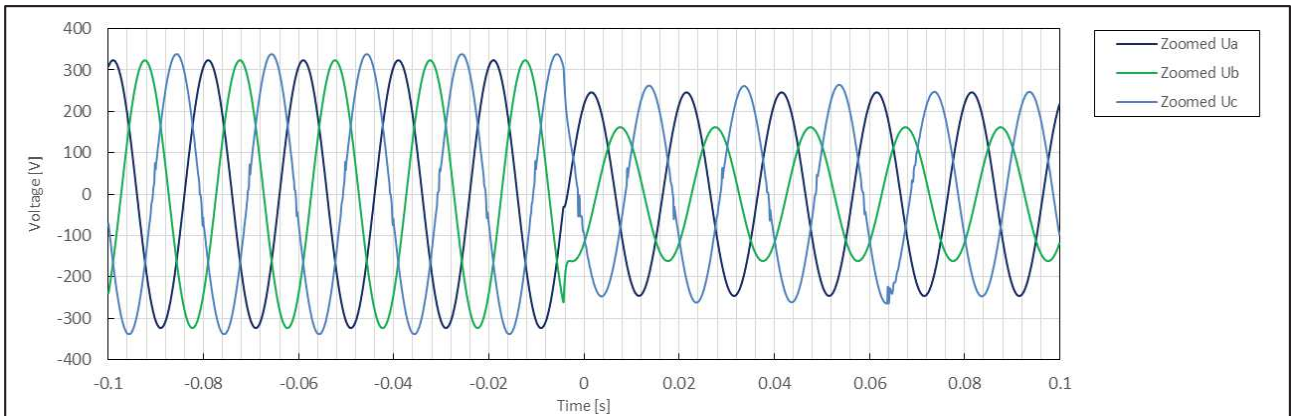
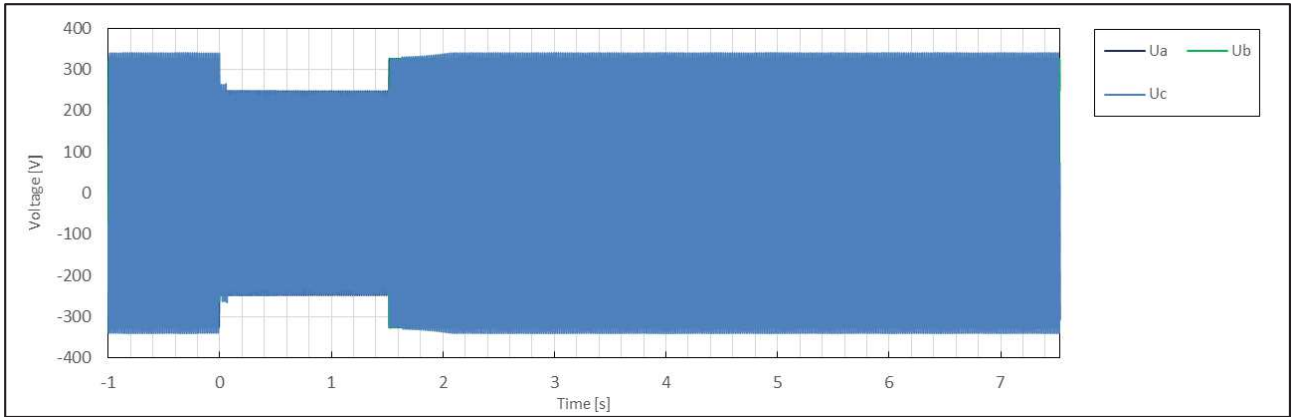



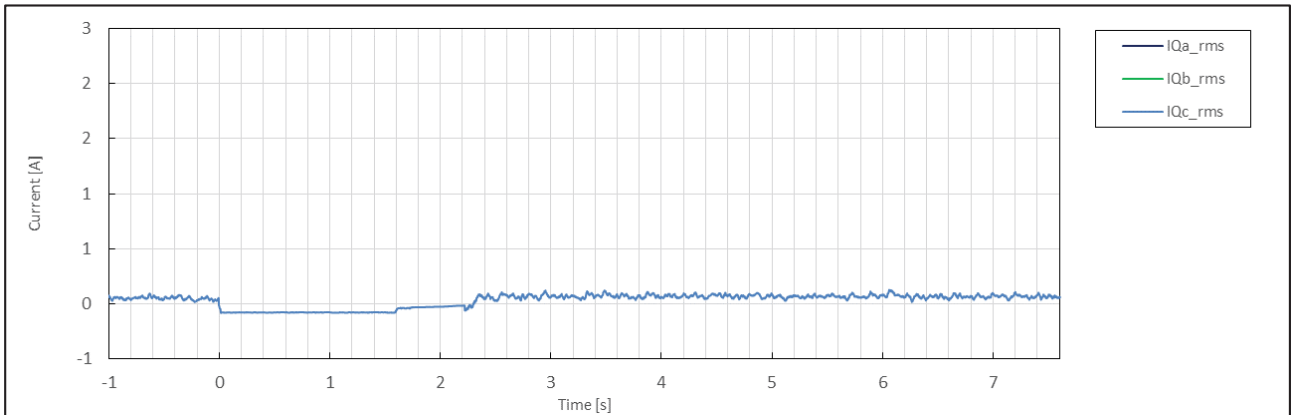
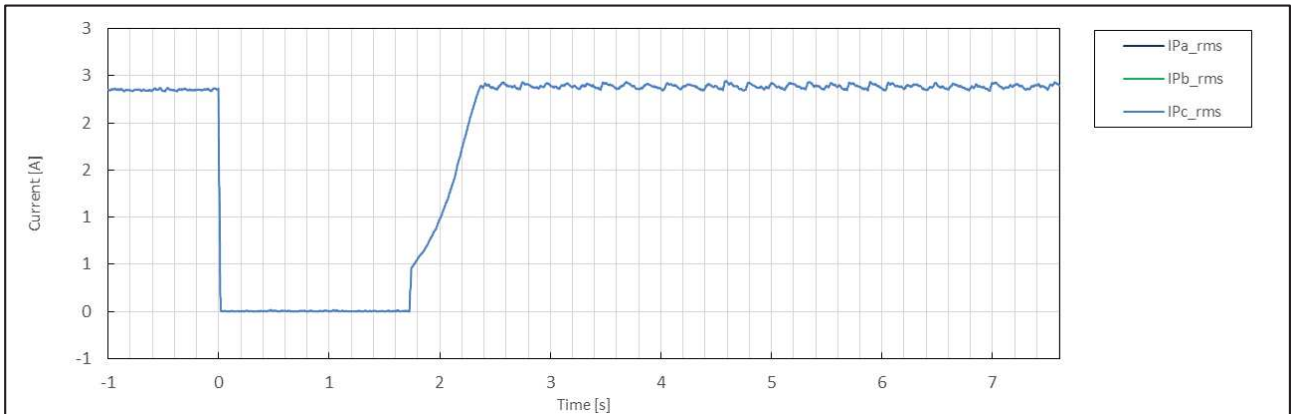
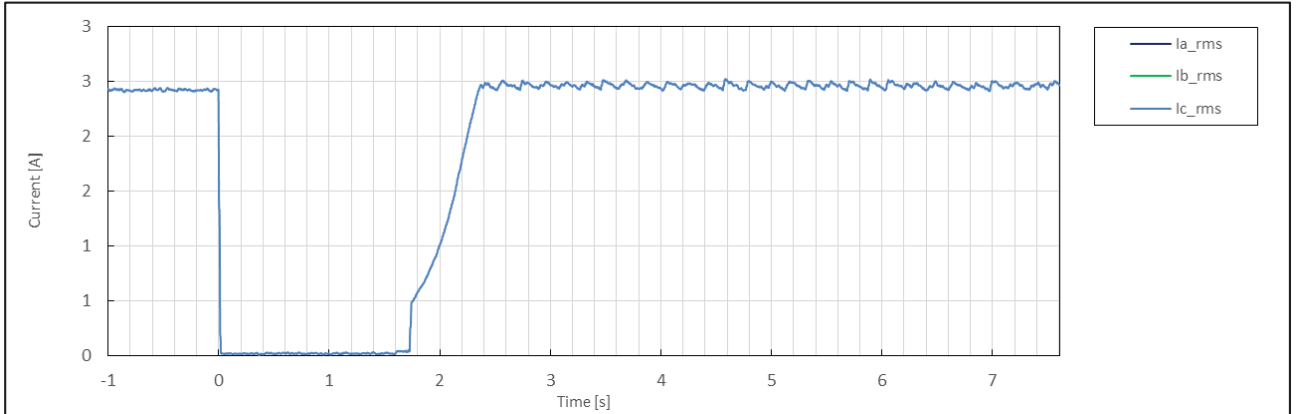
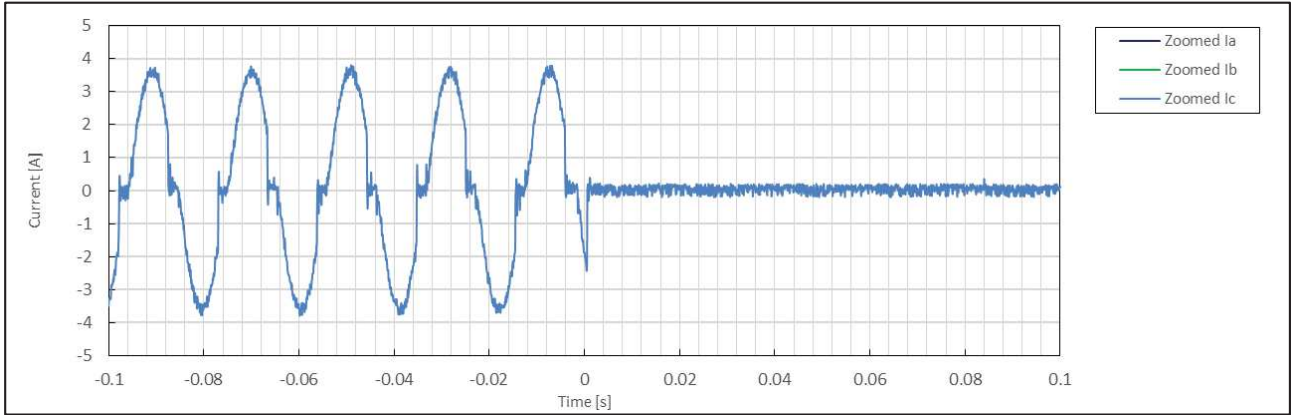



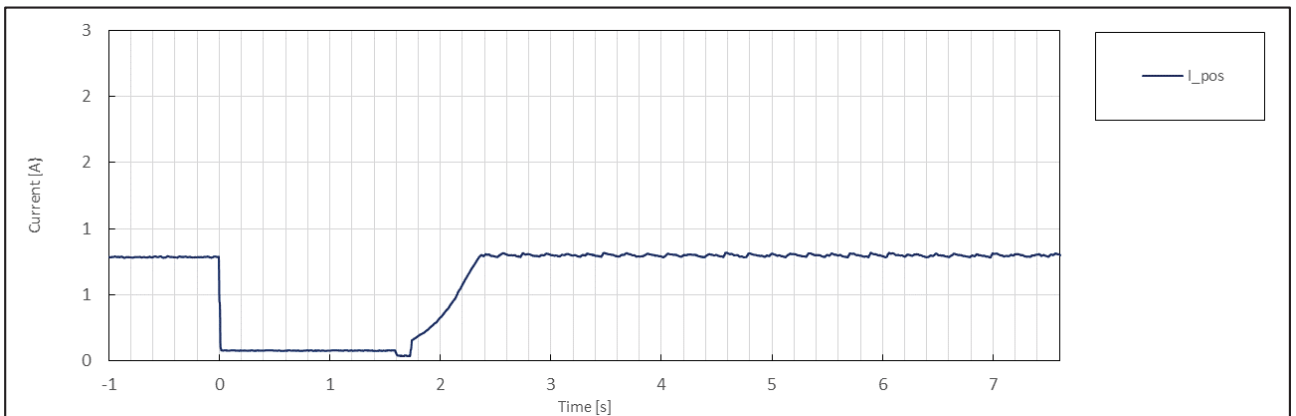
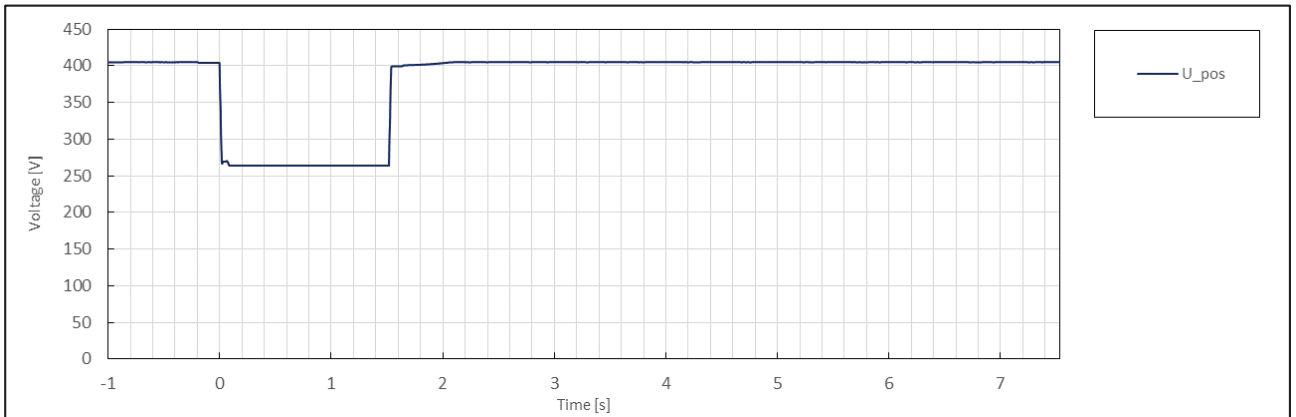
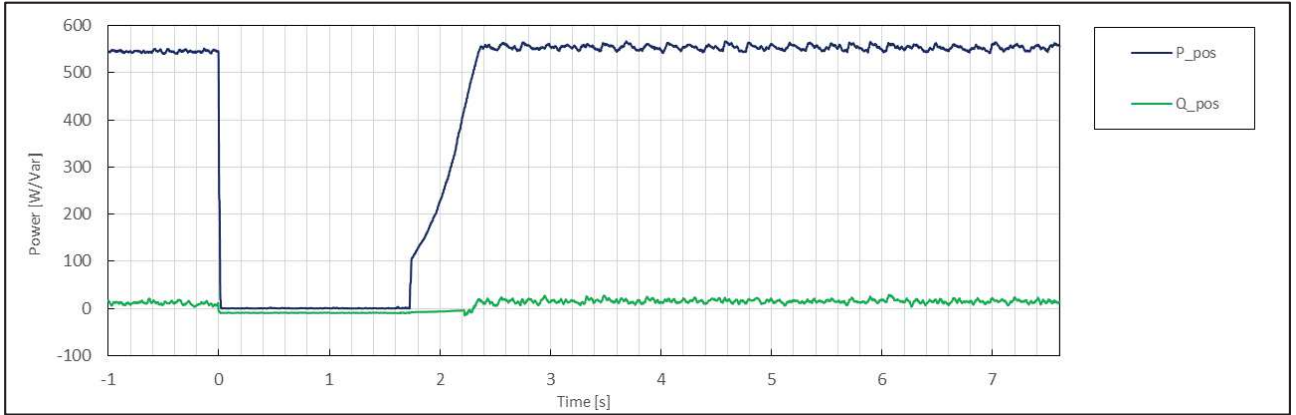

|                     | No. | Parameter  | Phase ref.      | Time ref.                       | unit       | Result        |
|---------------------|-----|--|-----------------|---------------------------------|------------|---------------|
| General Info.       | 0   | Test number  | --              | --                              | --         | 3.4           |
|                     | 1   | Date   | --              | --                              | dd.mm.yyyy | 3.1.2020      |
|                     | 2   | Time (start of test)                                   | --              | --                              | hh:mm:ss.f | 14:05:49      |
|                     | 3   | Fault type (phase)                                     | --              | --                              |            | 2-phase fault |
|                     | 4   | Setting voltage depth                                  | Line to line    | --                              | p.u.       | 0.50          |
|                     | 5   | Setting dip duration                                   |                 | --                              |            | 1530          |
|                     | 6   | Point of fault entry                                   | Total           | --                              | ms         | 0             |
|                     | 7   | Point of fault clearance                               | Total           | --                              | ms         | 1529          |
|                     | 8   | Fault duration in empty load test                      | Total           | --                              | ms         | 1530          |
|                     | 9   | Voltage depth/height in empty load test                | Total           | t1+100ms to t2 and t1-10s to t1 | p.u.       | 0.76          |
|                     | 10  |  | Pos.            |                                 | p.u.       | 0.66          |
| Before dip <t1      | 11  | Voltage  | Line to neutral | t1-100s to t1                   | p.u.       | 1.01          |
|                     | 12  | Current  | Pos.            | t1-500ms to t1-100ms            | p.u.       | 0.11          |
|                     | 13  | Active power   | Total           | t1-10s to t1                    | p.u.       | 0.33          |
|                     | 14  |  | Pos.            |                                 |            | 0.33          |
|                     | 15  | Reactive power   | Total           | t1-10s to t1                    | p.u.       | 0.04          |
|                     | 16  |  | Pos.            |                                 |            | 0.04          |
|                     | 17  | Cos $\varphi$  | --              | t1-10s to t1                    | --         | 0.994         |
| During dip t1 to t2 | 18  | Voltage  | Line to neutral | t1+100ms to t2-20ms             | p.u.       | 0.76          |
|                     | 19  | Line current   | Phase 1         | t1+60ms                         | p.u.       | N/A           |
|                     | 20  |  | Phase 2         |                                 |            | N/A           |
|                     | 21  |  | Phase 3         |                                 |            | 0.10          |
|                     | 22  | Line current   | Phase 1         | t1+100ms                        | p.u.       | N/A           |
|                     | 23  |  | Phase 2         |                                 |            | N/A           |
|                     | 24  |  | Phase 3         |                                 |            | 0.02          |
|                     | 25  | Active power   | Total           | t1+100ms to t2-20ms             | p.u.       | 0.00          |
|                     | 26  |  | Pos.            |                                 |            | 0.00          |
| After dip > t2      | 27  | Voltage  | Line to neutral | t2+3s to t2+10s                 | p.u.       | 1.01          |
|                     | 28  | Active power   | Total           | t2+3s to t2+10s                 | p.u.       | 0.33          |
|                     | 29  |  | Pos.            |                                 |            | 0.33          |
|                     | 39  | Active power rising time                               | Pos.            | --                              | s          | 0.148         |
|                     | 31  | Reactive power   | Total           | t2+3s to t2+10s                 | p.u.       | 0.04          |
|                     | 32  |  | Pos.            |                                 |            | 0.04          |
|                     | 33  | Reactive power rising time                             | Pos.            | --                              | s          | N/A           |
|                     | 34  | PGU does not disconnect from grid till 60s after fault | --              | t2 to t2+60s                    | Yes / No   | No            |

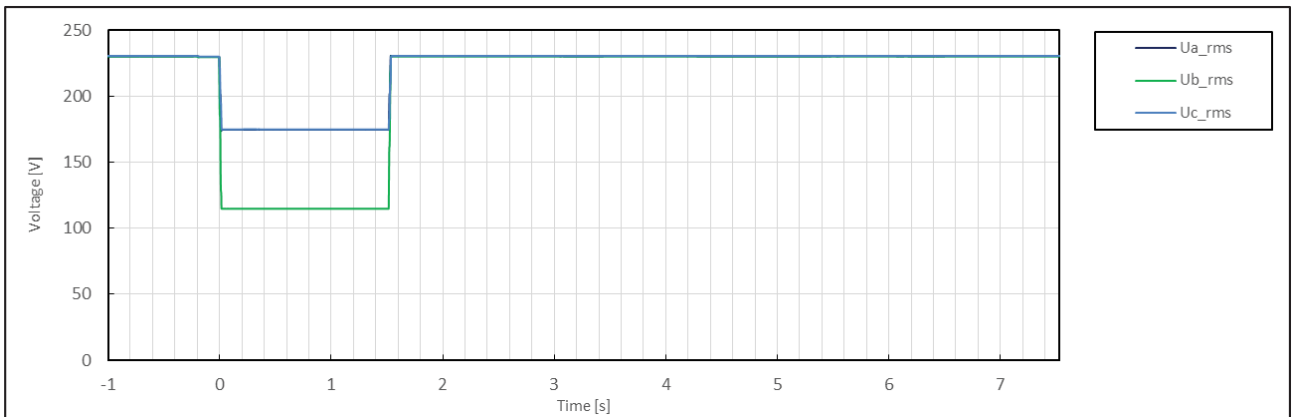
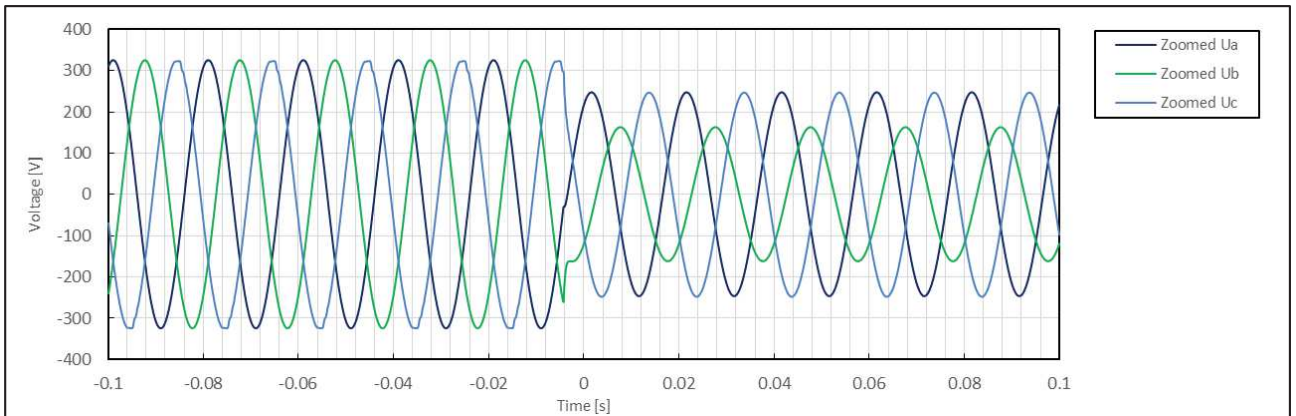
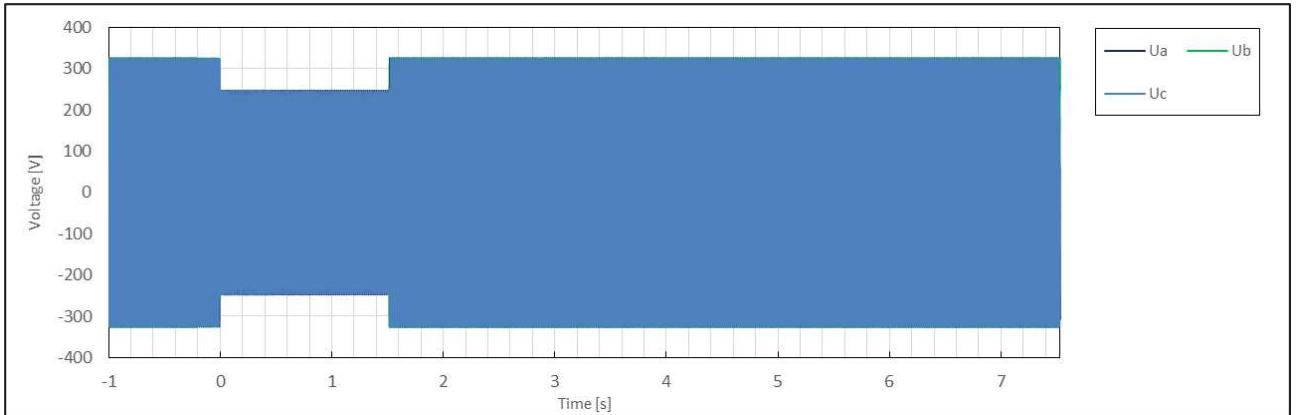

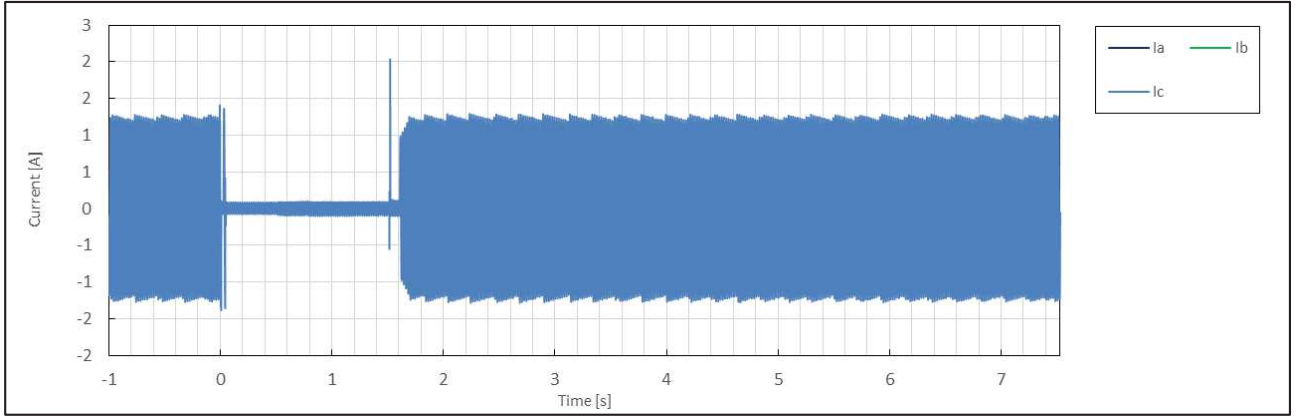
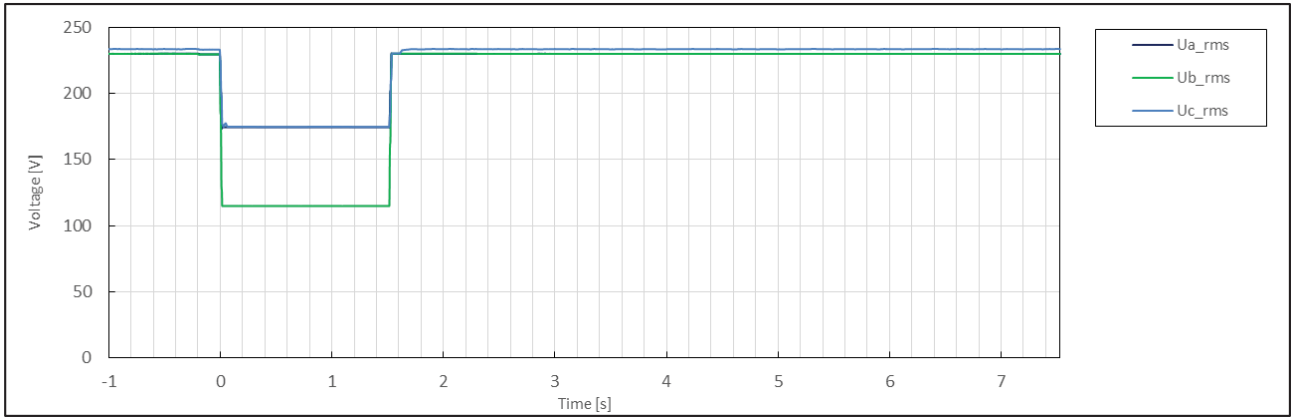
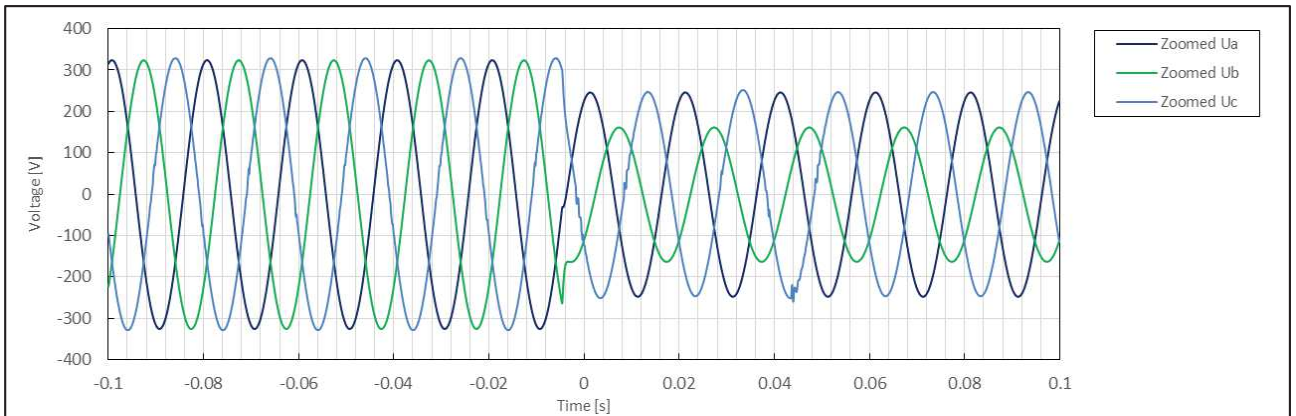
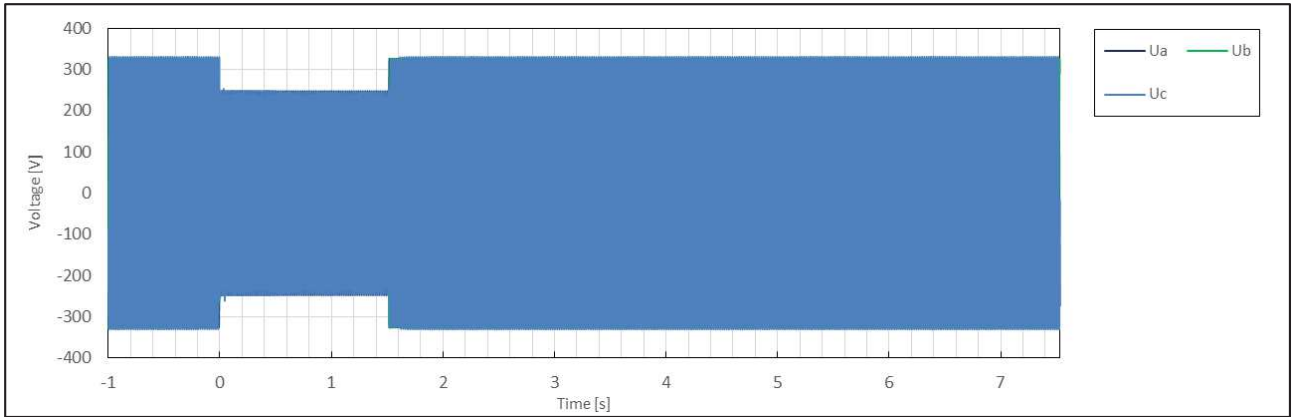

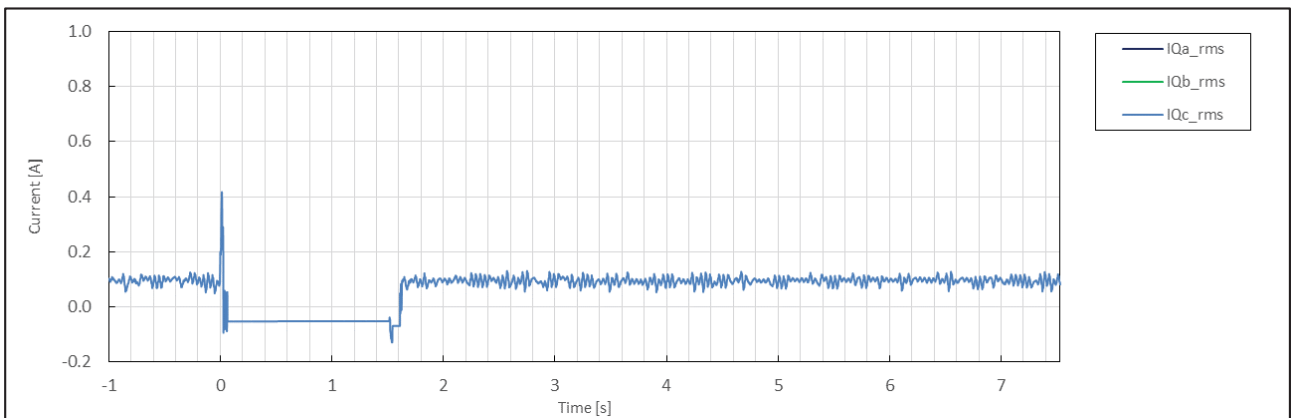
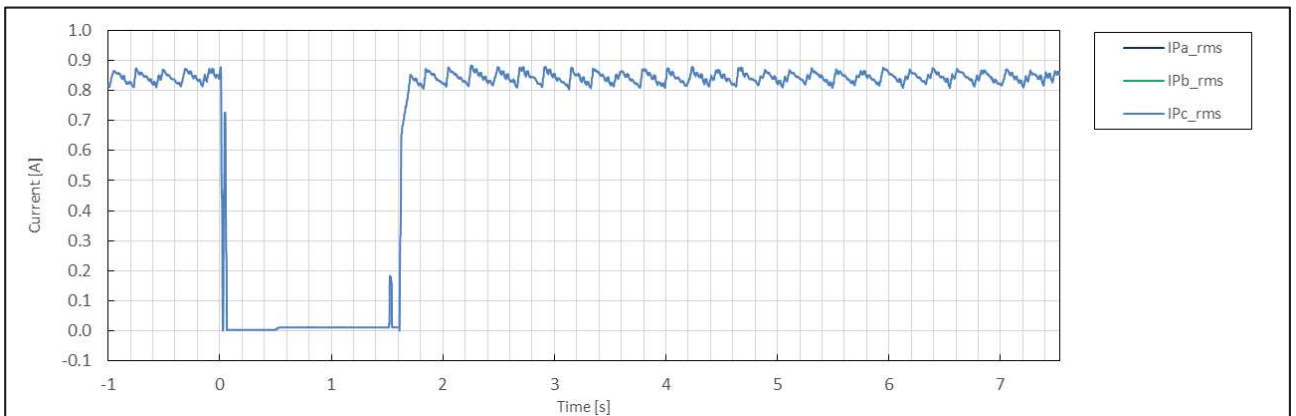
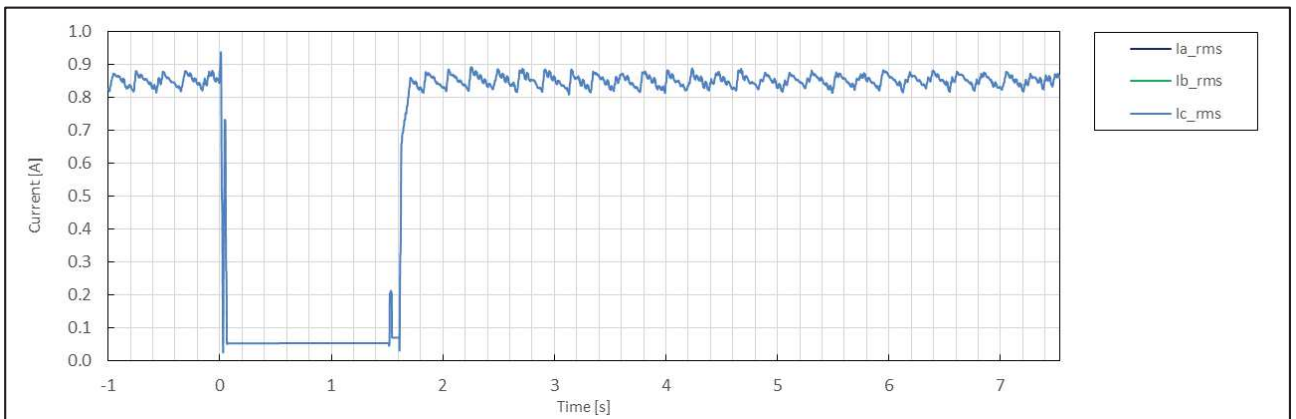
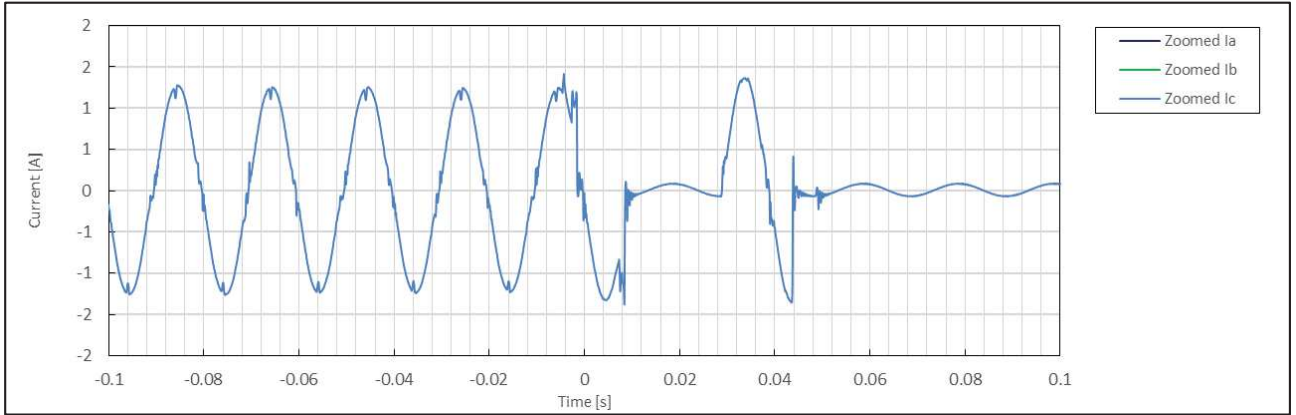

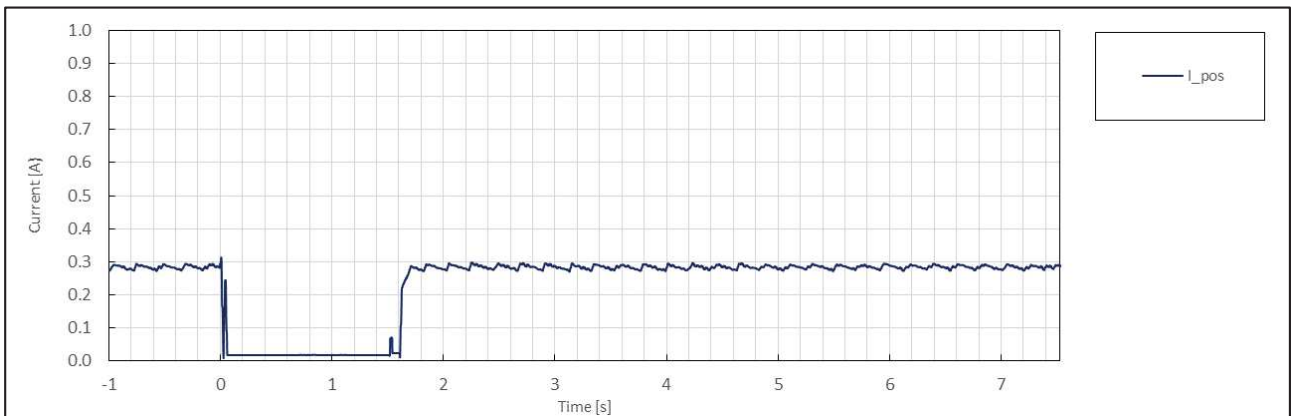
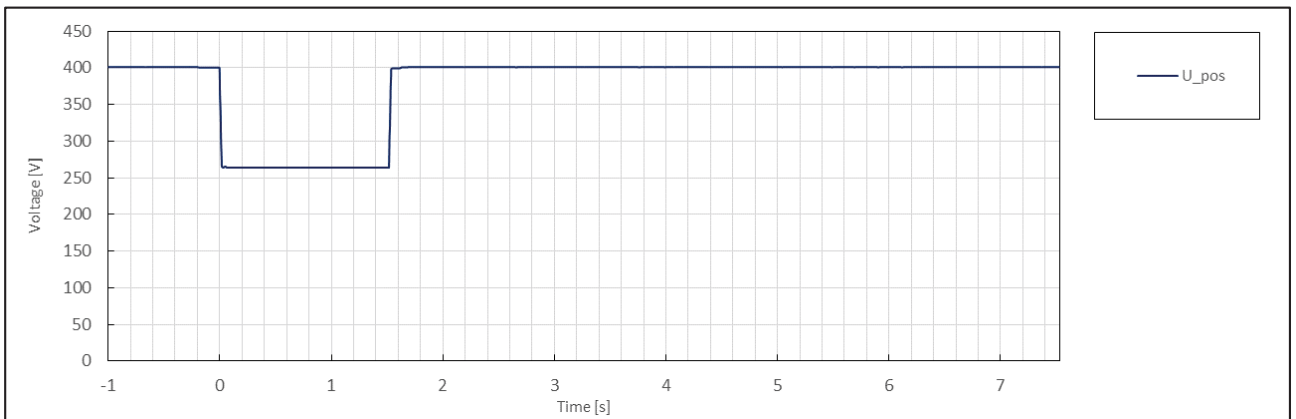
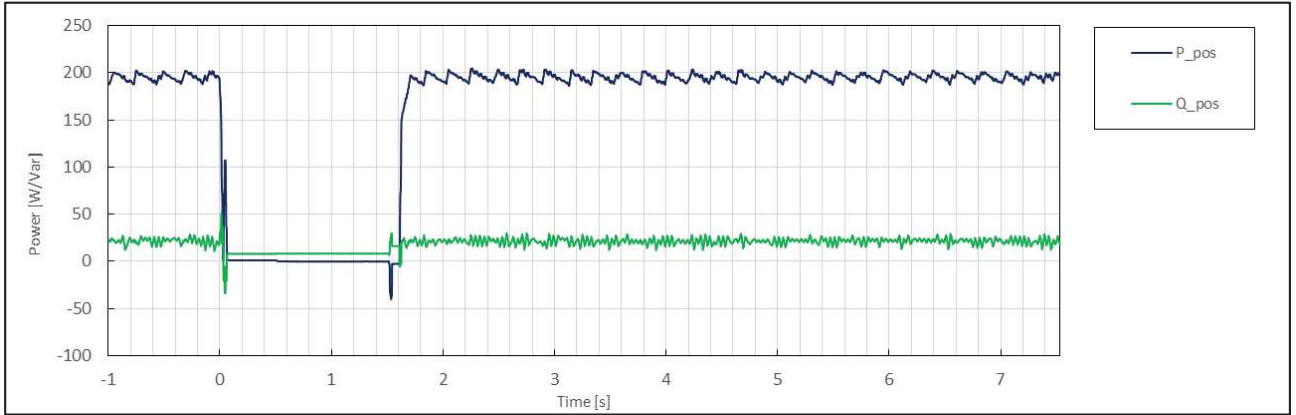

|                     | No. | Parameter  | Phase ref.      | Time ref.                       | unit       | Result        |
|---------------------|-----|--|-----------------|---------------------------------|------------|---------------|
| General Info.       | 0   | Test number  | --              | --                              | --         | 4.1           |
|                     | 1   | Date   | --              | --                              | dd.mm.yyyy | 3.1.2020      |
|                     | 2   | Time (start of test)                                   | --              | --                              | hh:mm:ss.f | 14:09:21      |
|                     | 3   | Fault type (phase)                                     | --              | --                              |            | 3-phase fault |
|                     | 4   | Setting voltage depth                                  | Line to line    | --                              | p.u.       | 0.85          |
|                     | 5   | Setting dip duration                                   |                 | --                              |            | 60035         |
|                     | 6   | Point of fault entry                                   | Total           | --                              | ms         | 0             |
|                     | 7   | Point of fault clearance                               | Total           | --                              | ms         | 60034         |
|                     | 8   | Fault duration in empty load test                      | Total           | --                              | ms         | 60035         |
|                     | 9   | Voltage depth/height in empty load test                | Total           | t1+100ms to t2 and t1-10s to t1 | p.u.       | 0.85          |
|                     | 10  |  | Pos.            |                                 | p.u.       | 0.85          |
| Before dip <t1      | 11  | Voltage  | Line to neutral | t1-100s to t1                   | p.u.       | 1.02          |
|                     | 12  | Current  | Pos.            | t1-500ms to t1-100ms            | p.u.       | 0.32          |
|                     | 13  | Active power   | Total           | t1-10s to t1                    | p.u.       | 1.00          |
|                     | 14  |  | Pos.            |                                 |            | 0.98          |
|                     | 15  | Reactive power   | Total           | t1-10s to t1                    | p.u.       | 0.05          |
|                     | 16  |  | Pos.            |                                 |            | 0.05          |
|                     | 17  | Cos $\varphi$  | --              | t1-10s to t1                    | --         | 0.999         |
| During dip t1 to t2 | 18  | Voltage  | Line to neutral | t1+100ms to t2-20ms             | p.u.       | 0.90          |
|                     | 19  | Line current   | Phase 1         | t1+60ms                         | p.u.       | N/A           |
|                     | 20  |  | Phase 2         |                                 |            | N/A           |
|                     | 21  |  | Phase 3         |                                 |            | 1.16          |
|                     | 22  | Line current   | Phase 1         | t1+100ms                        | p.u.       | N/A           |
|                     | 23  |  | Phase 2         |                                 |            | N/A           |
|                     | 24  |  | Phase 3         |                                 |            | 1.24          |
|                     | 25  | Active power   | Total           | t1+100ms to t2-20ms             | p.u.       | 1.00          |
|                     | 26  |  | Pos.            |                                 |            | 0.96          |
| After dip > t2      | 27  | Voltage  | Line to neutral | t2+3s to t2+10s                 | p.u.       | 1.02          |
|                     | 28  | Active power   | Total           | t2+3s to t2+10s                 | p.u.       | 1.00          |
|                     | 29  |  | Pos.            |                                 |            | 0.97          |
|                     | 39  | Active power rising time                               | Pos.            | --                              | s          | N/A           |
|                     | 31  | Reactive power   | Total           | t2+3s to t2+10s                 | p.u.       | 0.05          |
|                     | 32  |  | Pos.            |                                 |            | 0.05          |
|                     | 33  | Reactive power rising time                             | Pos.            | --                              | s          | N/A           |
|                     | 34  | PGU does not disconnect from grid till 60s after fault | --              | t2 to t2+60s                    | Yes / No   | No            |

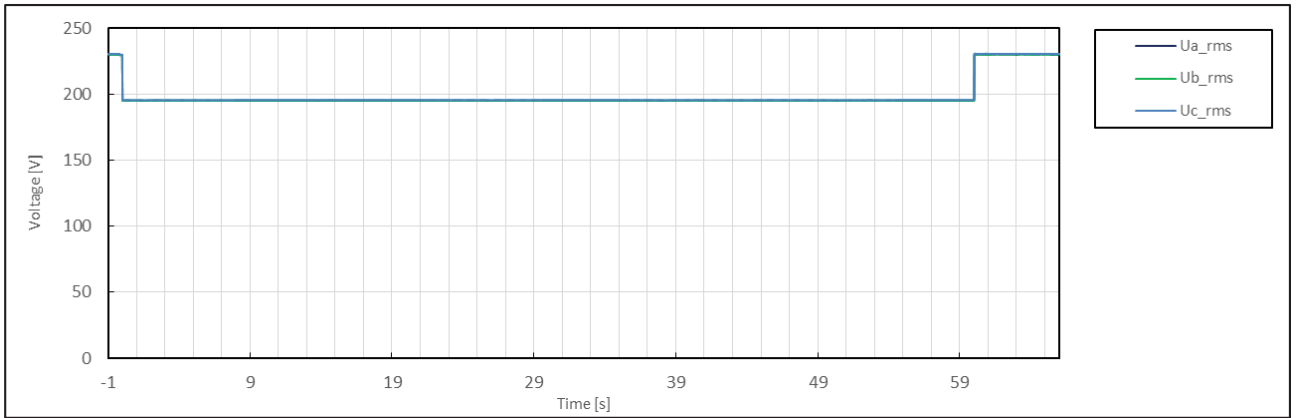
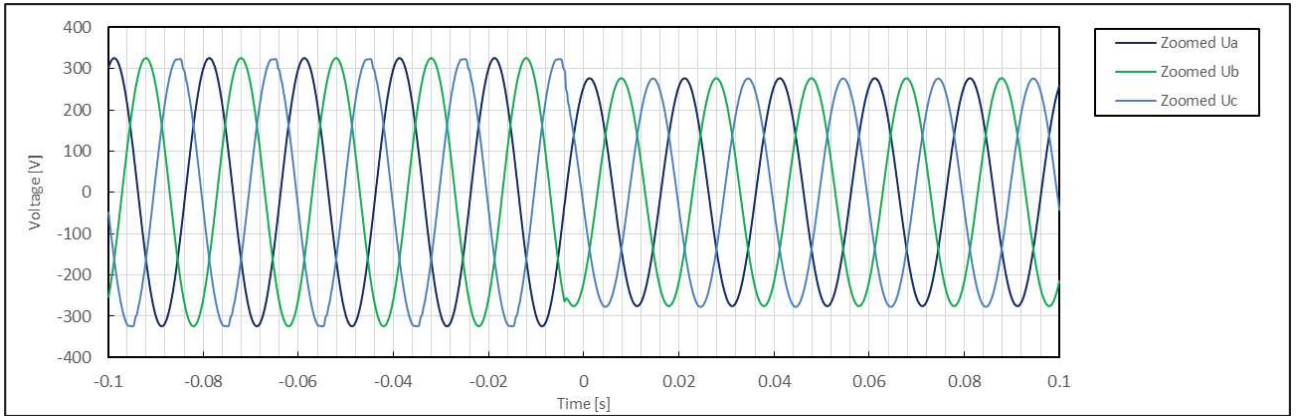
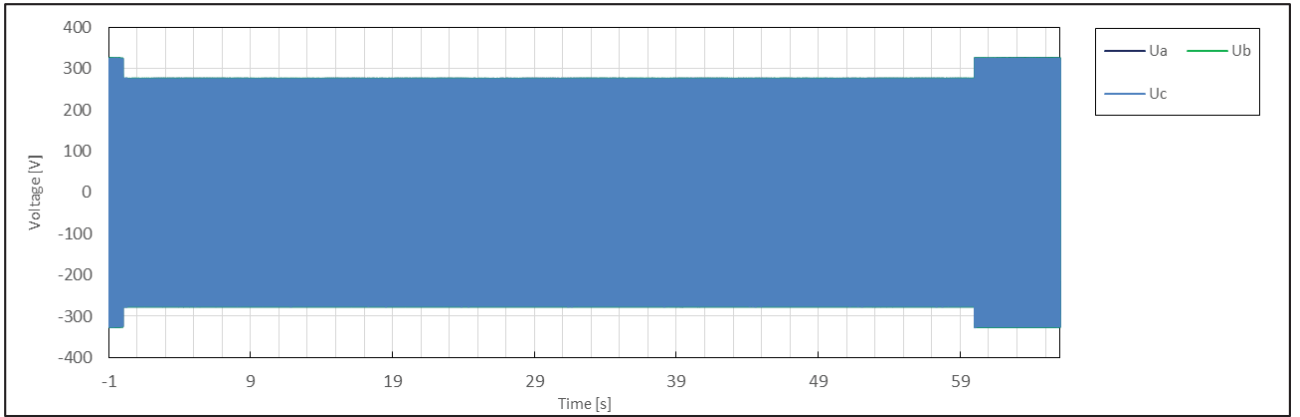



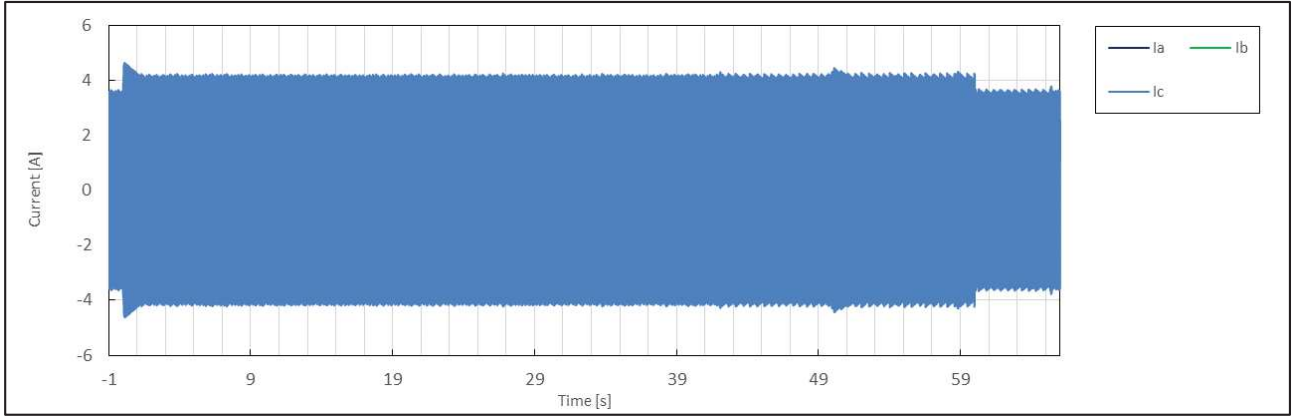
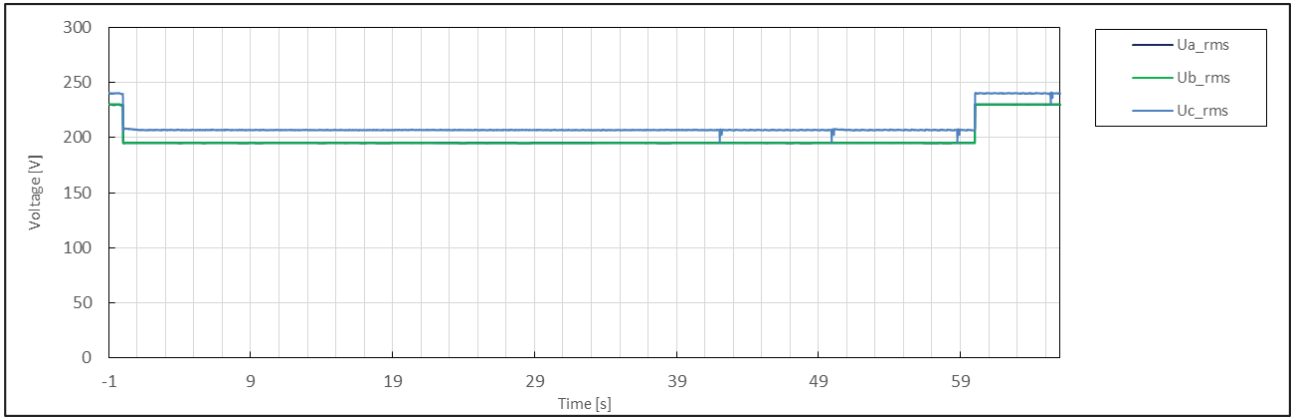
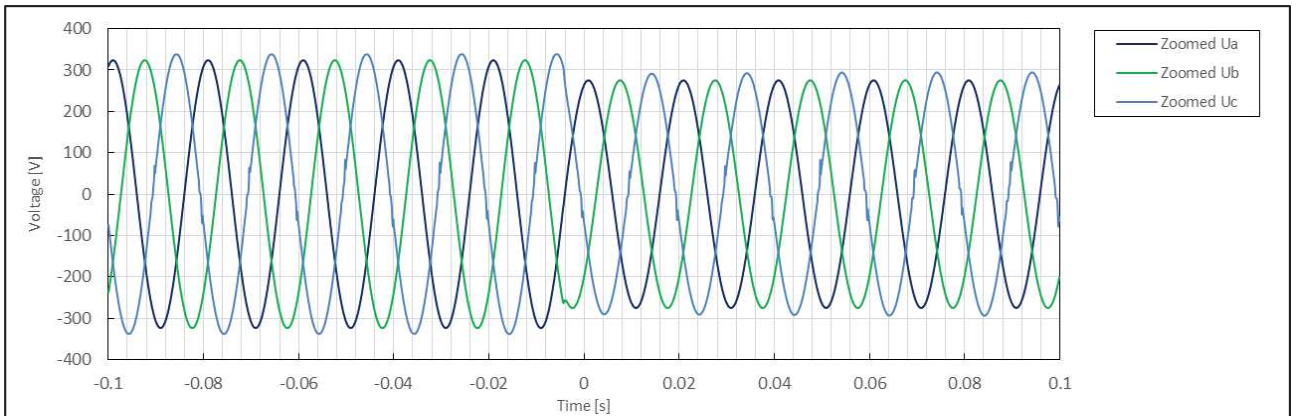
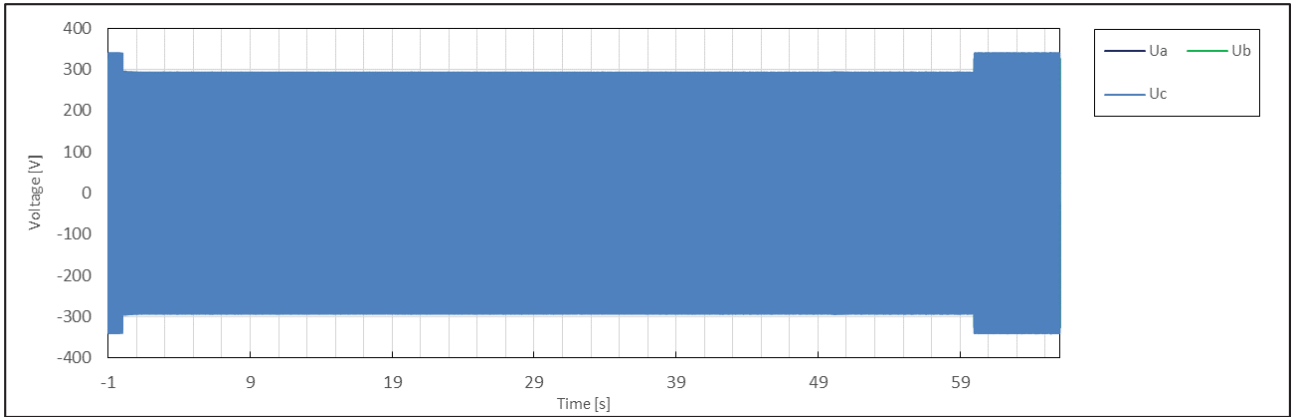

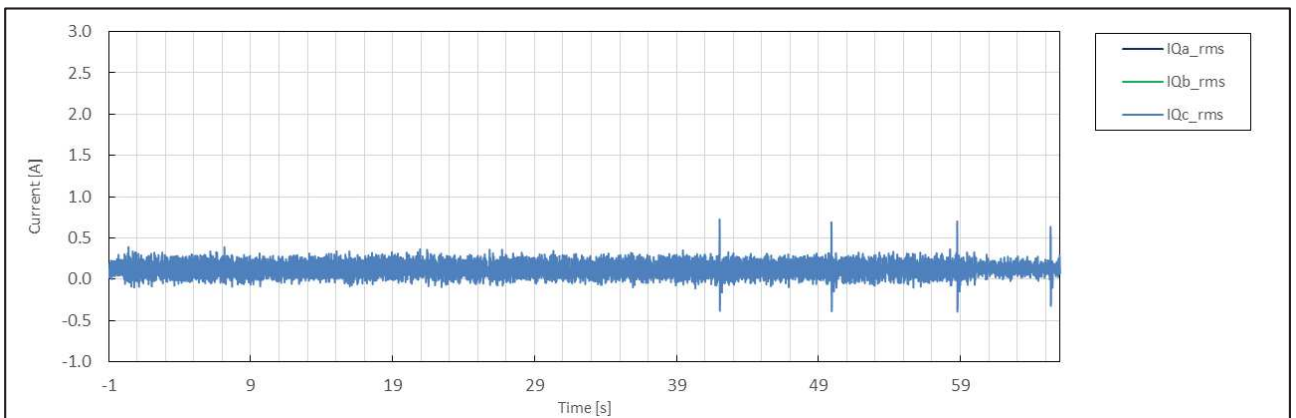
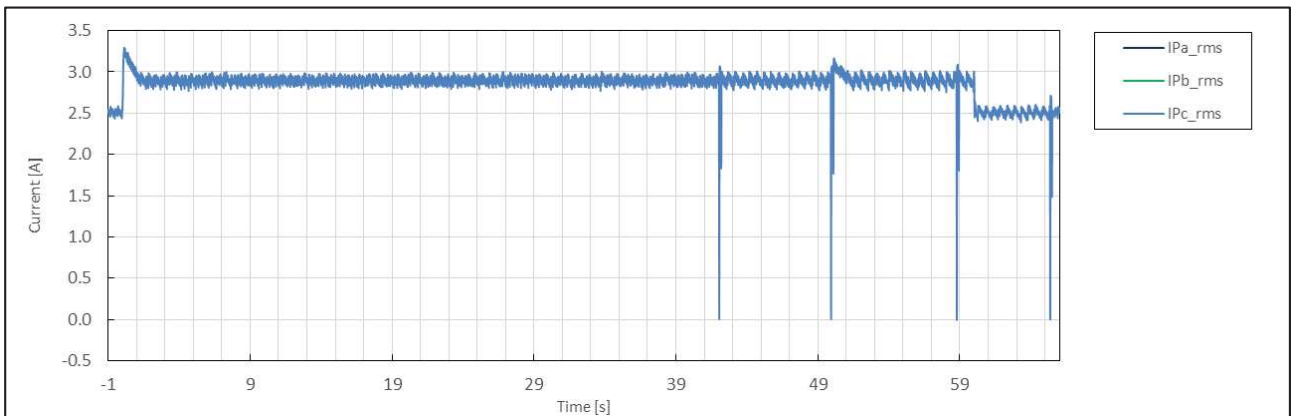
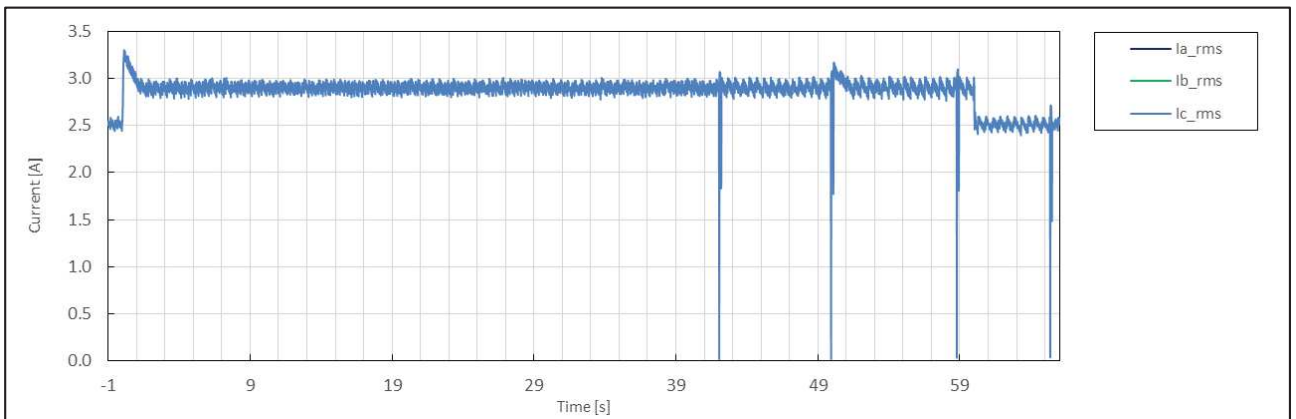
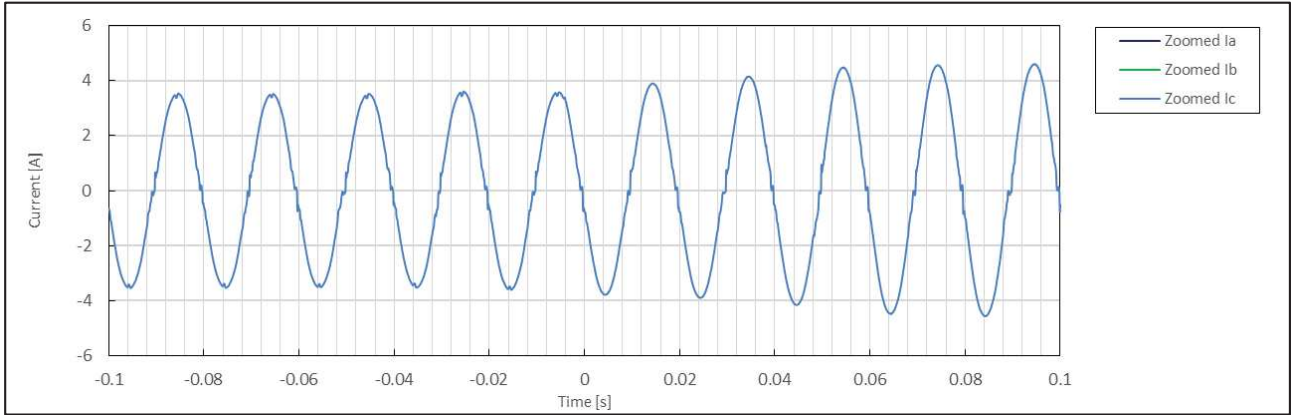

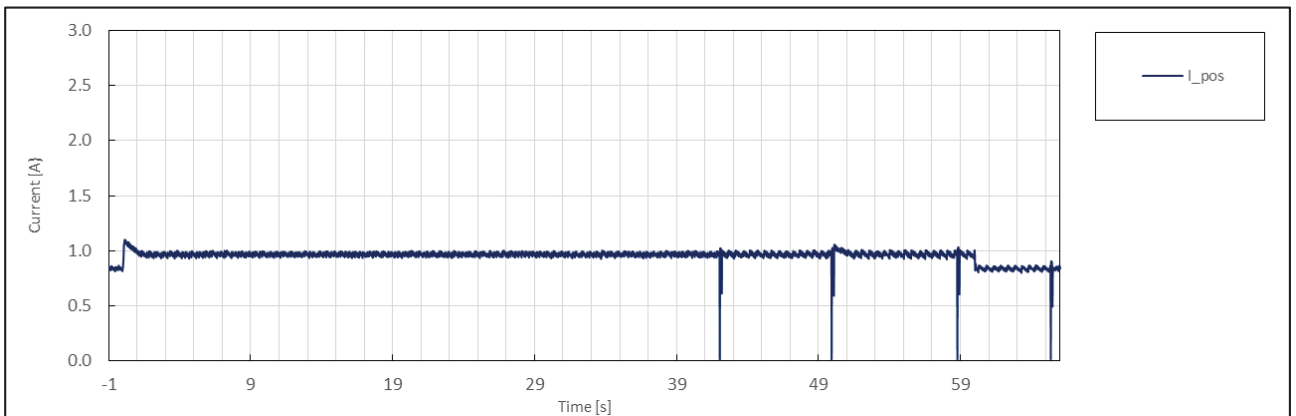
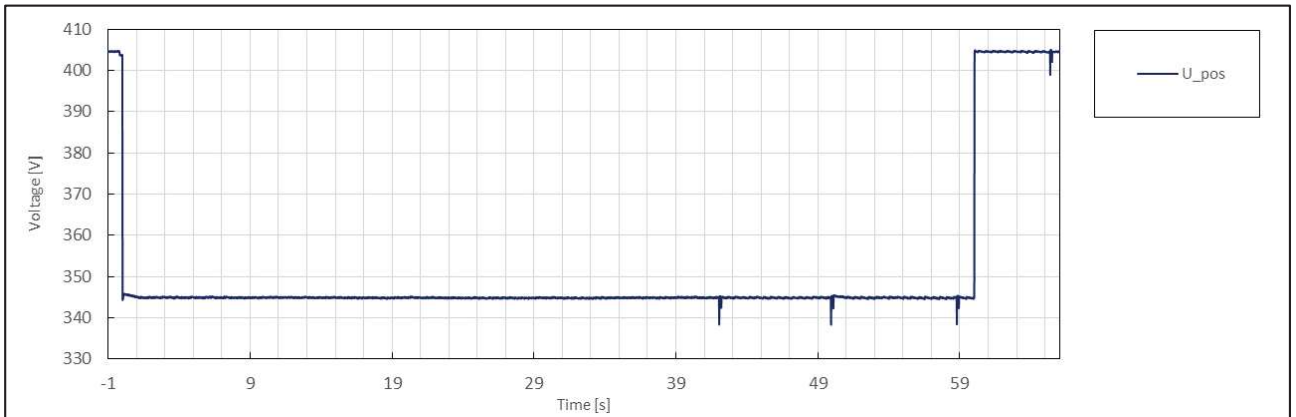
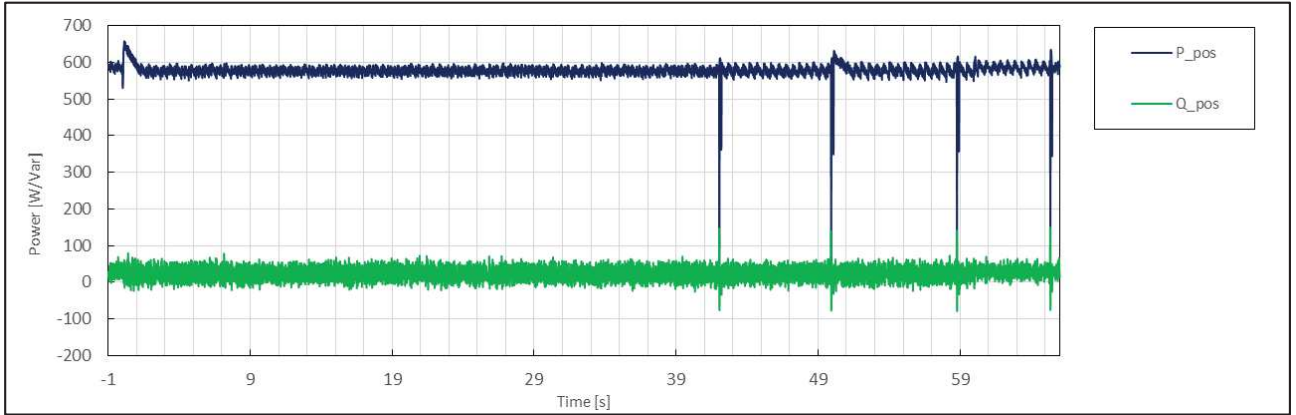

|                     | No. | Parameter  | Phase ref.      | Time ref.                       | unit       | Result        |
|---------------------|-----|--|-----------------|---------------------------------|------------|---------------|
| General Info.       | 0   | Test number  | --              | --                              | --         | 4.2           |
|                     | 1   | Date   | --              | --                              | dd.mm.yyyy | 3.1.2020      |
|                     | 2   | Time (start of test)                                   | --              | --                              | hh:mm:ss.f | 14:15:38      |
|                     | 3   | Fault type (phase)                                     | --              | --                              |            | 3-phase fault |
|                     | 4   | Setting voltage depth                                  | Line to line    | --                              | p.u.       | 0.85          |
|                     | 5   | Setting dip duration                                   |                 | --                              |            | 60035         |
|                     | 6   | Point of fault entry                                   | Total           | --                              | ms         | 0             |
|                     | 7   | Point of fault clearance                               | Total           | --                              | ms         | 60034         |
|                     | 8   | Fault duration in empty load test                      | Total           | --                              | ms         | 60035         |
|                     | 9   | Voltage depth/height in empty load test                | Total           | t1+100ms to t2 and t1-10s to t1 | p.u.       | 0.85          |
|                     | 10  |  | Pos.            |                                 | p.u.       | 0.85          |
| Before dip <t1      | 11  | Voltage  | Line to neutral | t1-100s to t1                   | p.u.       | 1.01          |
|                     | 12  | Current  | Pos.            | t1-500ms to t1-100ms            | p.u.       | 0.11          |
|                     | 13  | Active power   | Total           | t1-10s to t1                    | p.u.       | 0.33          |
|                     | 14  |  | Pos.            |                                 |            | 0.32          |
|                     | 15  | Reactive power   | Total           | t1-10s to t1                    | p.u.       | 0.04          |
|                     | 16  |  | Pos.            |                                 |            | 0.04          |
|                     | 17  | Cos $\varphi$  | --              | t1-10s to t1                    | --         | 0.994         |
| During dip t1 to t2 | 18  | Voltage  | Line to neutral | t1+100ms to t2-20ms             | p.u.       | 0.87          |
|                     | 19  | Line current   | Phase 1         | t1+60ms                         | p.u.       | N/A           |
|                     | 20  |  | Phase 2         |                                 |            | N/A           |
|                     | 21  |  | Phase 3         |                                 |            | 0.40          |
|                     | 22  | Line current   | Phase 1         | t1+100ms                        | p.u.       | N/A           |
|                     | 23  |  | Phase 2         |                                 |            | N/A           |
|                     | 24  |  | Phase 3         |                                 |            | 0.42          |
|                     | 25  | Active power   | Total           | t1+100ms to t2-20ms             | p.u.       | 0.33          |
|                     | 26  |  | Pos.            |                                 |            | 0.32          |
| After dip > t2      | 27  | Voltage  | Line to neutral | t2+3s to t2+10s                 | p.u.       | 1.01          |
|                     | 28  | Active power   | Total           | t2+3s to t2+10s                 | p.u.       | 0.33          |
|                     | 29  |  | Pos.            |                                 |            | 0.32          |
|                     | 39  | Active power rising time                               | Pos.            | --                              | s          | N/A           |
|                     | 31  | Reactive power   | Total           | t2+3s to t2+10s                 | p.u.       | 0.04          |
|                     | 32  |  | Pos.            |                                 |            | 0.04          |
|                     | 33  | Reactive power rising time                             | Pos.            | --                              | s          | N/A           |
|                     | 34  | PGU does not disconnect from grid till 60s after fault | --              | t2 to t2+60s                    | Yes / No   | No            |

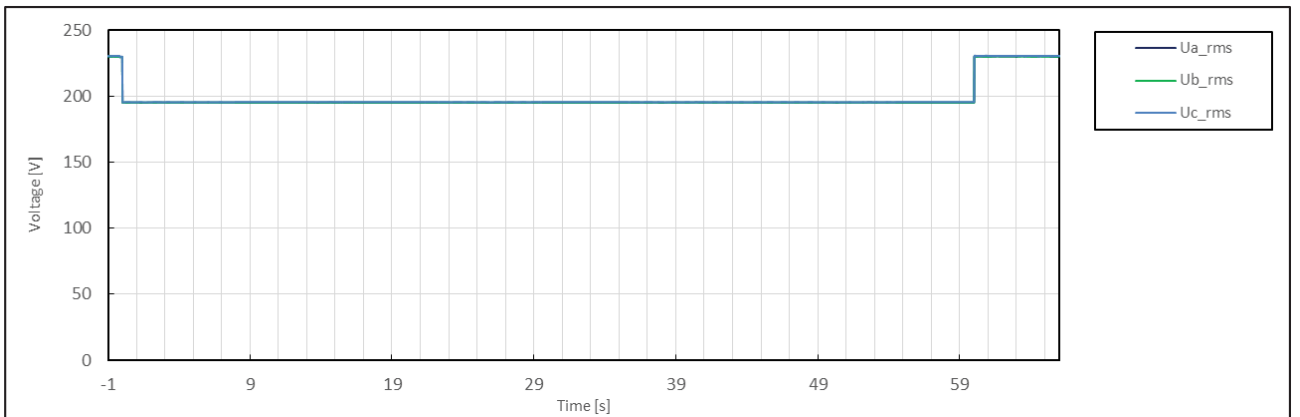
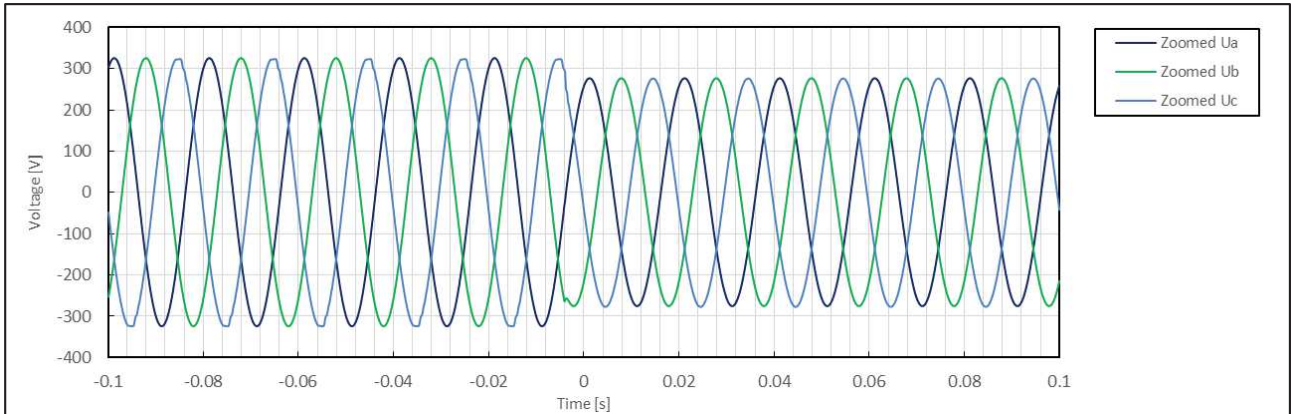
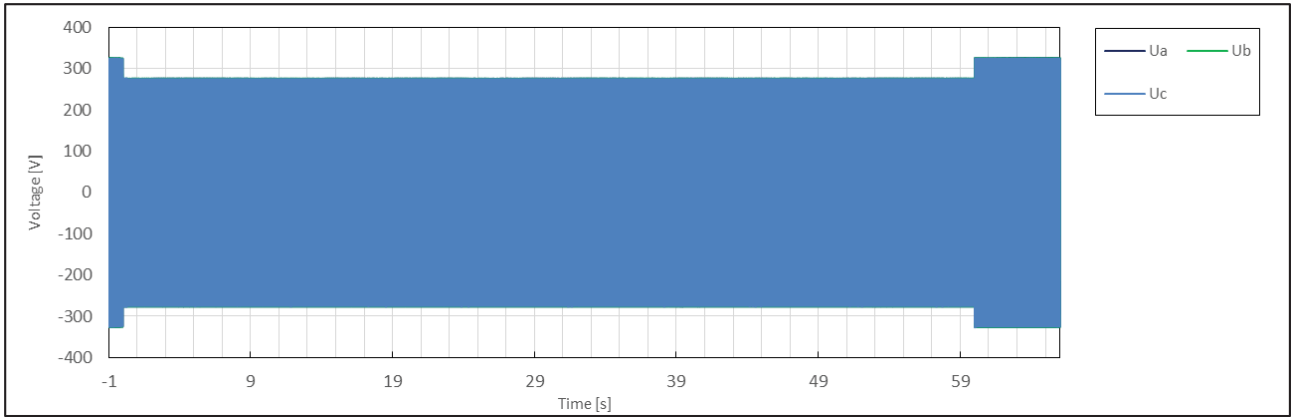

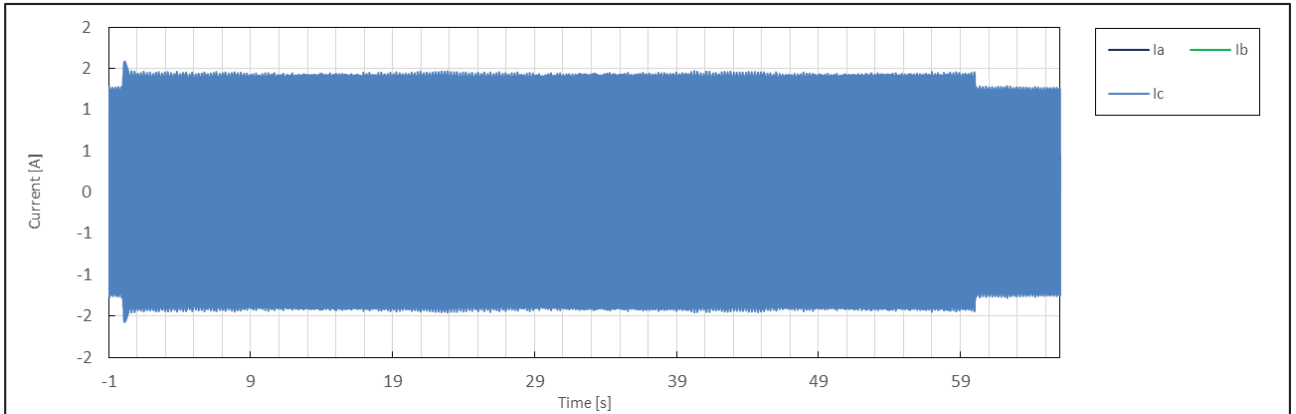
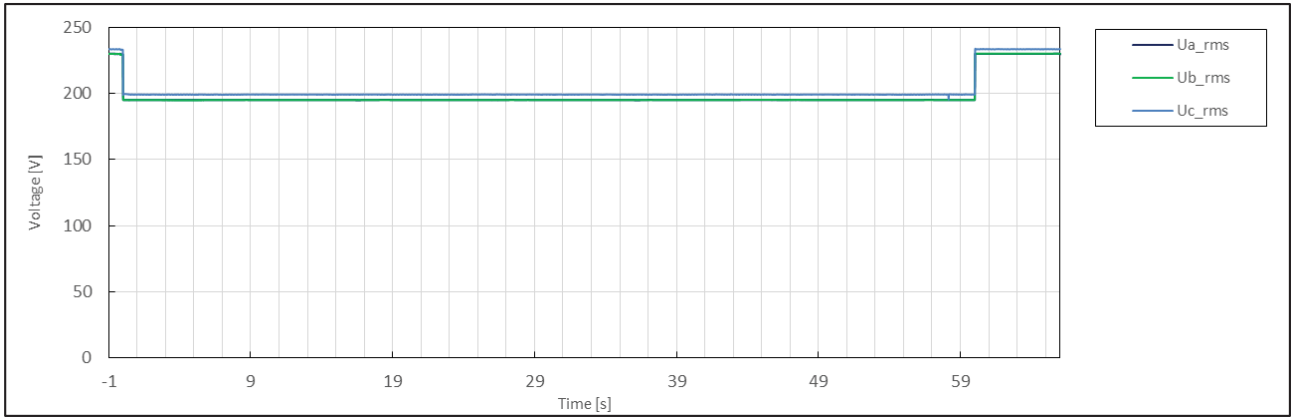
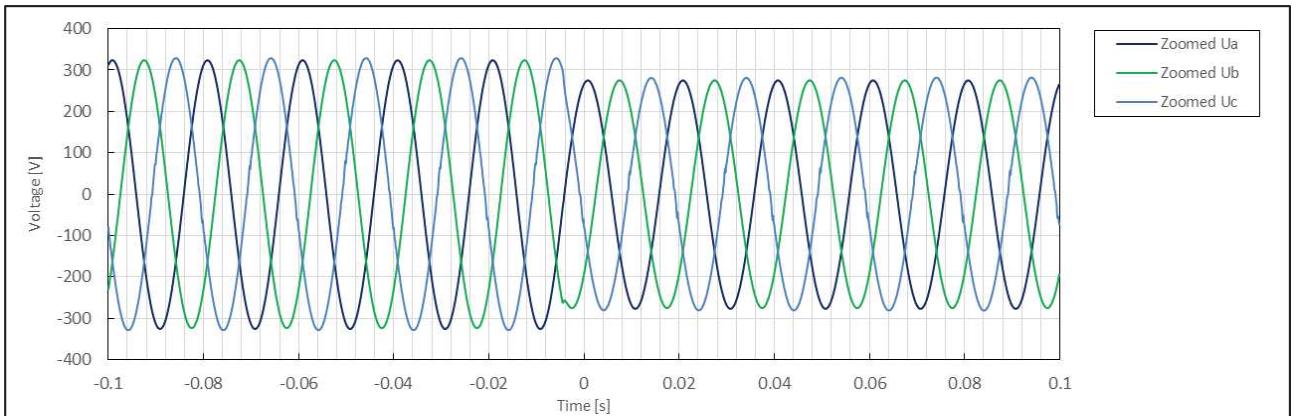
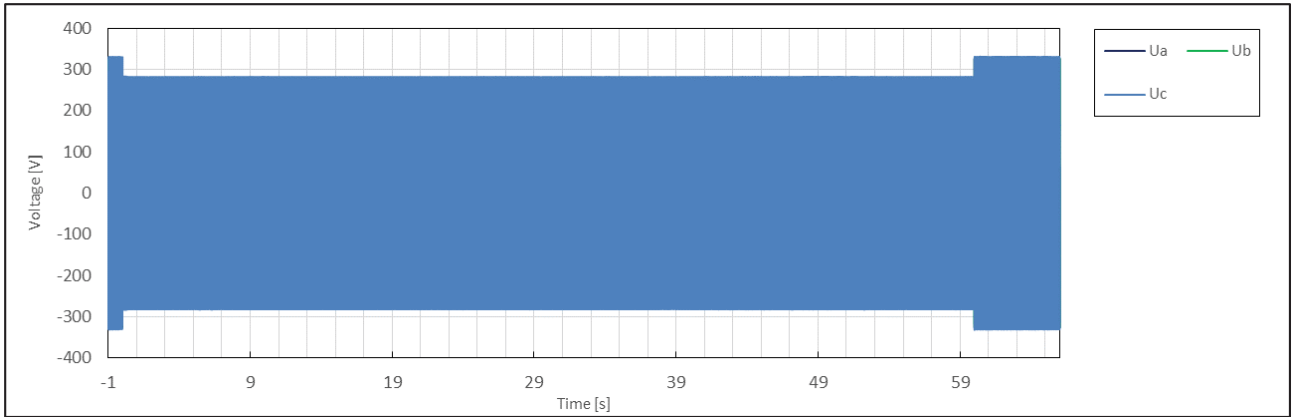

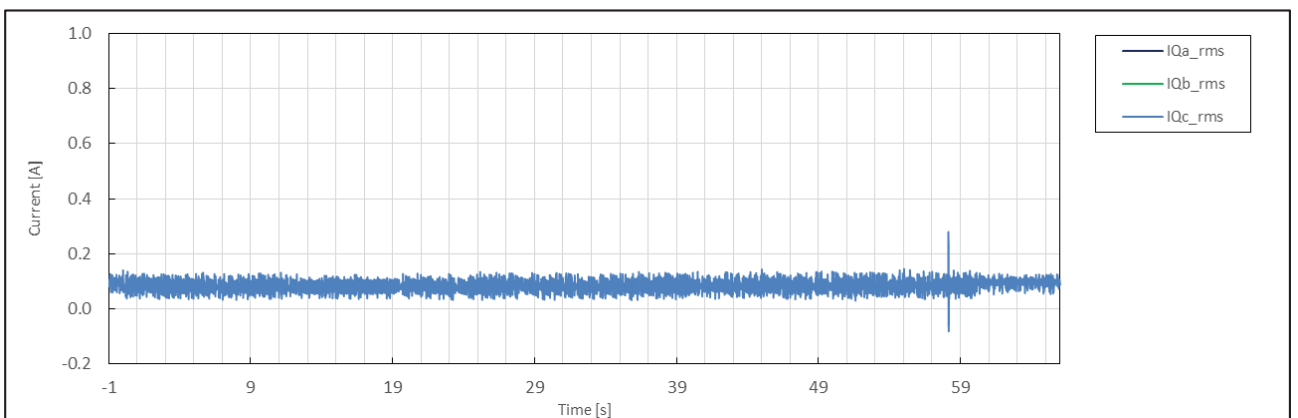
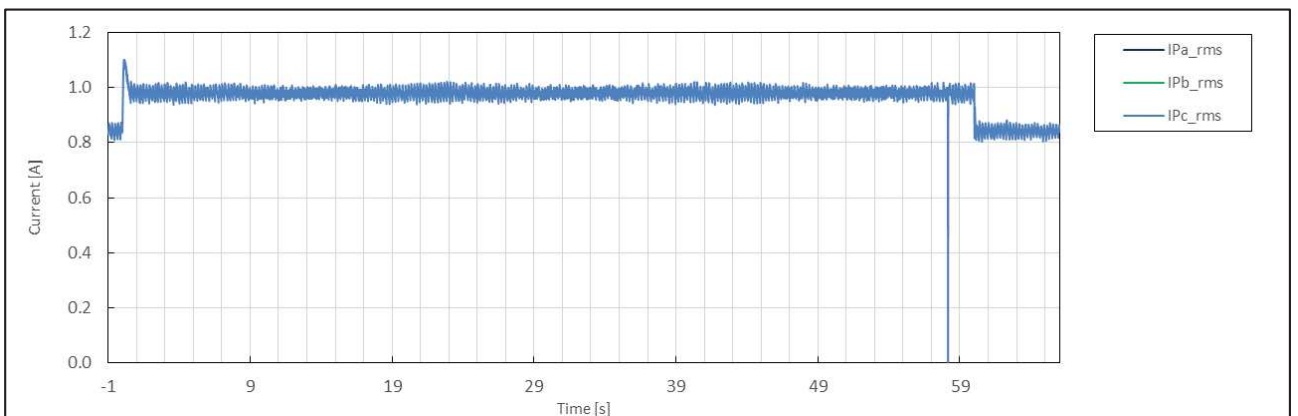
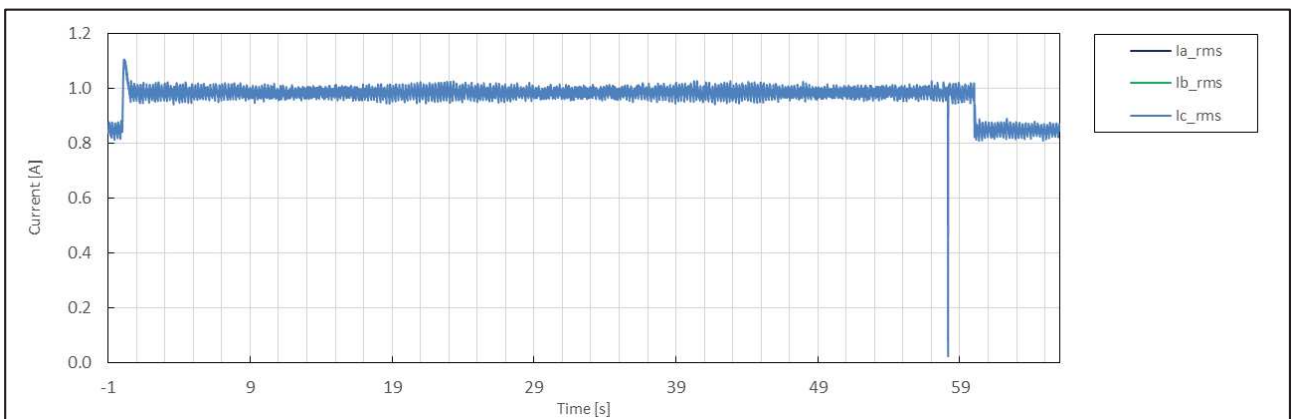
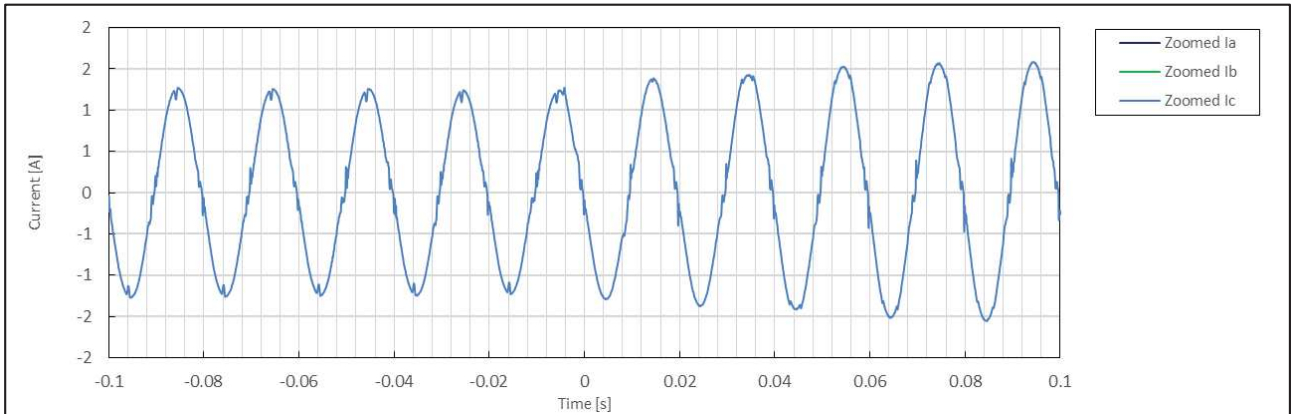

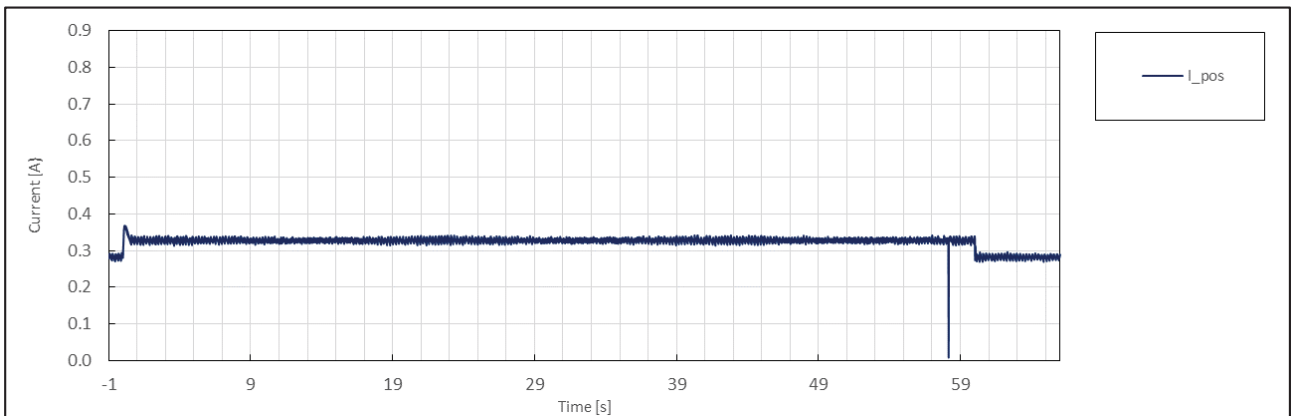
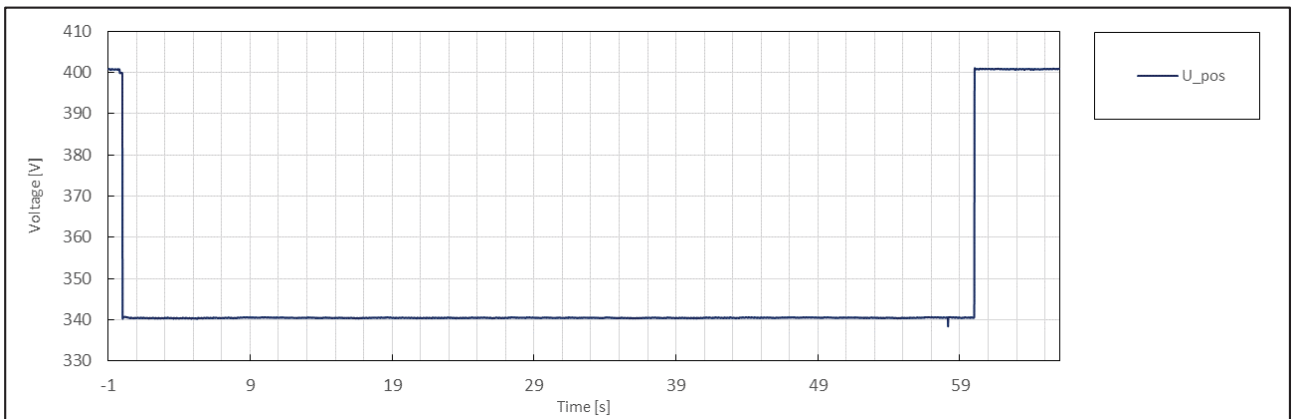
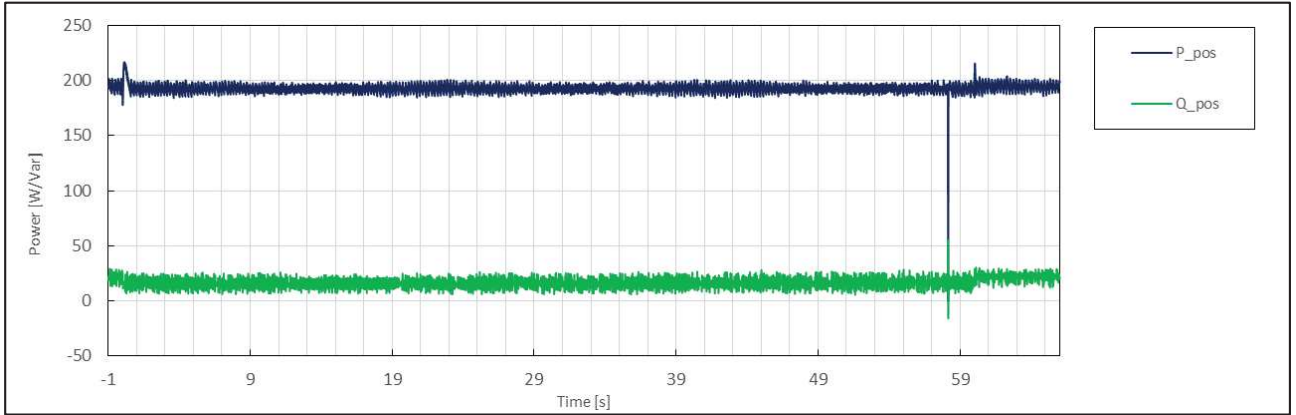



|                     | No. | Parameter  | Phase ref.      | Time ref.                       | unit       | Result        |
|---------------------|-----|--|-----------------|---------------------------------|------------|---------------|
| General Info.       | 0   | Test number  | --              | --                              | --         | 4.3           |
|                     | 1   | Date   | --              | --                              | dd.mm.yyyy | 3.1.2020      |
|                     | 2   | Time (start of test)                                   | --              | --                              | hh:mm:ss.f | 14:19:56      |
|                     | 3   | Fault type (phase)                                     | --              | --                              |            | 2-phase fault |
|                     | 4   | Setting voltage depth                                  | Line to line    | --                              | p.u.       | 0.85          |
|                     | 5   | Setting dip duration                                   |                 | --                              |            | 60030         |
|                     | 6   | Point of fault entry                                   | Total           | --                              | ms         | 0             |
|                     | 7   | Point of fault clearance                               | Total           | --                              | ms         | 60029         |
|                     | 8   | Fault duration in empty load test                      | Total           | --                              | ms         | 60030         |
|                     | 9   | Voltage depth/height in empty load test                | Total           | t1+100ms to t2 and t1-10s to t1 | p.u.       | 0.93          |
|                     | 10  |  | Pos.            |                                 | p.u.       | 0.90          |
| Before dip <t1      | 11  | Voltage  | Line to neutral | t1-100s to t1                   | p.u.       | 1.02          |
|                     | 12  | Current  | Pos.            | t1-500ms to t1-100ms            | p.u.       | 0.32          |
|                     | 13  | Active power   | Total           | t1-10s to t1                    | p.u.       | 1.00          |
|                     | 14  |  | Pos.            |                                 |            | 0.98          |
|                     | 15  | Reactive power   | Total           | t1-10s to t1                    | p.u.       | 0.05          |
|                     | 16  |  | Pos.            |                                 |            | 0.04          |
|                     | 17  | Cos $\varphi$  | --              | t1-10s to t1                    | --         | 0.999         |
| During dip t1 to t2 | 18  | Voltage  | Line to neutral | t1+100ms to t2-20ms             | p.u.       | 0.98          |
|                     | 19  | Line current   | Phase 1         | t1+60ms                         | p.u.       | N/A           |
|                     | 20  |  | Phase 2         |                                 |            | N/A           |
|                     | 21  |  | Phase 3         |                                 |            | 1.05          |
|                     | 22  | Line current   | Phase 1         | t1+100ms                        | p.u.       | N/A           |
|                     | 23  |  | Phase 2         |                                 |            | N/A           |
|                     | 24  |  | Phase 3         |                                 |            | 1.07          |
|                     | 25  | Active power   | Total           | t1+100ms to t2-20ms             | p.u.       | 1.00          |
|                     | 26  |  | Pos.            |                                 |            | 0.94          |
| After dip > t2      | 27  | Voltage  | Line to neutral | t2+3s to t2+10s                 | p.u.       | 1.02          |
|                     | 28  | Active power   | Total           | t2+3s to t2+10s                 | p.u.       | 1.00          |
|                     | 29  |  | Pos.            |                                 |            | 0.97          |
|                     | 39  | Active power rising time                               | Pos.            | --                              | s          | N/A           |
|                     | 31  | Reactive power   | Total           | t2+3s to t2+10s                 | p.u.       | 0.05          |
|                     | 32  |  | Pos.            |                                 |            | 0.05          |
|                     | 33  | Reactive power rising time                             | Pos.            | --                              | s          | N/A           |
|                     | 34  | PGU does not disconnect from grid till 60s after fault | --              | t2 to t2+60s                    | Yes / No   | No            |

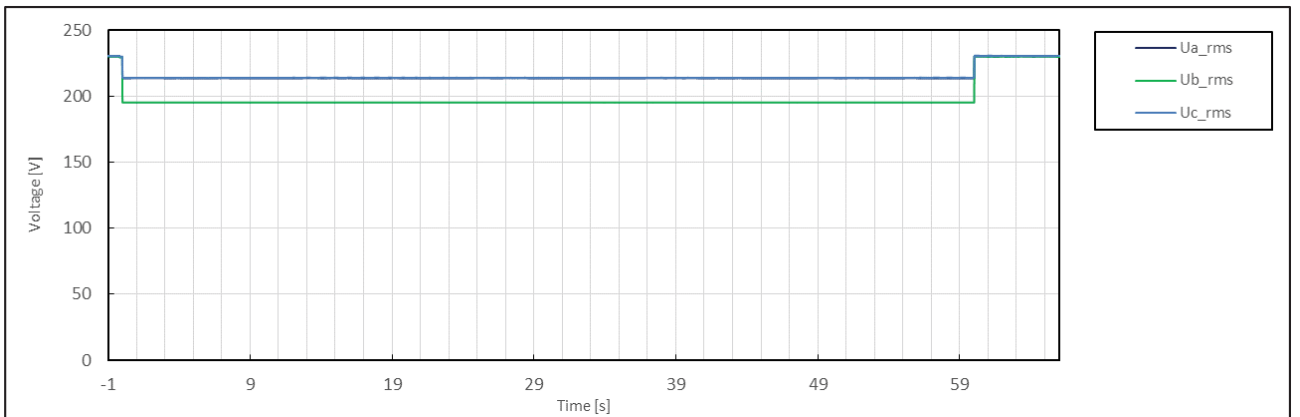
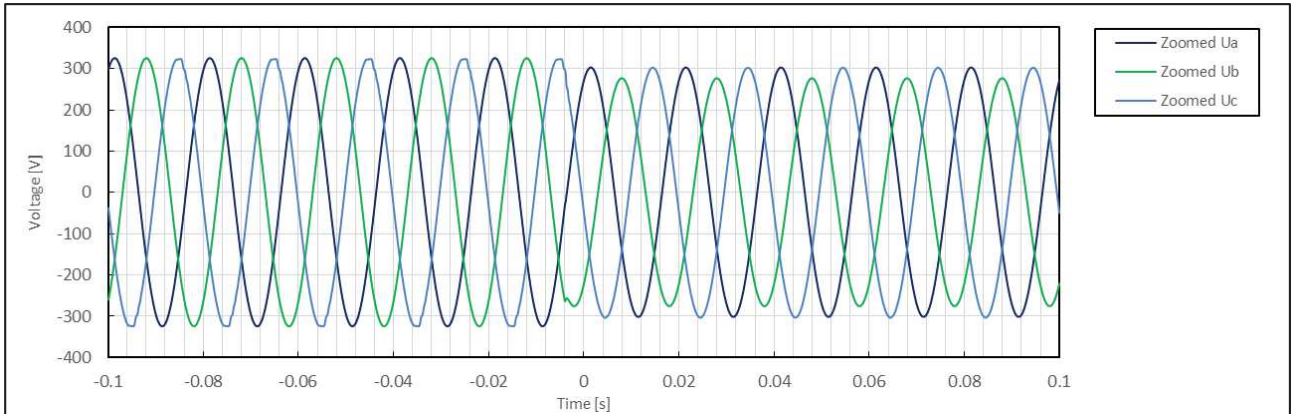
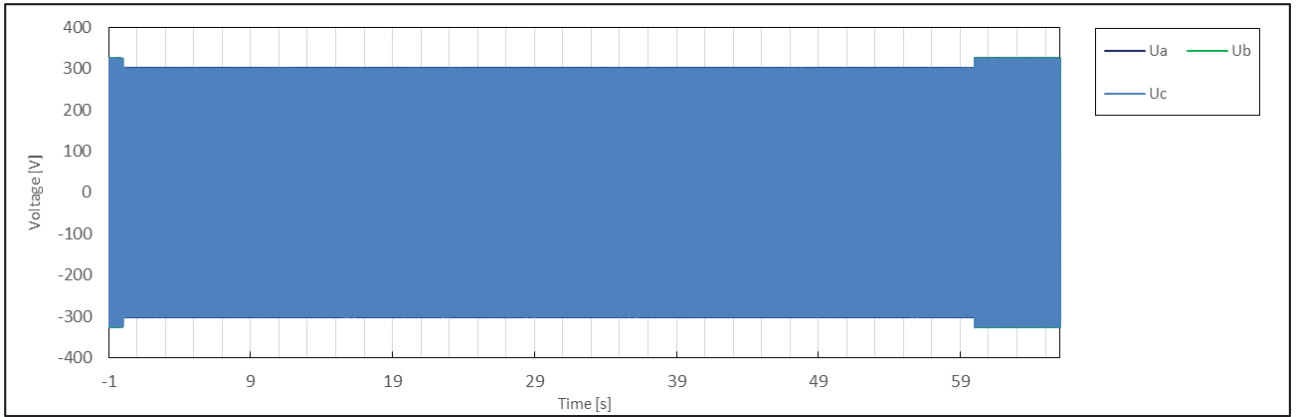

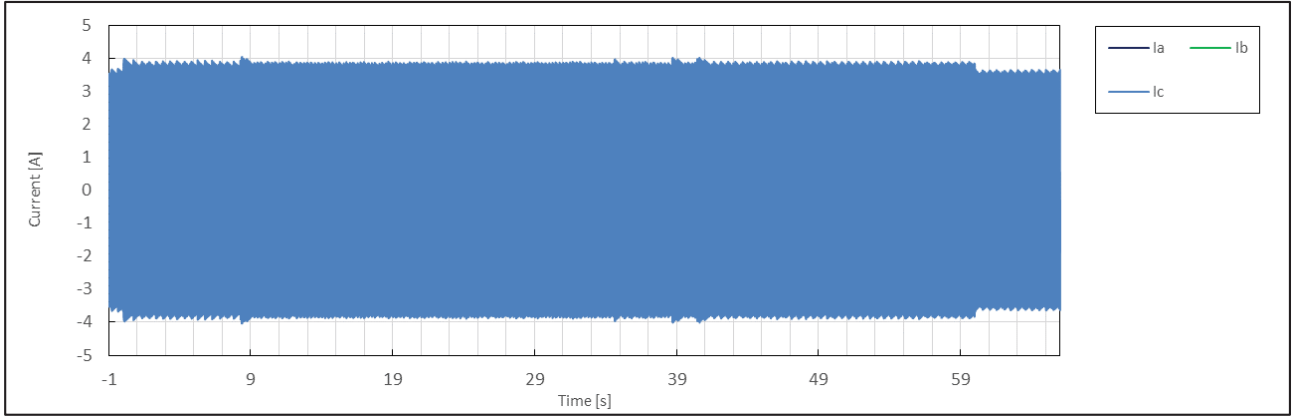
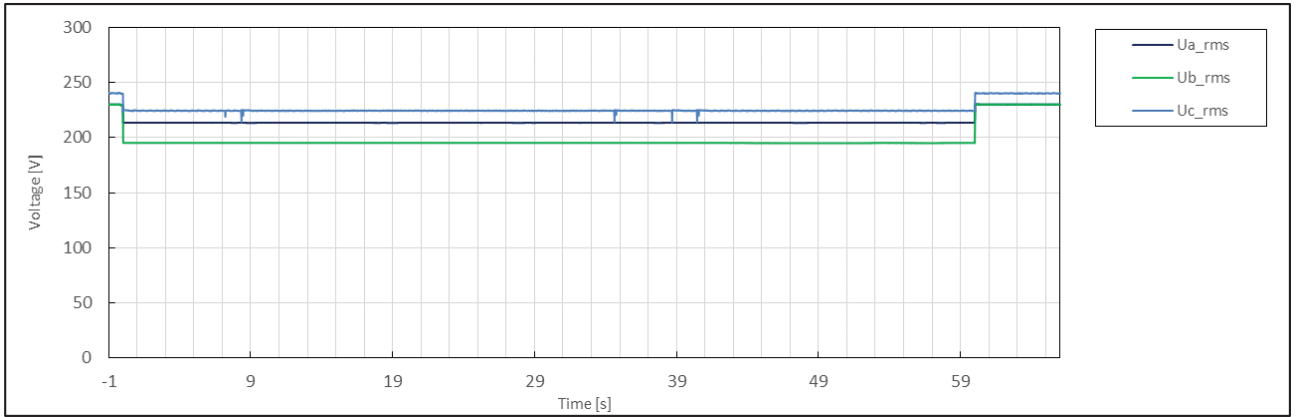
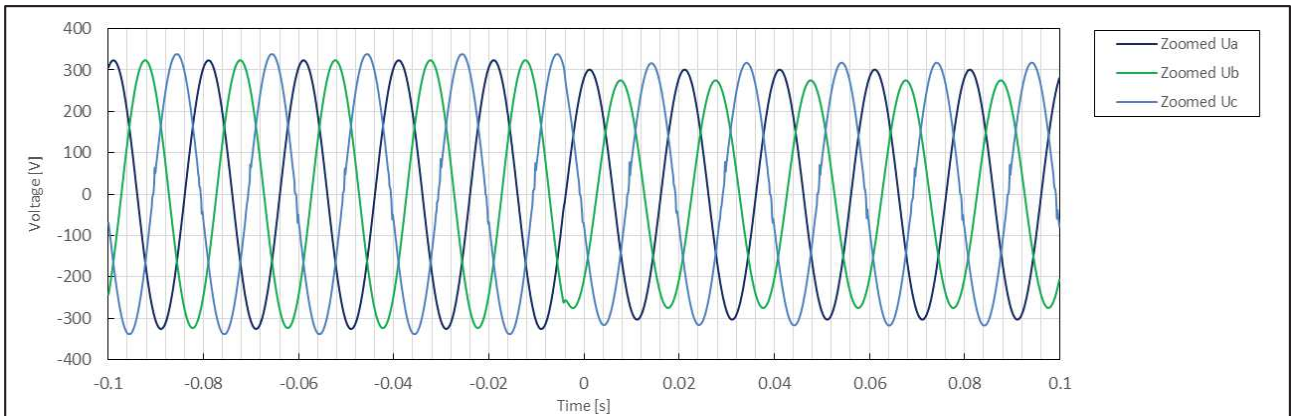
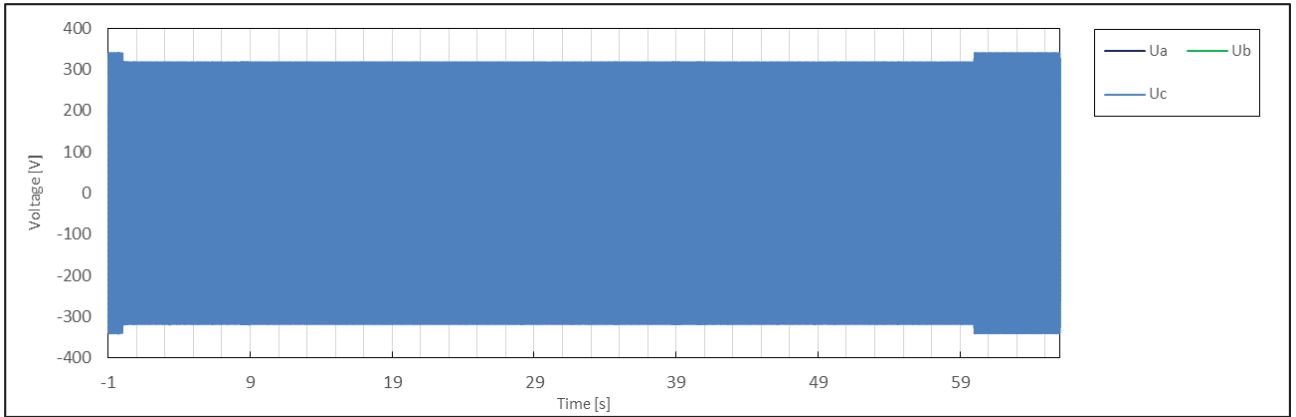

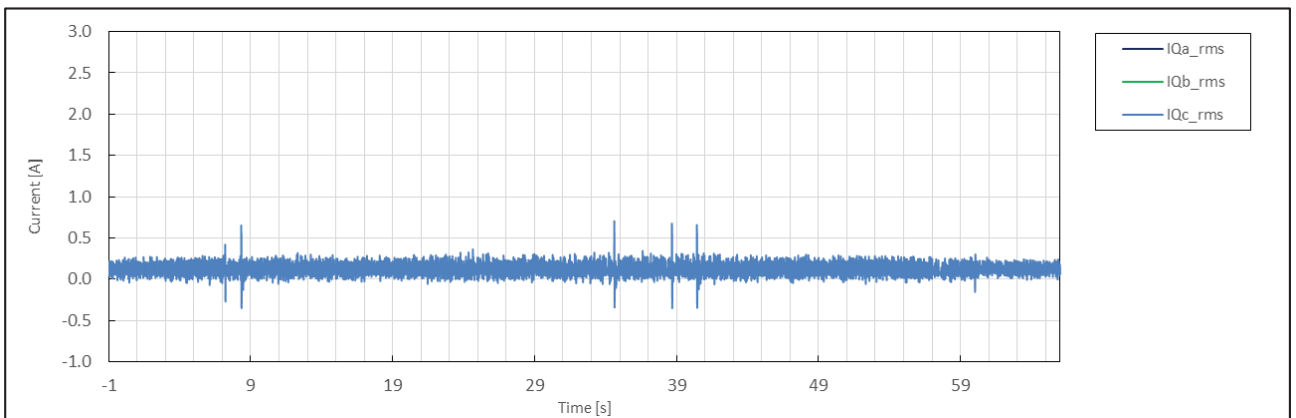
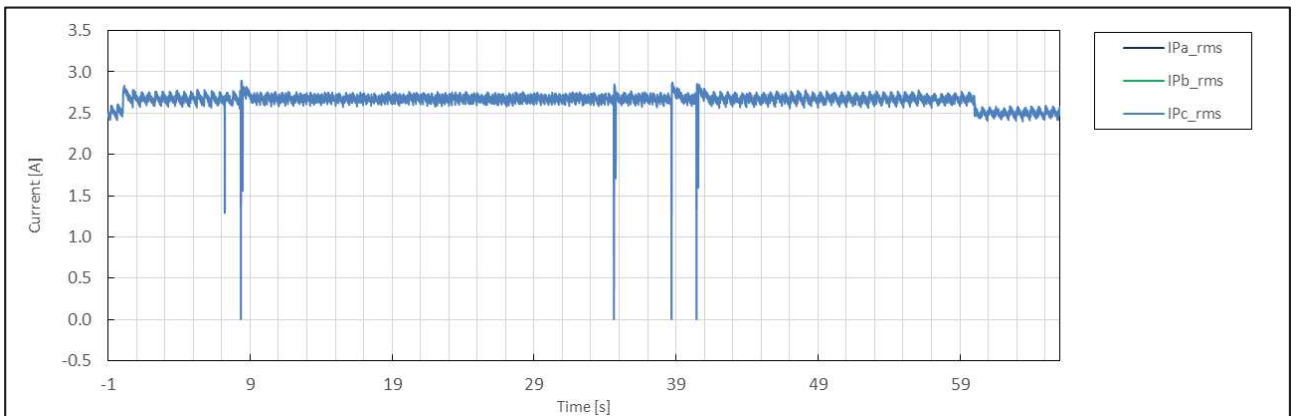
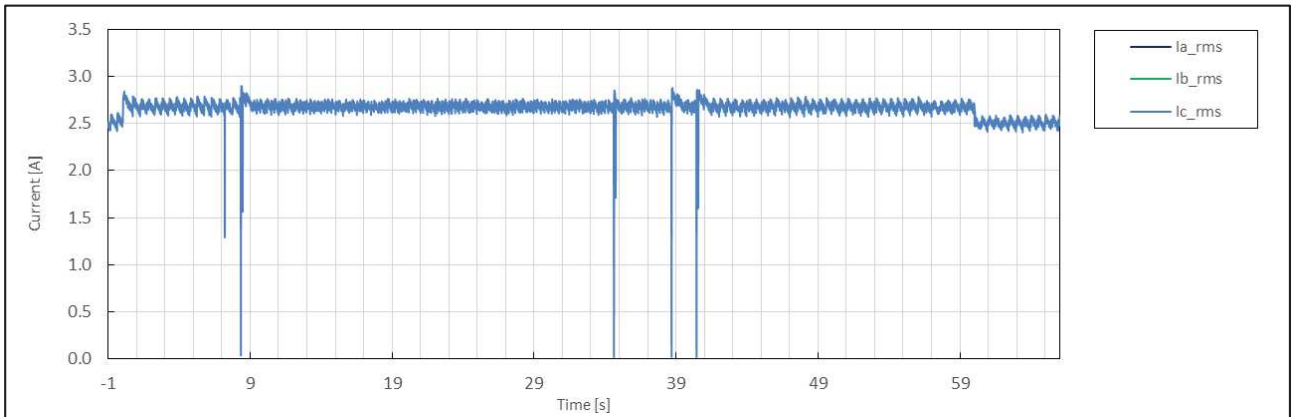
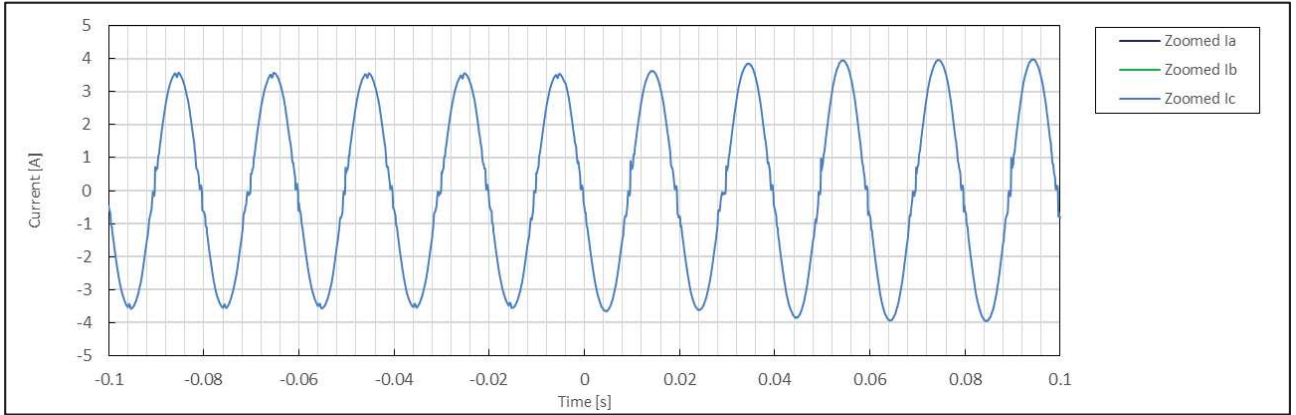

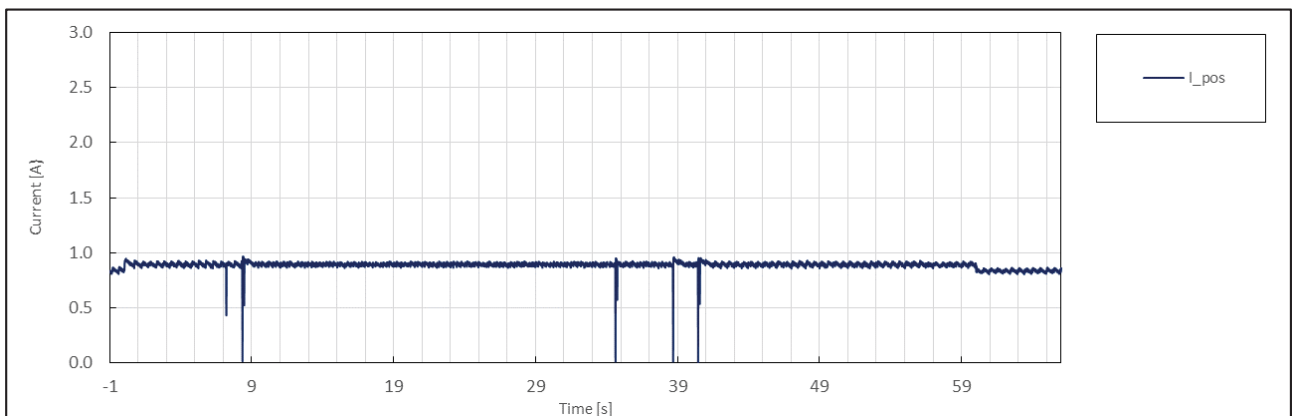
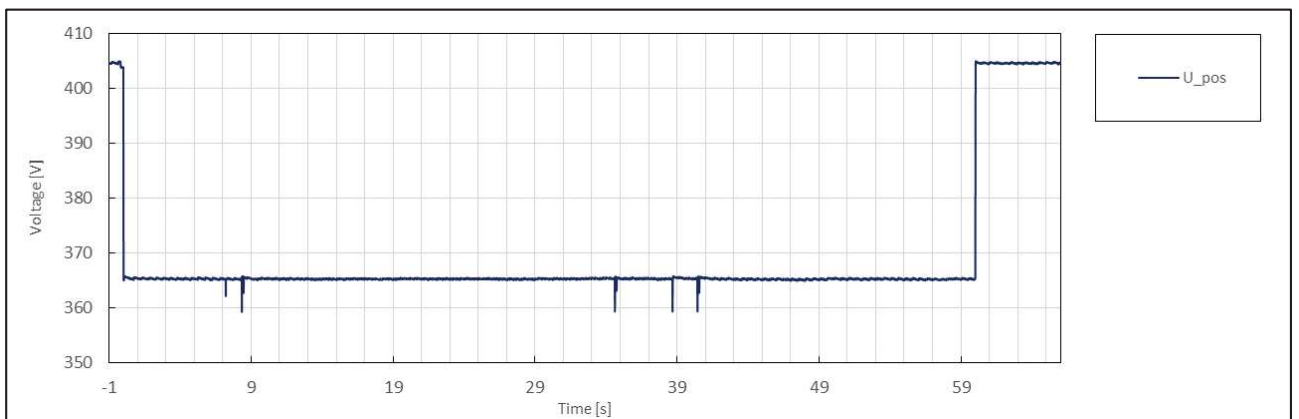
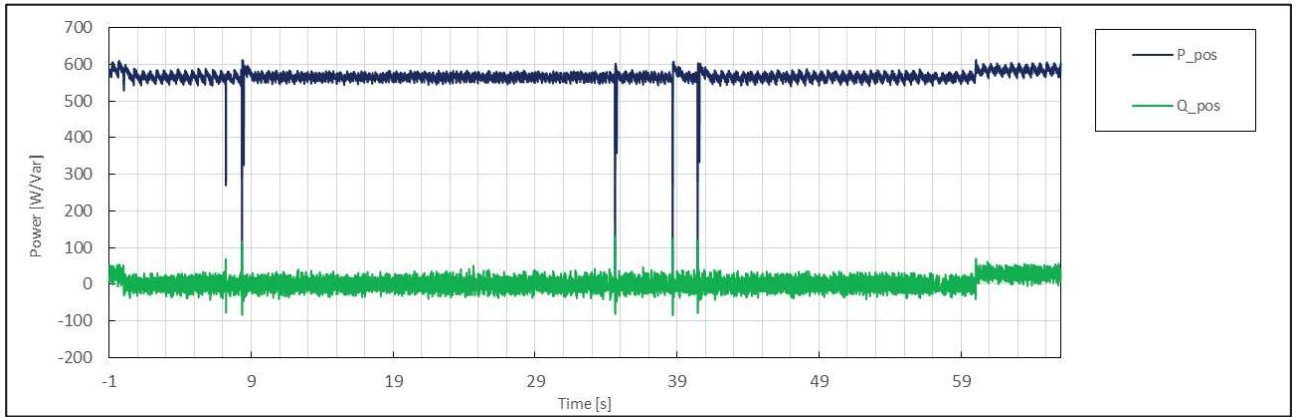

|                     | No. | Parameter  | Phase ref.      | Time ref.                       | unit       | Result        |
|---------------------|-----|--|-----------------|---------------------------------|------------|---------------|
| General Info.       | 0   | Test number  | --              | --                              | --         | 4.4           |
|                     | 1   | Date   | --              | --                              | dd.mm.yyyy | 3.1.2020      |
|                     | 2   | Time (start of test)                                   | --              | --                              | hh:mm:ss.f | 14:24:19      |
|                     | 3   | Fault type (phase)                                     | --              | --                              |            | 2-phase fault |
|                     | 4   | Setting voltage depth                                  | Line to line    | --                              | p.u.       | 0.85          |
|                     | 5   | Setting dip duration                                   |                 | --                              |            | 60030         |
|                     | 6   | Point of fault entry                                   | Total           | --                              | ms         | 0             |
|                     | 7   | Point of fault clearance                               | Total           | --                              | ms         | 60029         |
|                     | 8   | Fault duration in empty load test                      | Total           | --                              | ms         | 60030         |
|                     | 9   | Voltage depth/height in empty load test                | Total           | t1+100ms to t2 and t1-10s to t1 | p.u.       | 0.93          |
|                     | 10  |  | Pos.            |                                 | p.u.       | 0.90          |
| Before dip <t1      | 11  | Voltage  | Line to neutral | t1-100s to t1                   | p.u.       | 1.01          |
|                     | 12  | Current  | Pos.            | t1-500ms to t1-100ms            | p.u.       | 0.11          |
|                     | 13  | Active power   | Total           | t1-10s to t1                    | p.u.       | 0.33          |
|                     | 14  |  | Pos.            |                                 |            | 0.32          |
|                     | 15  | Reactive power   | Total           | t1-10s to t1                    | p.u.       | 0.04          |
|                     | 16  |  | Pos.            |                                 |            | 0.04          |
|                     | 17  | Cos $\varphi$  | --              | t1-10s to t1                    | --         | 0.994         |
| During dip t1 to t2 | 18  | Voltage  | Line to neutral | t1+100ms to t2-20ms             | p.u.       | 0.95          |
|                     | 19  | Line current   | Phase 1         | t1+60ms                         | p.u.       | N/A           |
|                     | 20  |  | Phase 2         |                                 |            | N/A           |
|                     | 21  |  | Phase 3         |                                 |            | 0.36          |
|                     | 22  | Line current   | Phase 1         | t1+100ms                        | p.u.       | N/A           |
|                     | 23  |  | Phase 2         |                                 |            | N/A           |
|                     | 24  |  | Phase 3         |                                 |            | 0.37          |
|                     | 25  | Active power   | Total           | t1+100ms to t2-20ms             | p.u.       | 0.33          |
|                     | 26  |  | Pos.            |                                 |            | 0.32          |
| After dip > t2      | 27  | Voltage  | Line to neutral | t2+3s to t2+10s                 | p.u.       | 1.01          |
|                     | 28  | Active power   | Total           | t2+3s to t2+10s                 | p.u.       | 0.33          |
|                     | 29  |  | Pos.            |                                 |            | 0.33          |
|                     | 39  | Active power rising time                               | Pos.            | --                              | s          | N/A           |
|                     | 31  | Reactive power   | Total           | t2+3s to t2+10s                 | p.u.       | 0.04          |
|                     | 32  |  | Pos.            |                                 |            | 0.04          |
|                     | 33  | Reactive power rising time                             | Pos.            | --                              | s          | N/A           |
|                     | 34  | PGU does not disconnect from grid till 60s after fault | --              | t2 to t2+60s                    | Yes / No   | No            |

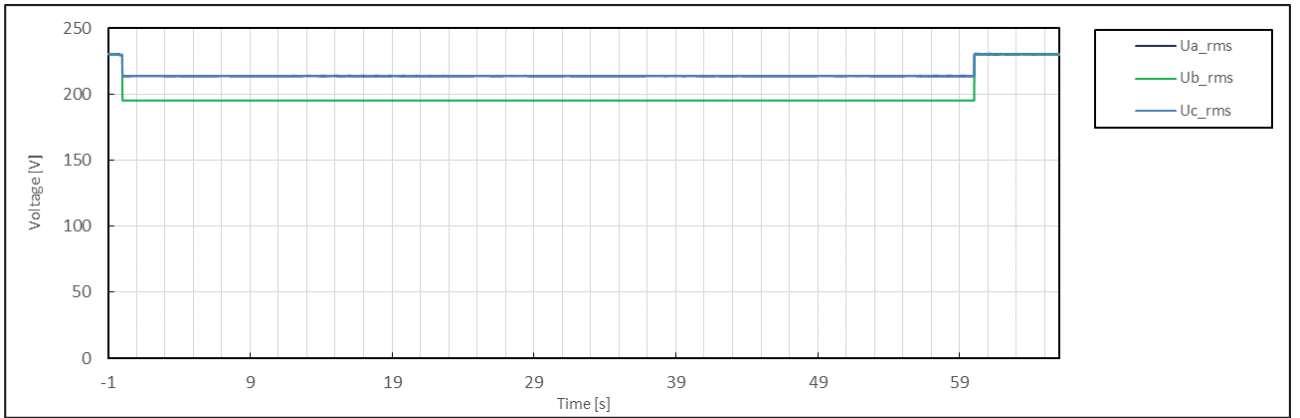
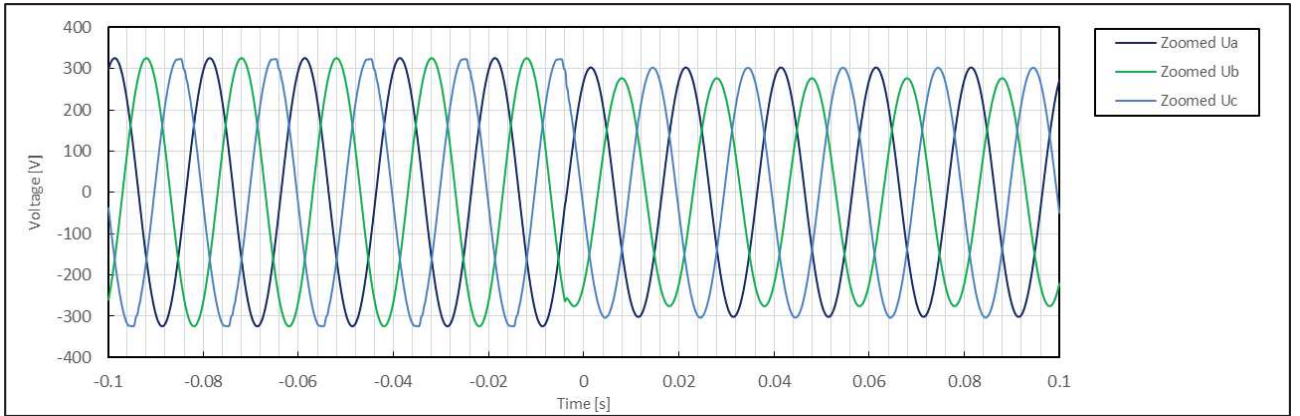
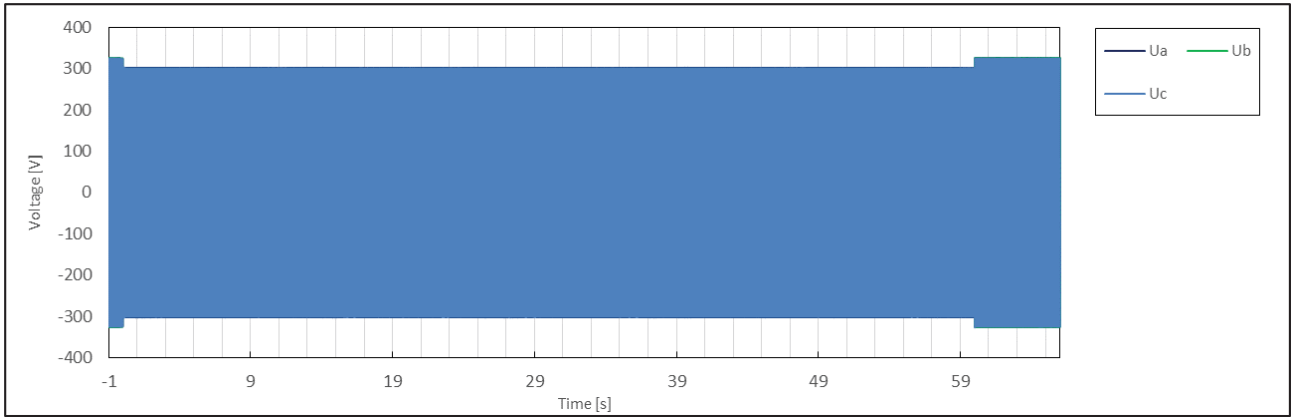

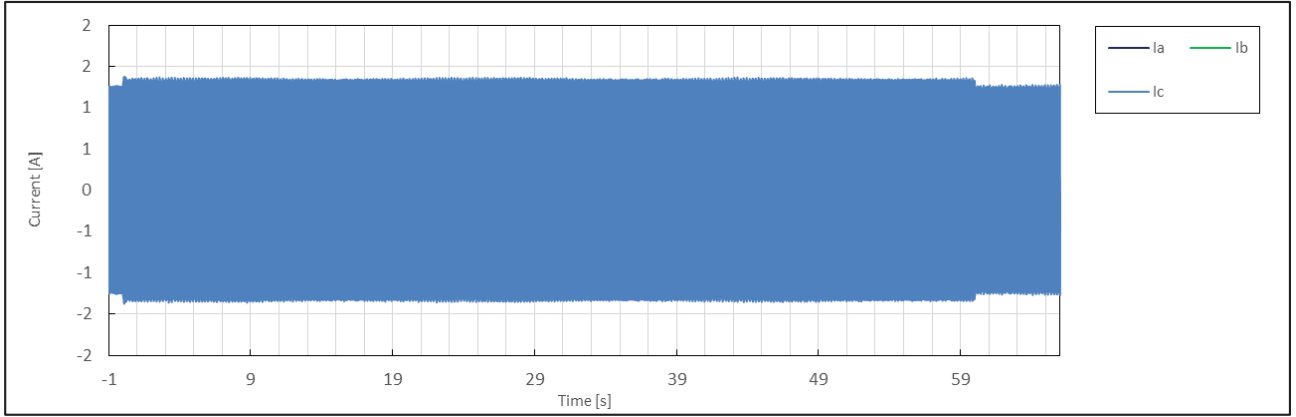
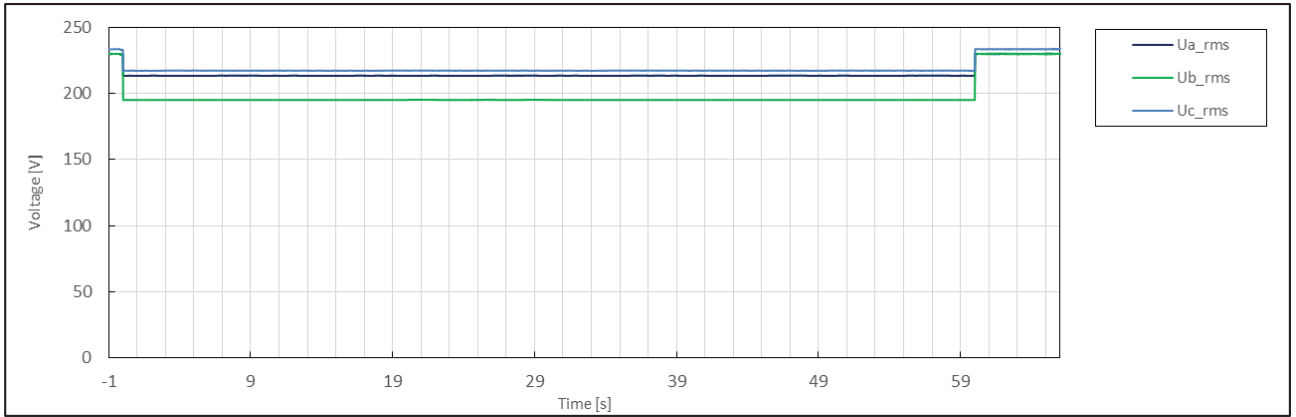
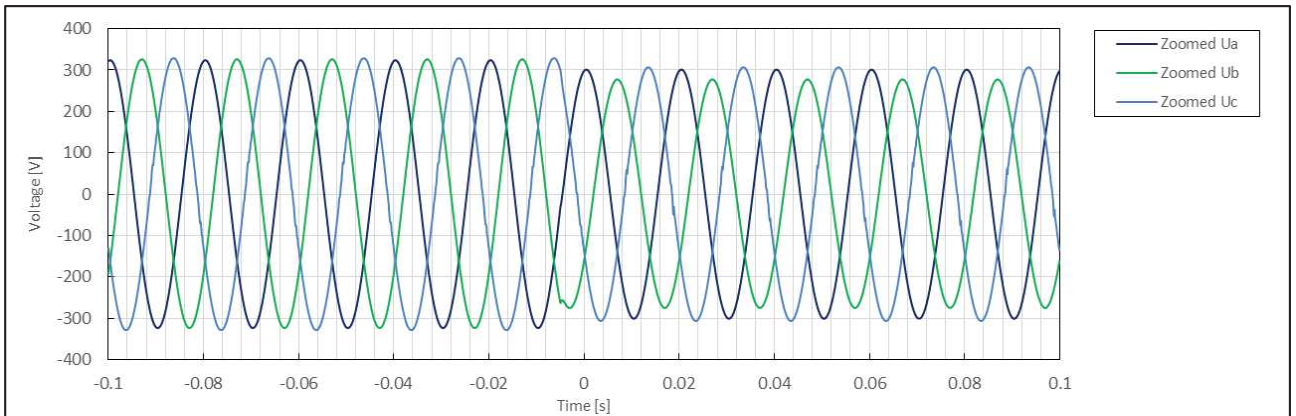
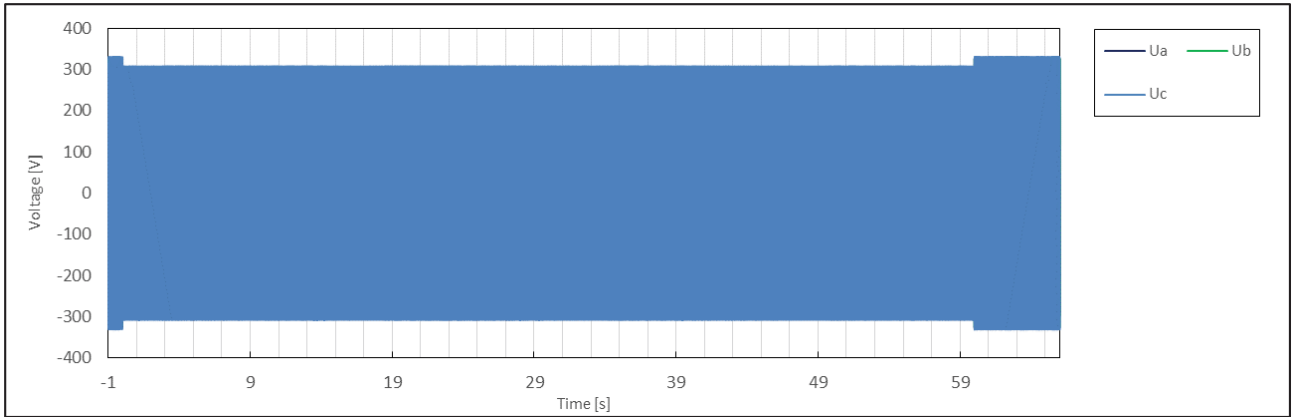



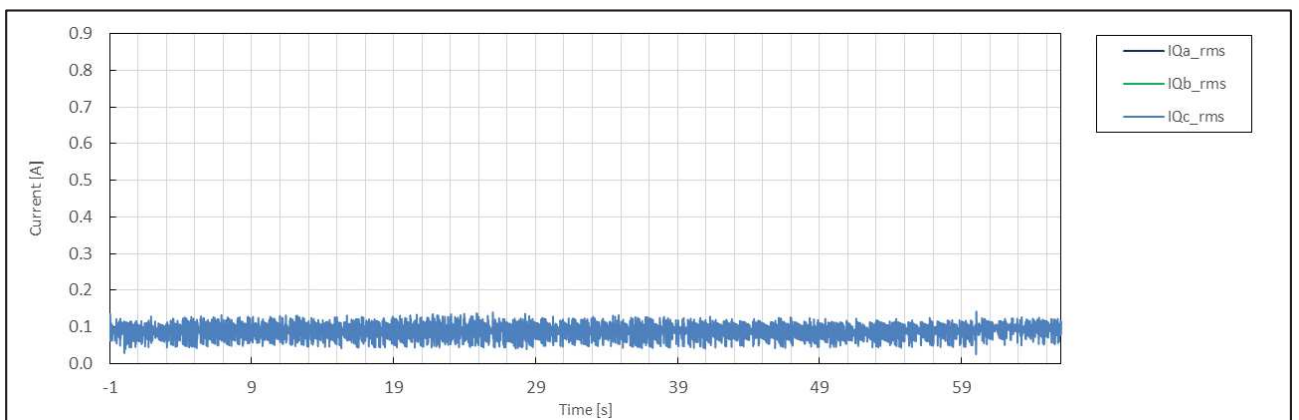
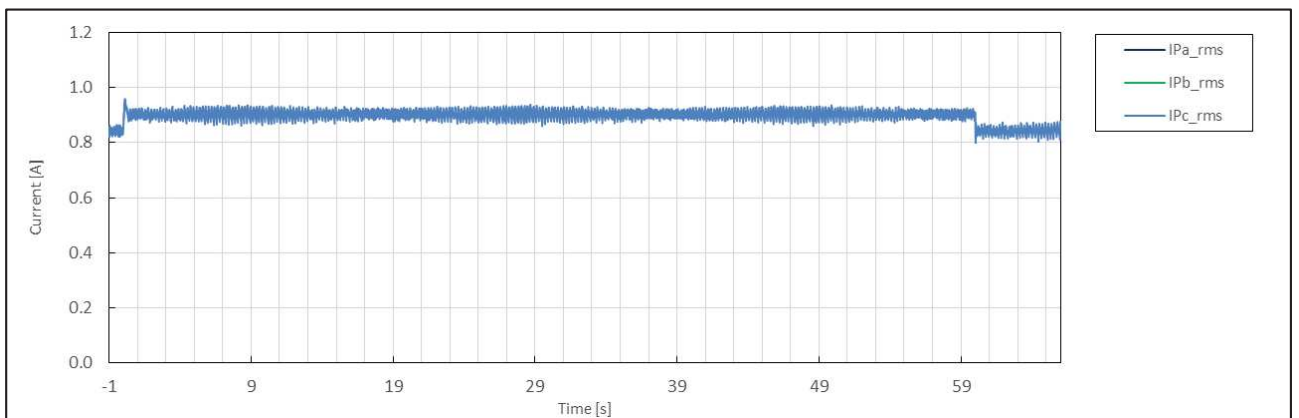
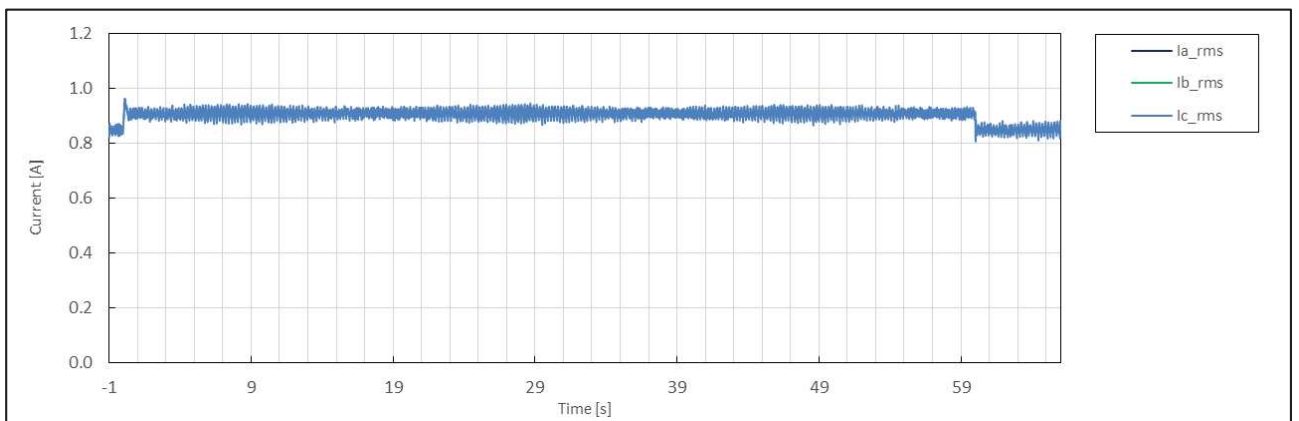
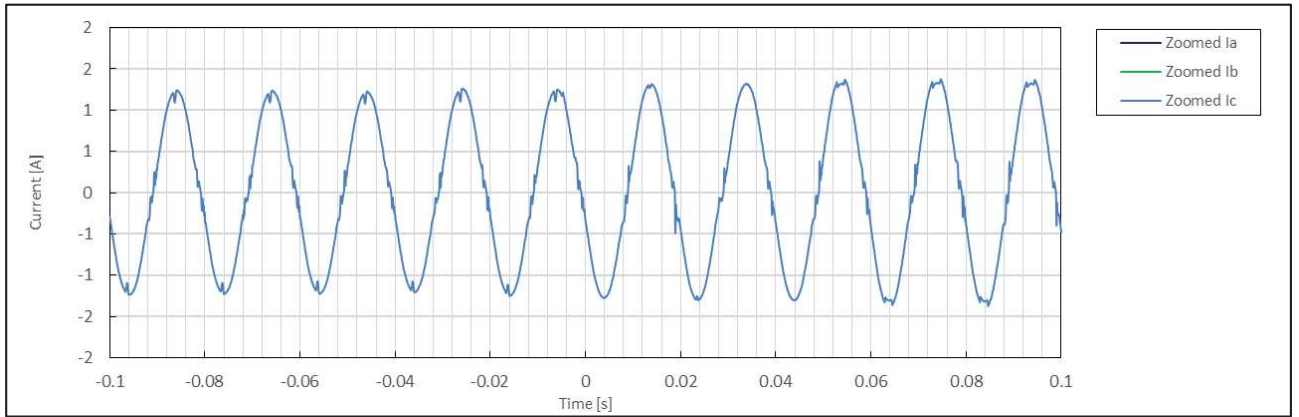

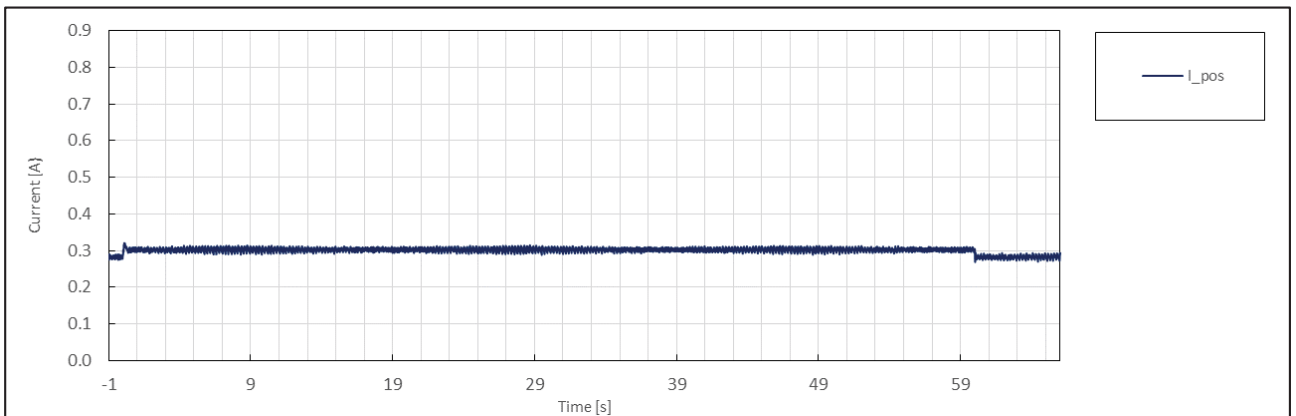
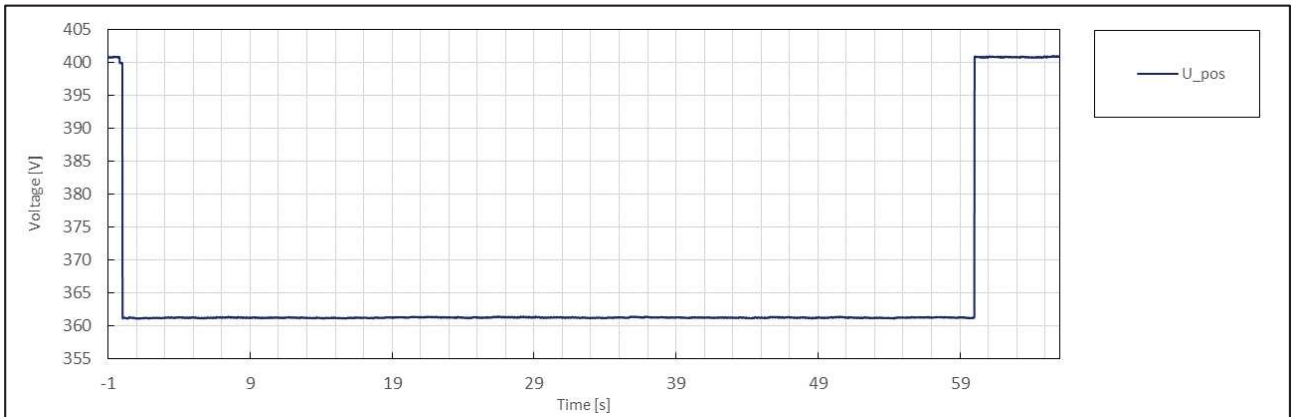
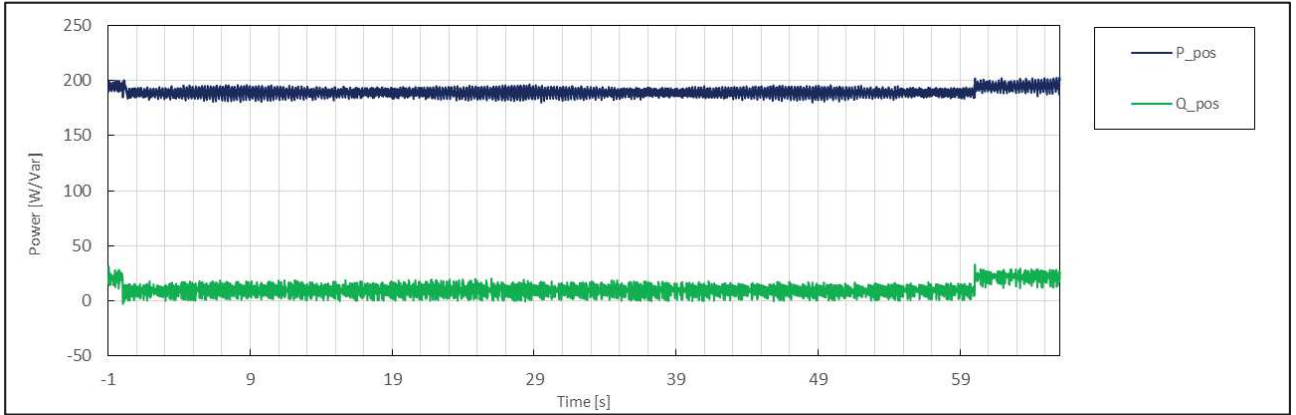

|                     | No. | Parameter  | Phase ref.      | Time ref.                       | unit       | Result        |
|---------------------|-----|--|-----------------|---------------------------------|------------|---------------|
| General Info.       | 0   | Test number  | --              | --                              | --         | 5.1           |
|                     | 1   | Date   | --              | --                              | dd.mm.yyyy | 3.1.2020      |
|                     | 2   | Time (start of test)                                   | --              | --                              | hh:mm:ss.f | 14:28:32      |
|                     | 3   | Fault type (phase)                                     | --              | --                              |            | 3-phase fault |
|                     | 4   | Setting voltage depth                                  | Line to line    | --                              | p.u.       | 1.25          |
|                     | 5   | Setting dip duration                                   |                 | --                              |            | 125           |
|                     | 6   | Point of fault entry                                   | Total           | --                              | ms         | 0             |
|                     | 7   | Point of fault clearance                               | Total           | --                              | ms         | 124           |
|                     | 8   | Fault duration in empty load test                      | Total           | --                              | ms         | 125           |
|                     | 9   | Voltage depth/height in empty load test                | Total           | t1+100ms to t2 and t1-10s to t1 | p.u.       | 1.25          |
|                     | 10  |  | Pos.            |                                 | p.u.       | 1.25          |
| Before dip <t1      | 11  | Voltage  | Line to neutral | t1-100s to t1                   | p.u.       | 1.02          |
|                     | 12  | Current  | Pos.            | t1-500ms to t1-100ms            | p.u.       | 0.32          |
|                     | 13  | Active power   | Total           | t1-10s to t1                    | p.u.       | 1.00          |
|                     | 14  |  | Pos.            |                                 |            | 0.96          |
|                     | 15  | Reactive power   | Total           | t1-10s to t1                    | p.u.       | 0.05          |
|                     | 16  |  | Pos.            |                                 |            | 0.05          |
|                     | 17  | Cos $\varphi$  | --              | t1-10s to t1                    | --         | 0.999         |
| During dip t1 to t2 | 18  | Voltage  | Line to neutral | t1+100ms to t2-20ms             | p.u.       | 1.25          |
|                     | 19  | Line current   | Phase 1         | t1+60ms                         | p.u.       | N/A           |
|                     | 20  |  | Phase 2         |                                 |            | N/A           |
|                     | 21  |  | Phase 3         |                                 |            | 0.03          |
|                     | 22  | Line current   | Phase 1         | t1+100ms                        | p.u.       | N/A           |
|                     | 23  |  | Phase 2         |                                 |            | N/A           |
|                     | 24  |  | Phase 3         |                                 |            | 0.03          |
|                     | 25  | Active power   | Total           | t1+100ms to t2-20ms             | p.u.       | 0.01          |
|                     | 26  |  | Pos.            |                                 |            | -0.01         |
| After dip > t2      | 27  | Voltage  | Line to neutral | t2+3s to t2+10s                 | p.u.       | 1.02          |
|                     | 28  | Active power   | Total           | t2+3s to t2+10s                 | p.u.       | 1.00          |
|                     | 29  |  | Pos.            |                                 |            | 0.97          |
|                     | 39  | Active power rising time                               | Pos.            | --                              | s          | 0.838         |
|                     | 31  | Reactive power   | Total           | t2+3s to t2+10s                 | p.u.       | 0.04          |
|                     | 32  |  | Pos.            |                                 |            | 0.05          |
|                     | 33  | Reactive power rising time                             | Pos.            | --                              | s          | N/A           |
|                     | 34  | PGU does not disconnect from grid till 60s after fault | --              | t2 to t2+60s                    | Yes / No   | No            |

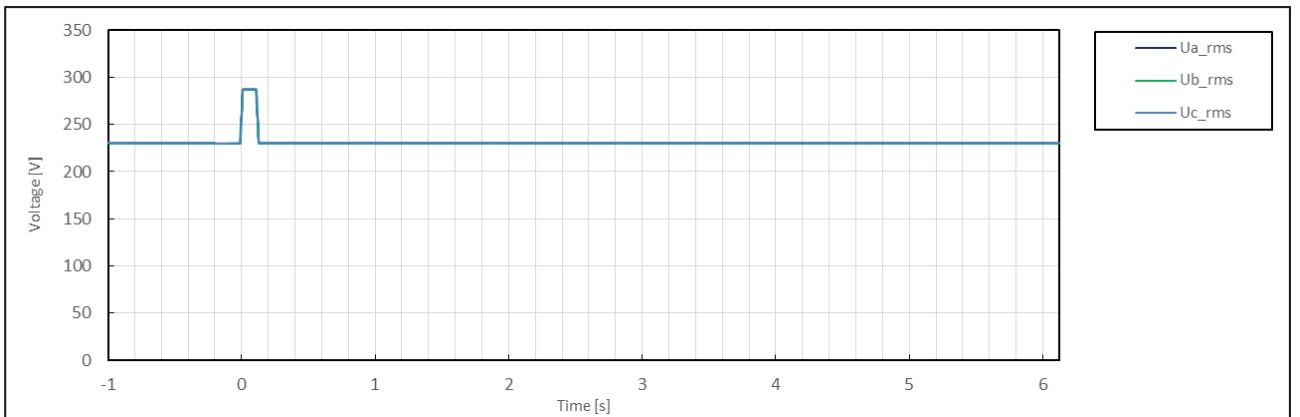
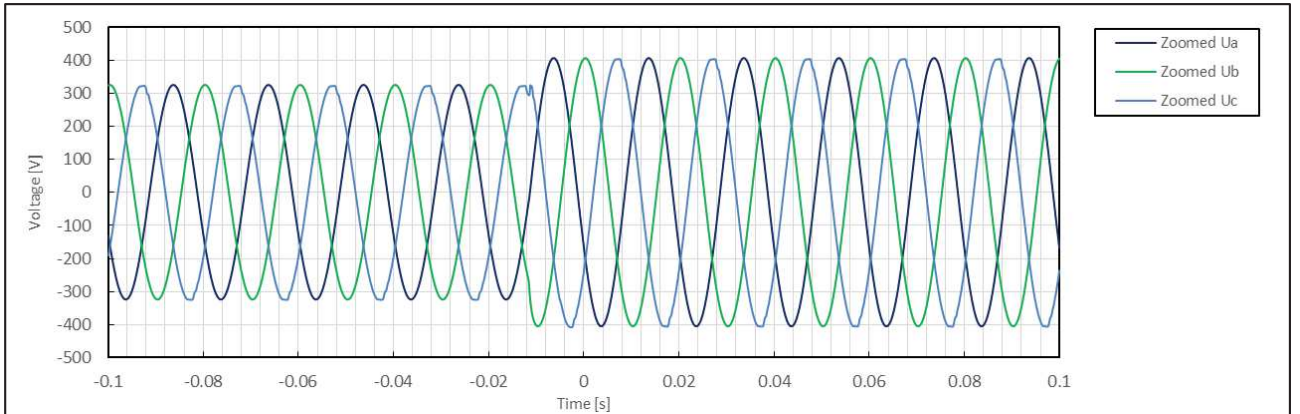
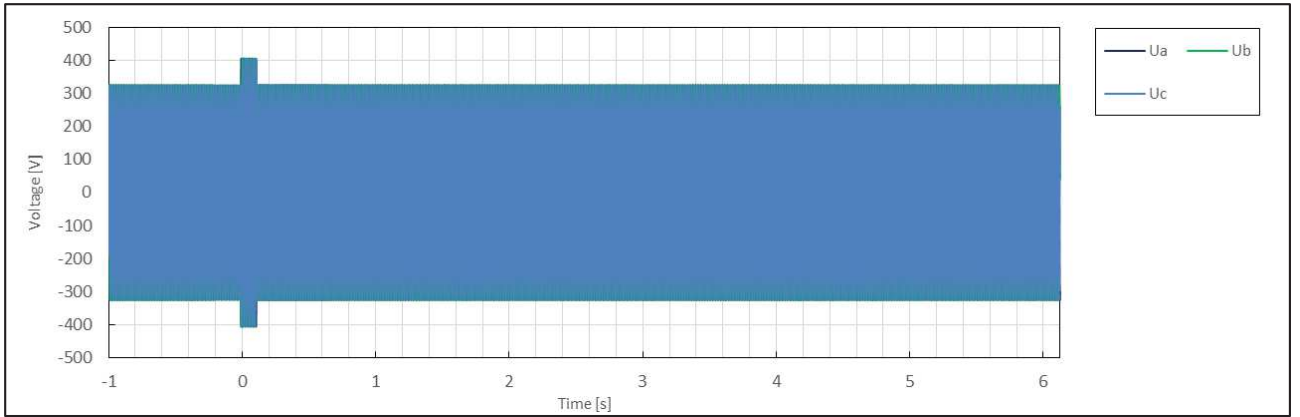

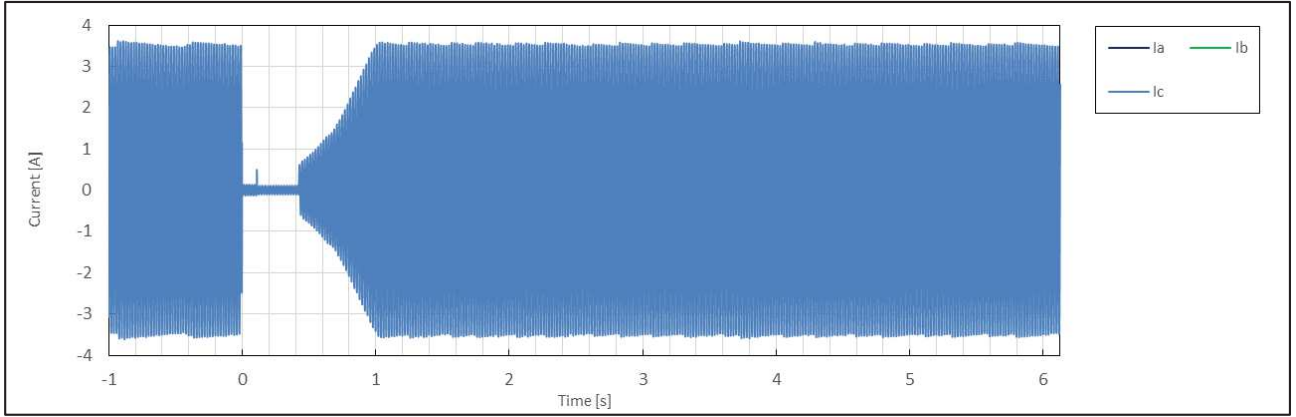
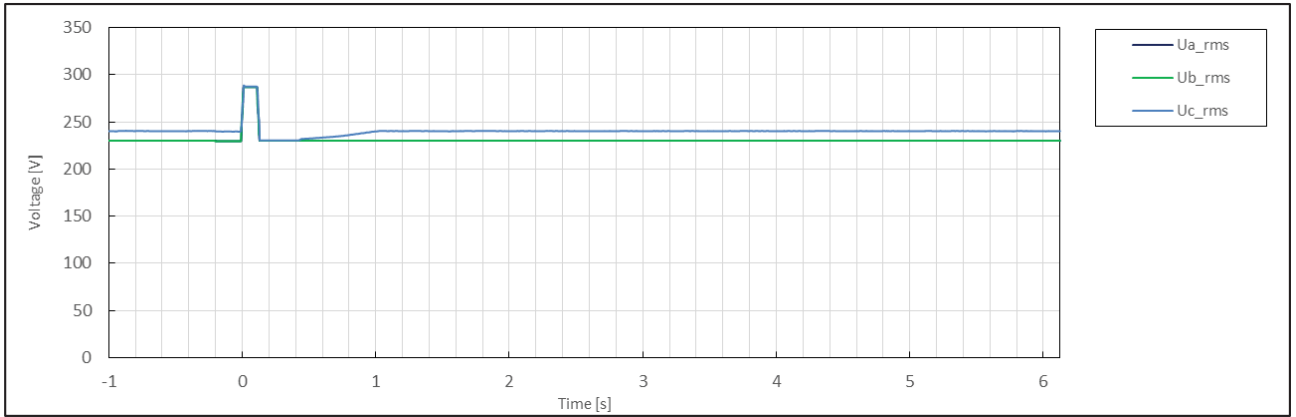
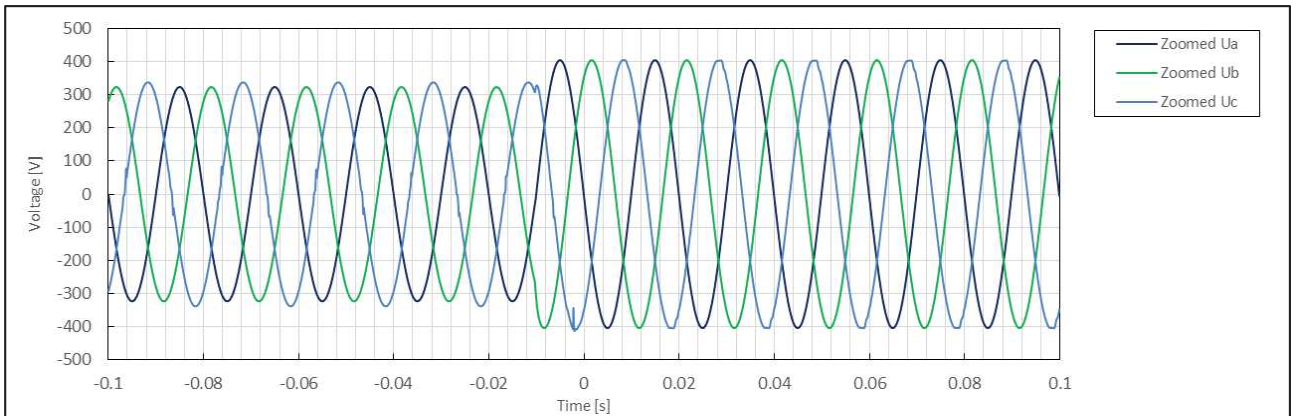
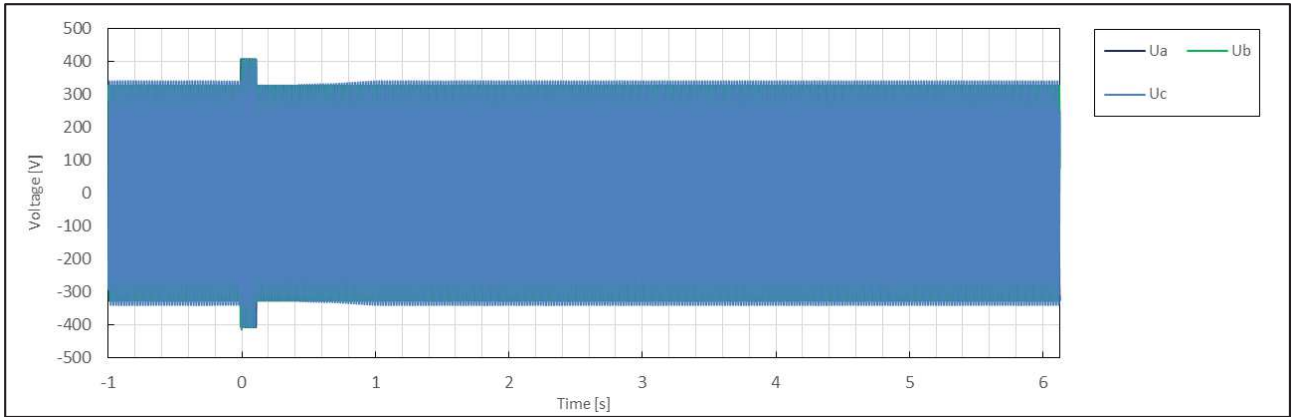

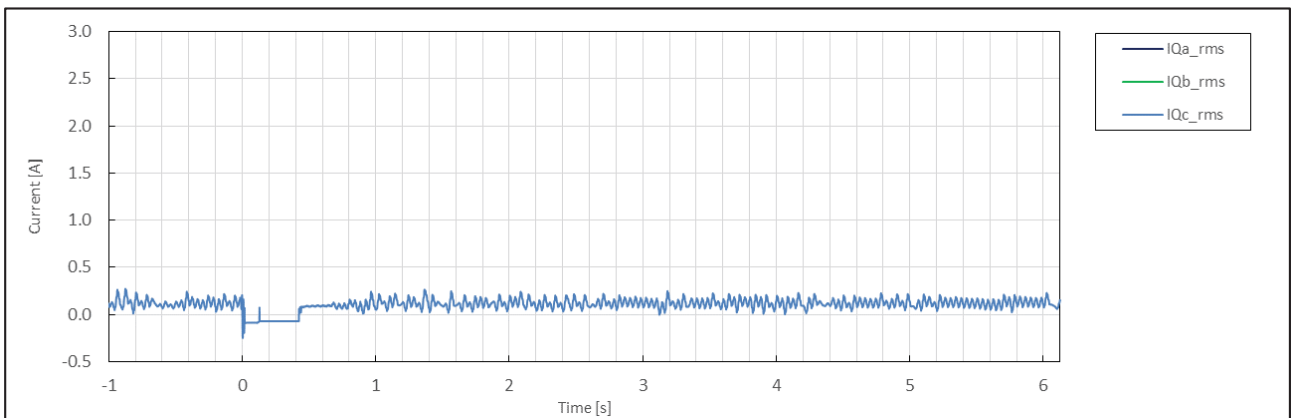
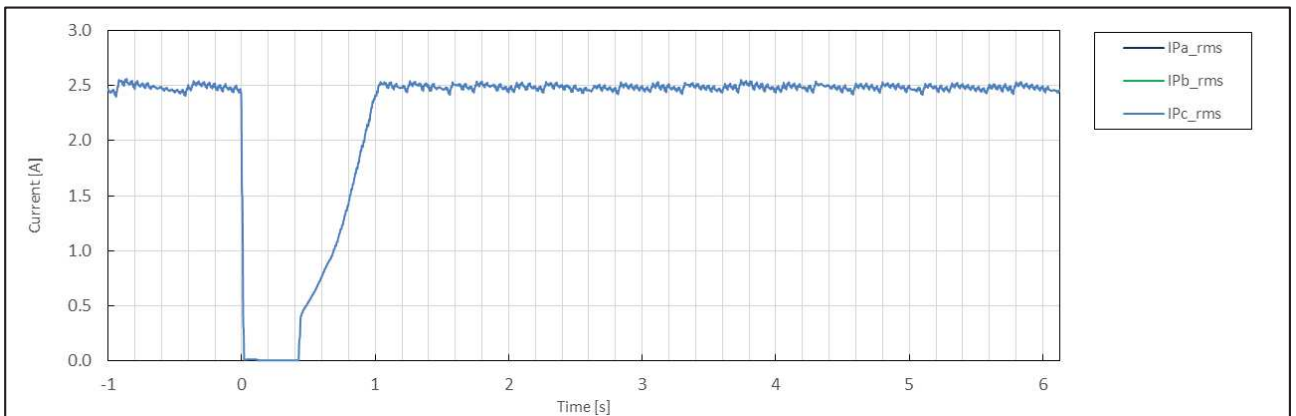
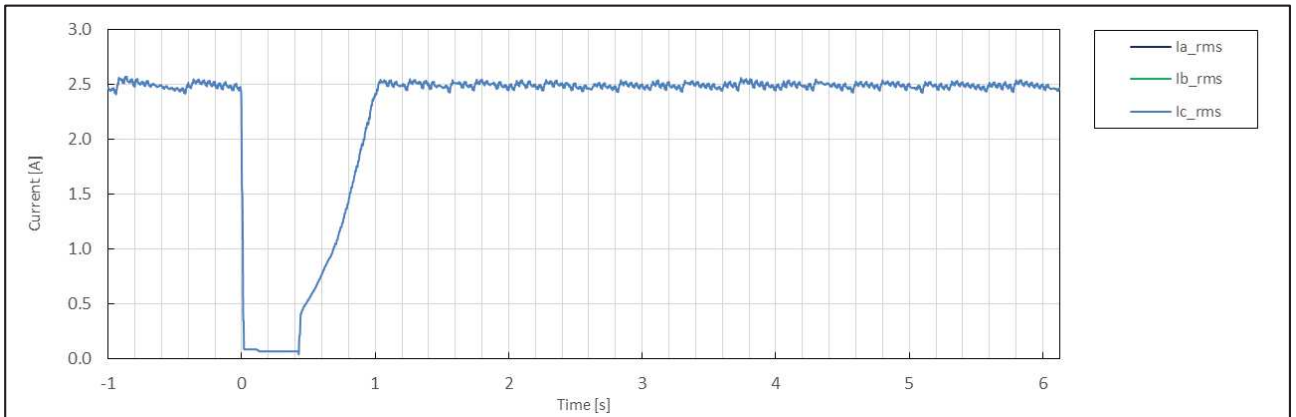
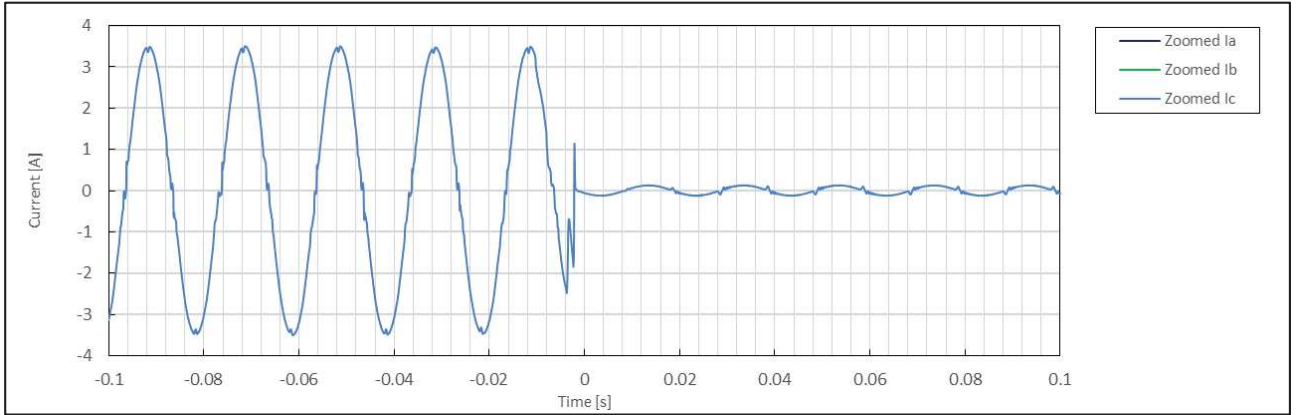

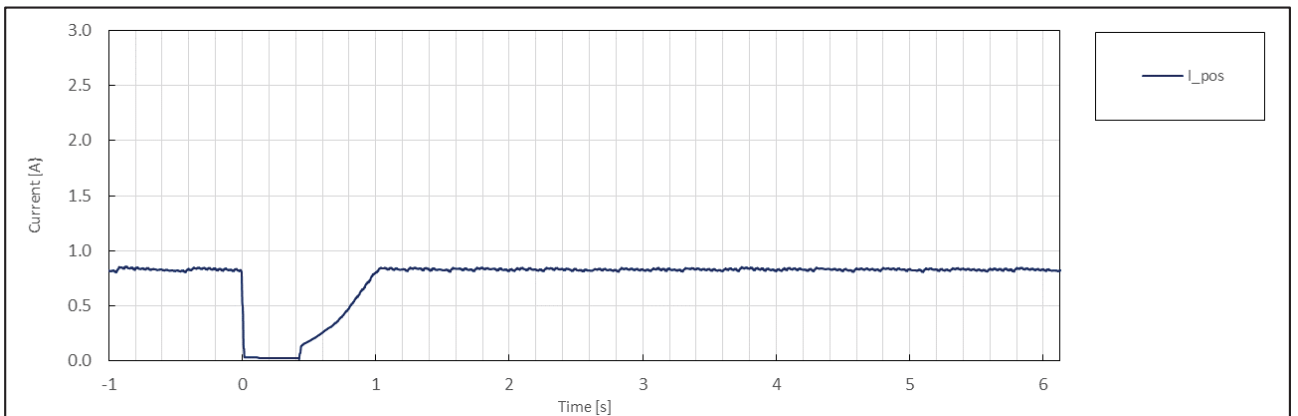
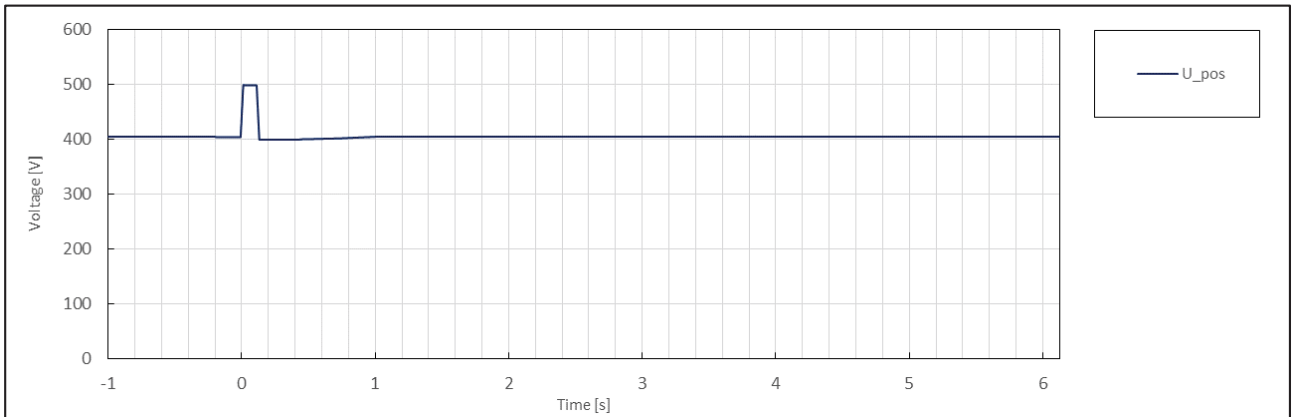
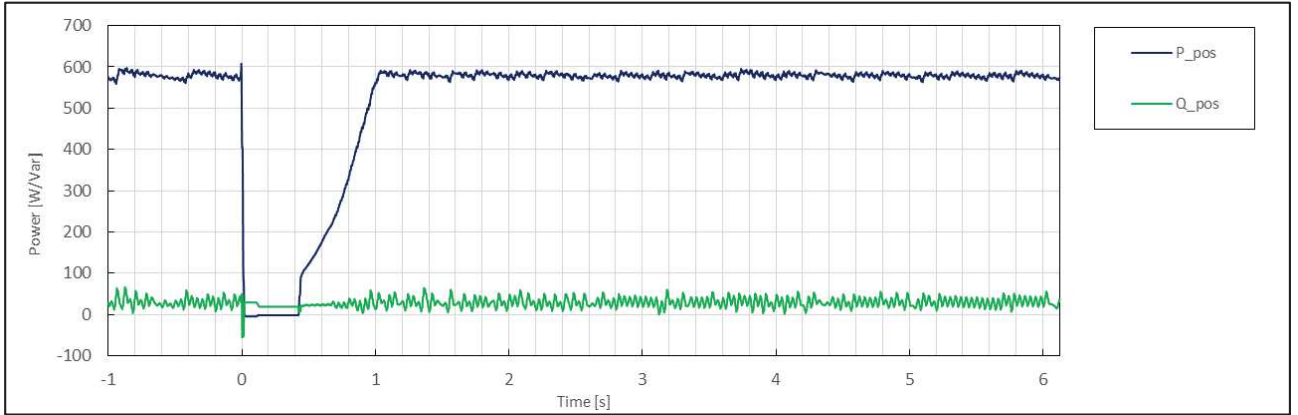

|                     | No. | Parameter  | Phase ref.      | Time ref.                       | unit       | Result        |
|---------------------|-----|--|-----------------|---------------------------------|------------|---------------|
| General Info.       | 0   | Test number  | --              | --                              | --         | 5.2           |
|                     | 1   | Date   | --              | --                              | dd.mm.yyyy | 3.1.2020      |
|                     | 2   | Time (start of test)                                   | --              | --                              | hh:mm:ss.f | 14:33:18      |
|                     | 3   | Fault type (phase)                                     | --              | --                              |            | 3-phase fault |
|                     | 4   | Setting voltage depth                                  | Line to line    | --                              | p.u.       | 1.25          |
|                     | 5   | Setting dip duration                                   |                 | --                              |            | 125           |
|                     | 6   | Point of fault entry                                   | Total           | --                              | ms         | 0             |
|                     | 7   | Point of fault clearance                               | Total           | --                              | ms         | 124           |
|                     | 8   | Fault duration in empty load test                      | Total           | --                              | ms         | 125           |
|                     | 9   | Voltage depth/height in empty load test                | Total           | t1+100ms to t2 and t1-10s to t1 | p.u.       | 1.25          |
|                     | 10  |  | Pos.            |                                 | p.u.       | 1.25          |
| Before dip <t1      | 11  | Voltage  | Line to neutral | t1-100s to t1                   | p.u.       | 1.01          |
|                     | 12  | Current  | Pos.            | t1-500ms to t1-100ms            | p.u.       | 0.16          |
|                     | 13  | Active power   | Total           | t1-10s to t1                    | p.u.       | 0.49          |
|                     | 14  |  | Pos.            |                                 |            | 0.48          |
|                     | 15  | Reactive power   | Total           | t1-10s to t1                    | p.u.       | 0.04          |
|                     | 16  |  | Pos.            |                                 |            | 0.04          |
|                     | 17  | Cos $\varphi$  | --              | t1-10s to t1                    | --         | 0.997         |
| During dip t1 to t2 | 18  | Voltage  | Line to neutral | t1+100ms to t2-20ms             | p.u.       | 1.25          |
|                     | 19  | Line current   | Phase 1         | t1+60ms                         | p.u.       | N/A           |
|                     | 20  |  | Phase 2         |                                 |            | N/A           |
|                     | 21  |  | Phase 3         |                                 |            | 0.03          |
|                     | 22  | Line current   | Phase 1         | t1+100ms                        | p.u.       | N/A           |
|                     | 23  |  | Phase 2         |                                 |            | N/A           |
|                     | 24  |  | Phase 3         |                                 |            | 0.03          |
|                     | 25  | Active power   | Total           | t1+100ms to t2-20ms             | p.u.       | 0.01          |
|                     | 26  |  | Pos.            |                                 |            | -0.01         |
| After dip > t2      | 27  | Voltage  | Line to neutral | t2+3s to t2+10s                 | p.u.       | 1.01          |
|                     | 28  | Active power   | Total           | t2+3s to t2+10s                 | p.u.       | 0.49          |
|                     | 29  |  | Pos.            |                                 |            | 0.48          |
|                     | 39  | Active power rising time                               | Pos.            | --                              | s          | 0.604         |
|                     | 31  | Reactive power   | Total           | t2+3s to t2+10s                 | p.u.       | 0.03          |
|                     | 32  |  | Pos.            |                                 |            | 0.04          |
|                     | 33  | Reactive power rising time                             | Pos.            | --                              | s          | N/A           |
|                     | 34  | PGU does not disconnect from grid till 60s after fault | --              | t2 to t2+60s                    | Yes / No   | No            |



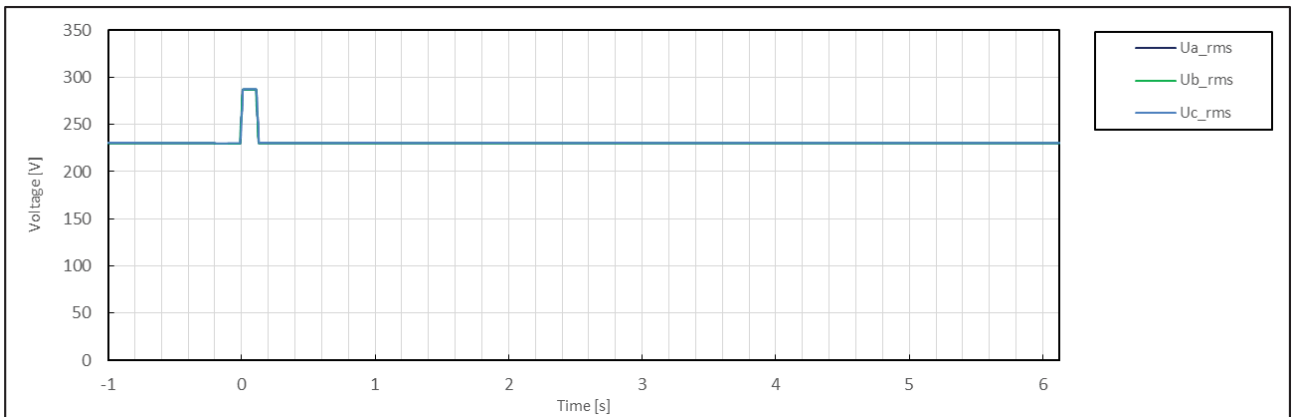
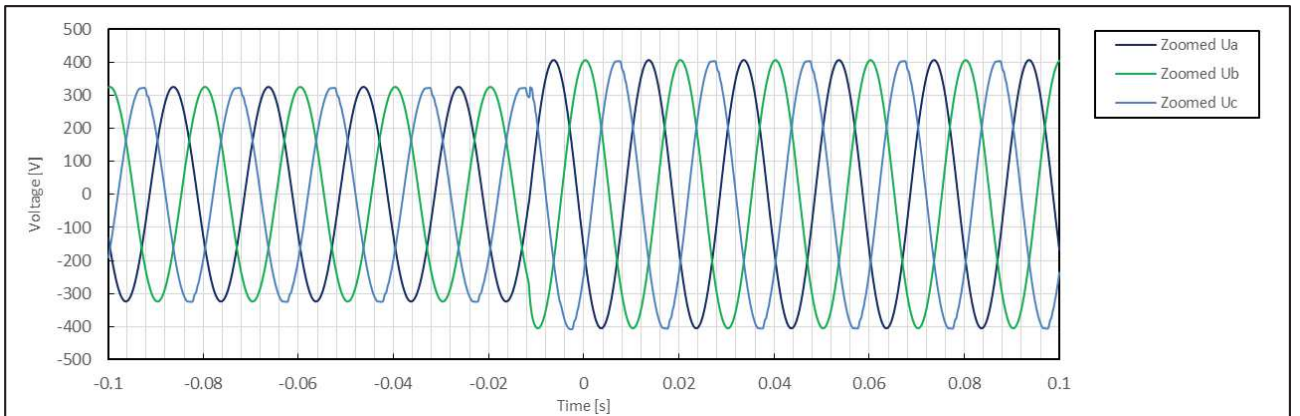
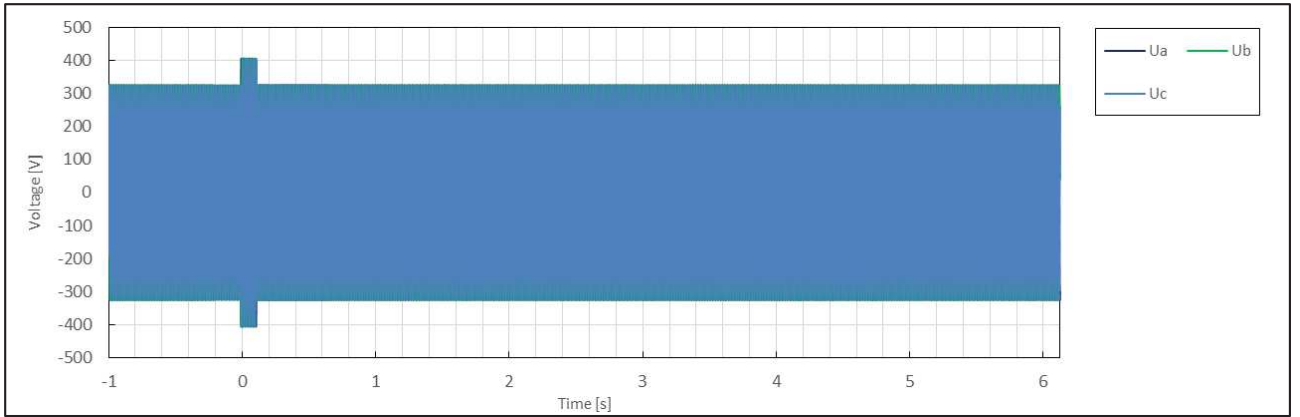

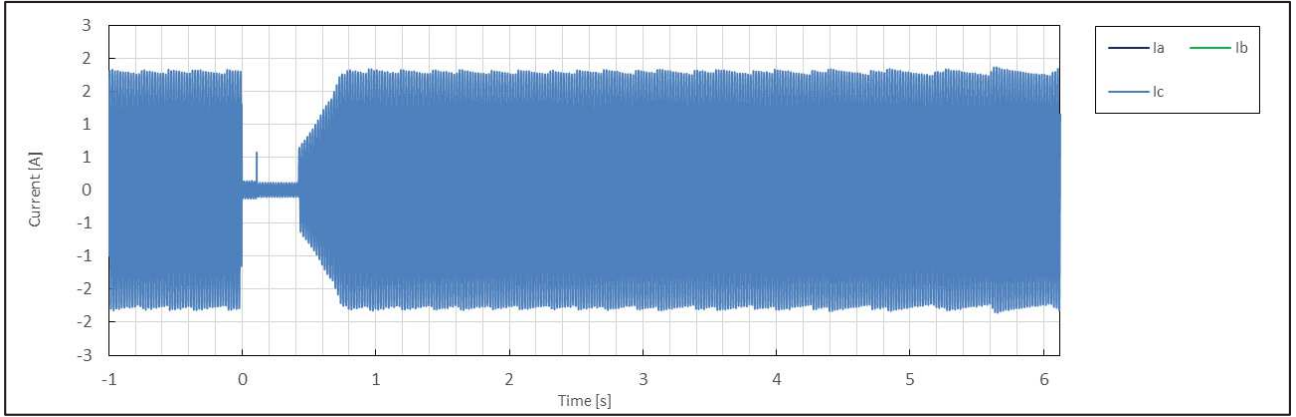
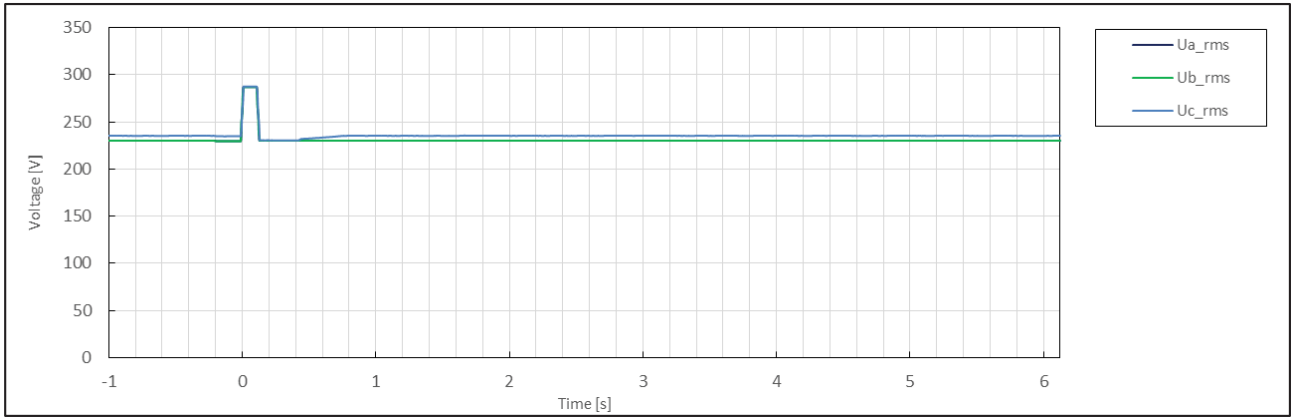
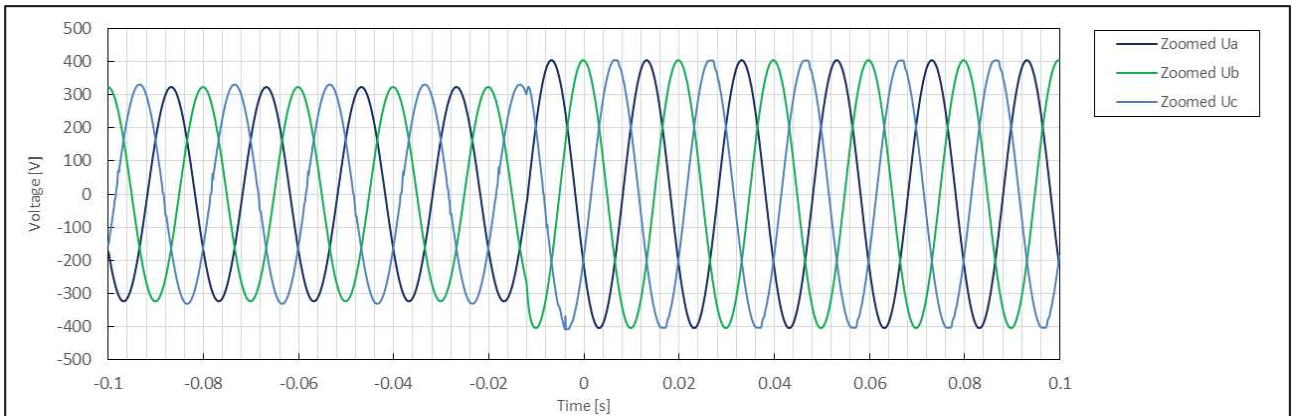
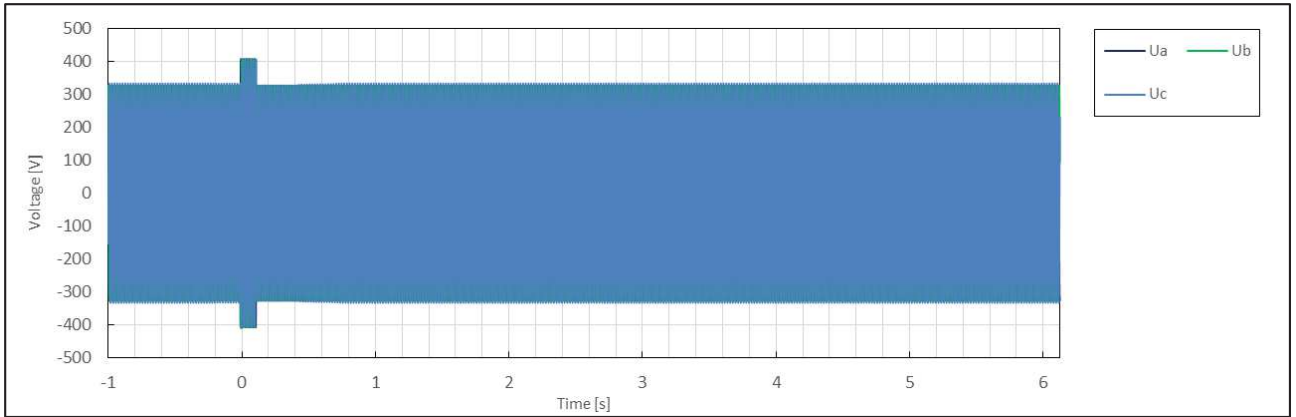

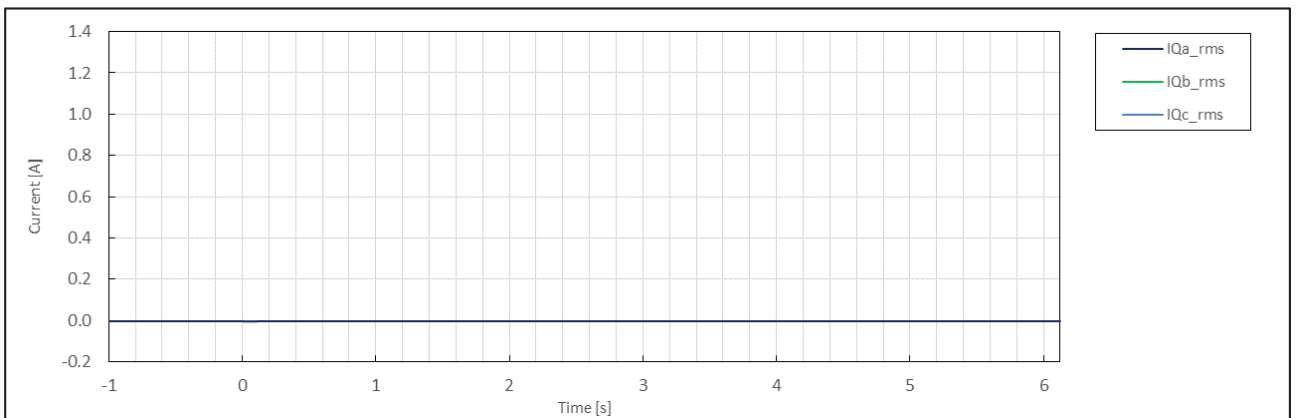
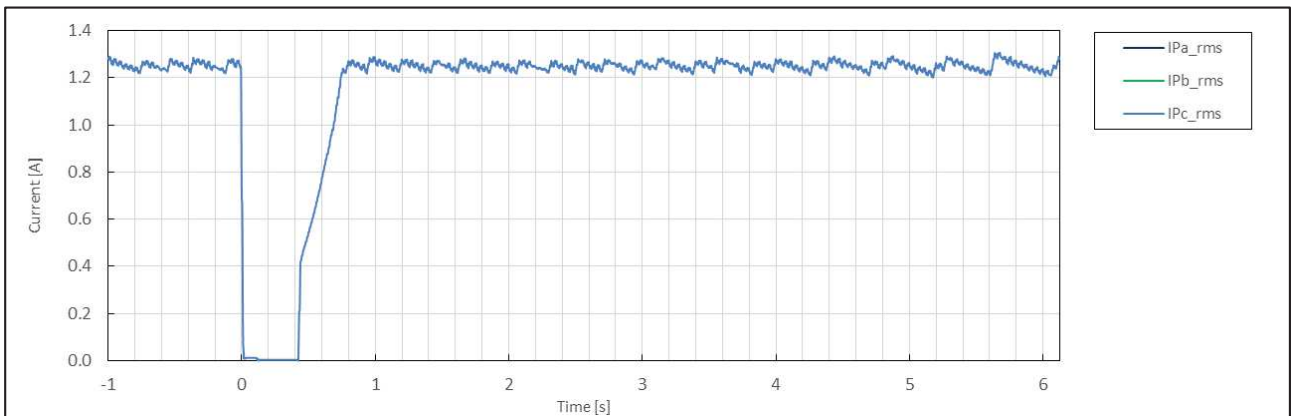
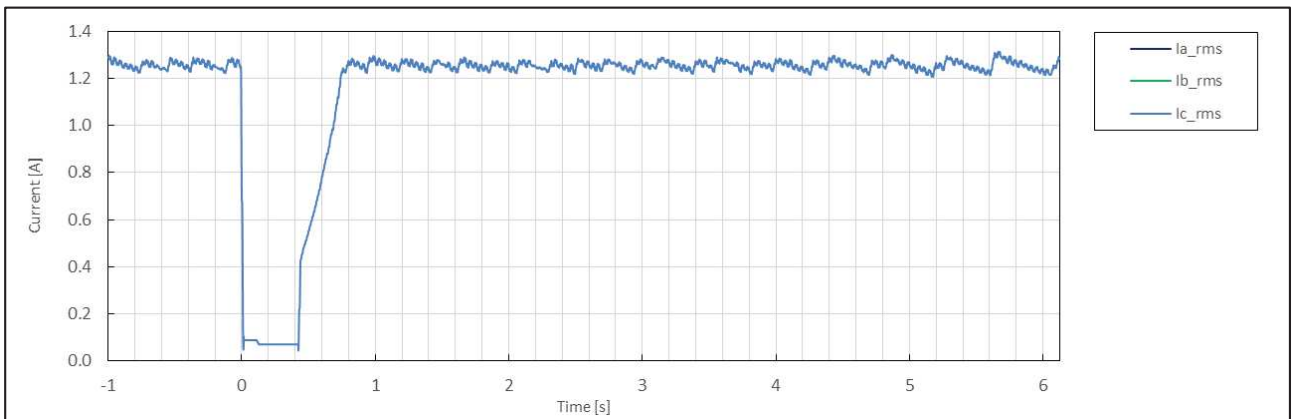
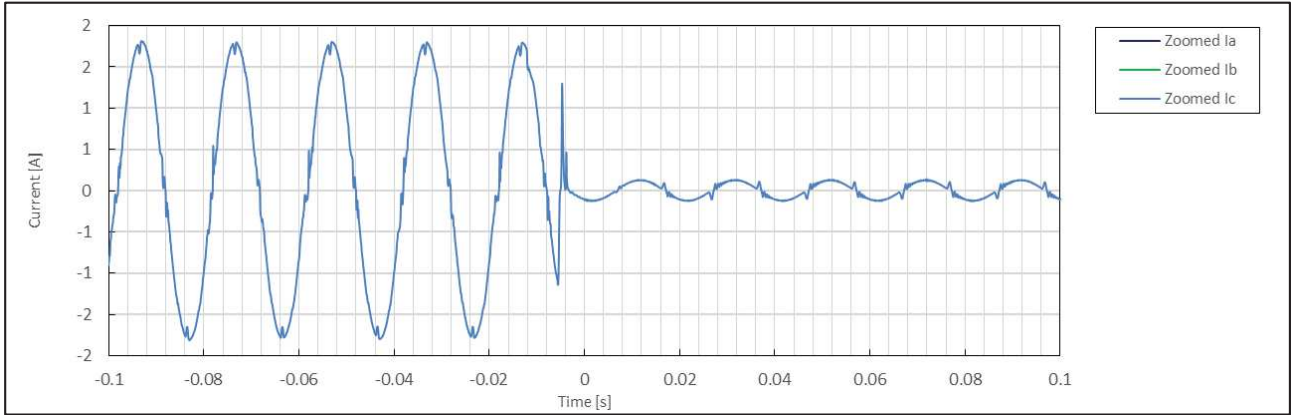

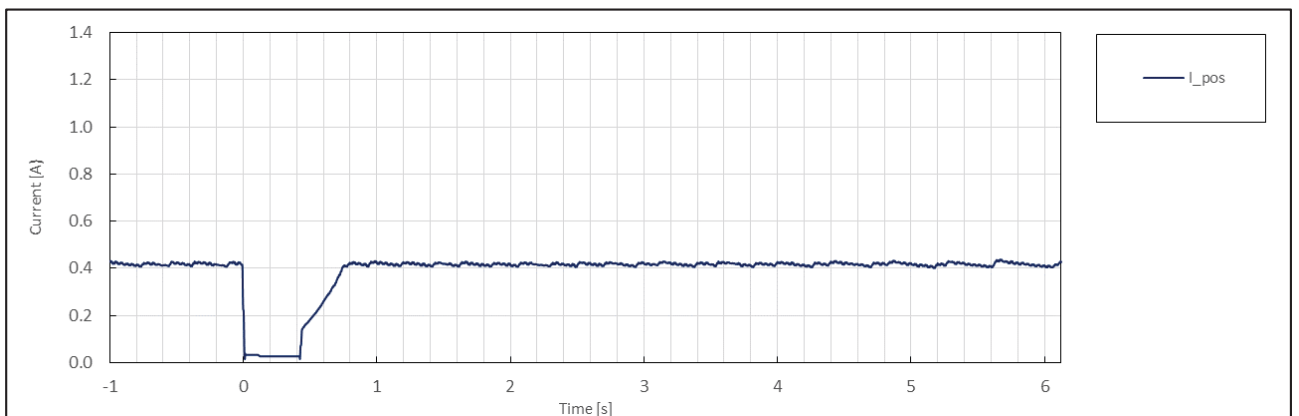
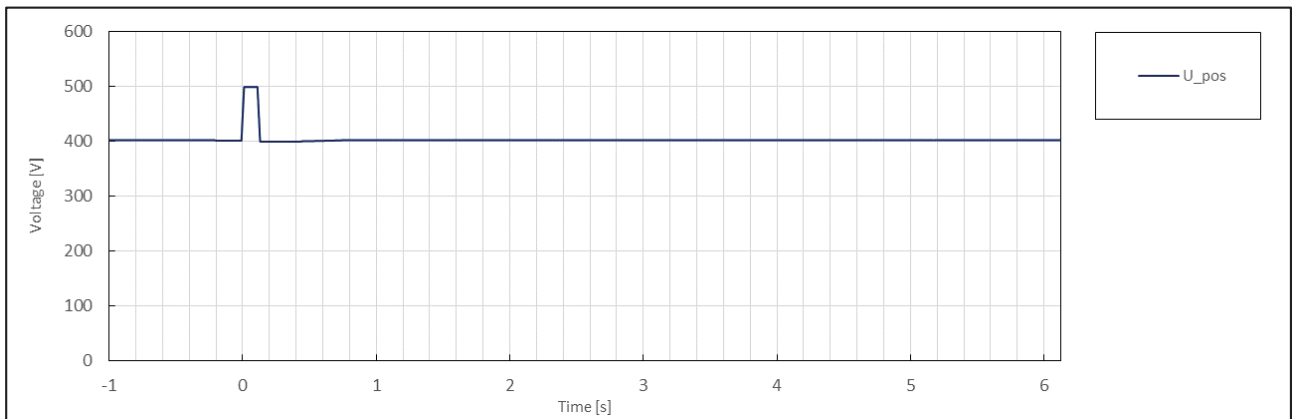
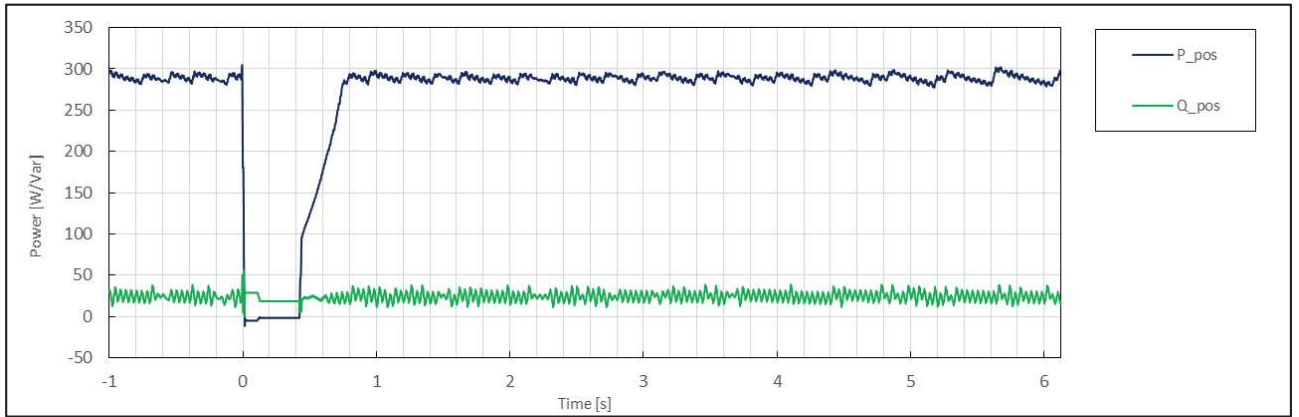

|                     | No. | Parameter  | Phase ref.      | Time ref.                       | unit       | Result        |
|---------------------|-----|--|-----------------|---------------------------------|------------|---------------|
| General Info.       | 0   | Test number  | --              | --                              | --         | 5.3           |
|                     | 1   | Date   | --              | --                              | dd.mm.yyyy | 3.1.2020      |
|                     | 2   | Time (start of test)                                   | --              | --                              | hh:mm:ss.f | 14:38:19      |
|                     | 3   | Fault type (phase)                                     | --              | --                              |            | 2-phase fault |
|                     | 4   | Setting voltage depth                                  | Line to line    | --                              | p.u.       | 1.25          |
|                     | 5   | Setting dip duration                                   |                 | --                              |            | 121           |
|                     | 6   | Point of fault entry                                   | Total           | --                              | ms         | 0             |
|                     | 7   | Point of fault clearance                               | Total           | --                              | ms         | 120           |
|                     | 8   | Fault duration in empty load test                      | Total           | --                              | ms         | 121           |
|                     | 9   | Voltage depth/height in empty load test                | Total           | t1+100ms to t2 and t1-10s to t1 | p.u.       | 1.06          |
|                     | 10  |  | Pos.            |                                 | p.u.       | 1.12          |
| Before dip <t1      | 11  | Voltage  | Line to neutral | t1-100s to t1                   | p.u.       | 1.02          |
|                     | 12  | Current  | Pos.            | t1-500ms to t1-100ms            | p.u.       | 0.32          |
|                     | 13  | Active power   | Total           | t1-10s to t1                    | p.u.       | 1.01          |
|                     | 14  |  | Pos.            |                                 |            | 0.98          |
|                     | 15  | Reactive power   | Total           | t1-10s to t1                    | p.u.       | 0.05          |
|                     | 16  |  | Pos.            |                                 |            | 0.05          |
|                     | 17  | Cos $\varphi$  | --              | t1-10s to t1                    | --         | 0.999         |
| During dip t1 to t2 | 18  | Voltage  | Line to neutral | t1+100ms to t2-20ms             | p.u.       | 1.10          |
|                     | 19  | Line current   | Phase 1         | t1+60ms                         | p.u.       | N/A           |
|                     | 20  |  | Phase 2         |                                 |            | N/A           |
|                     | 21  |  | Phase 3         |                                 |            | 0.82          |
|                     | 22  | Line current   | Phase 1         | t1+100ms                        | p.u.       | N/A           |
|                     | 23  |  | Phase 2         |                                 |            | N/A           |
|                     | 24  |  | Phase 3         |                                 |            | 0.86          |
|                     | 25  | Active power   | Total           | t1+100ms to t2-20ms             | p.u.       | 0.94          |
|                     | 26  |  | Pos.            |                                 |            | 0.97          |
| After dip > t2      | 27  | Voltage  | Line to neutral | t2+3s to t2+10s                 | p.u.       | 1.02          |
|                     | 28  | Active power   | Total           | t2+3s to t2+10s                 | p.u.       | 1.01          |
|                     | 29  |  | Pos.            |                                 |            | 0.98          |
|                     | 39  | Active power rising time                               | Pos.            | --                              | s          | N/A           |
|                     | 31  | Reactive power   | Total           | t2+3s to t2+10s                 | p.u.       | 0.05          |
|                     | 32  |  | Pos.            |                                 |            | 0.05          |
|                     | 33  | Reactive power rising time                             | Pos.            | --                              | s          | N/A           |
|                     | 34  | PGU does not disconnect from grid till 60s after fault | --              | t2 to t2+60s                    | Yes / No   | No            |

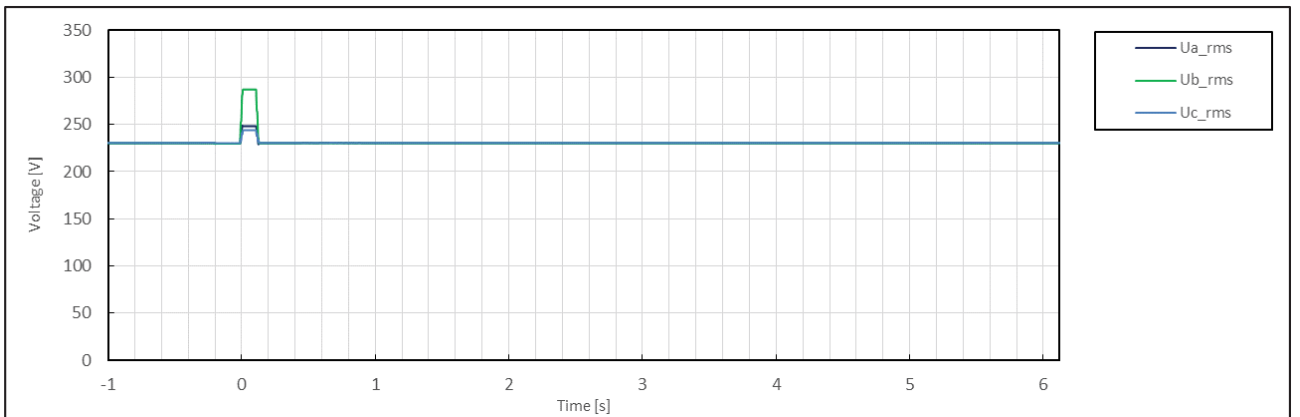
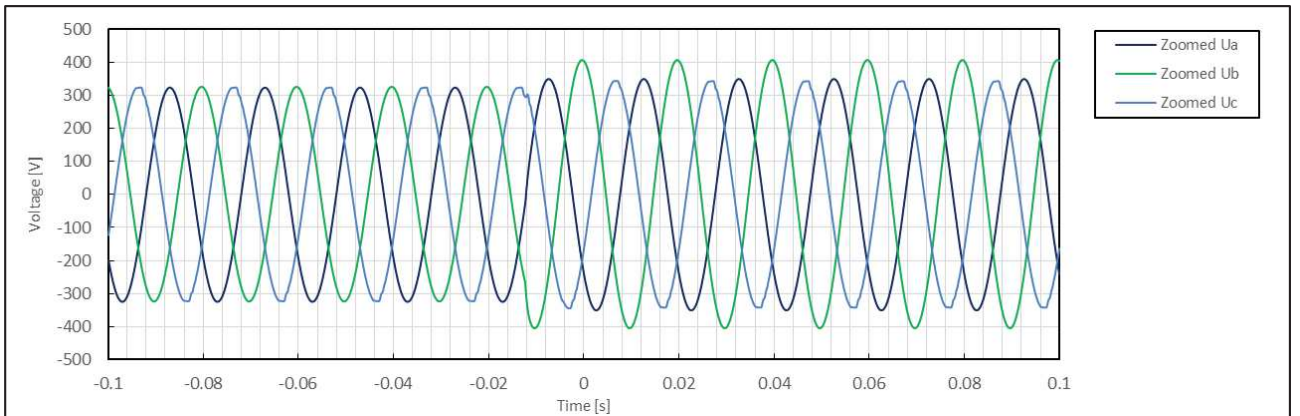
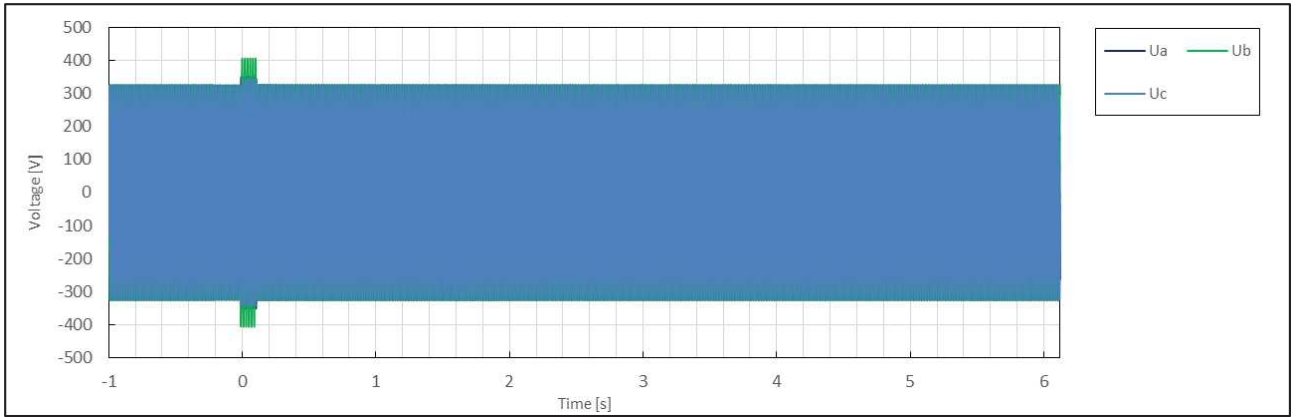

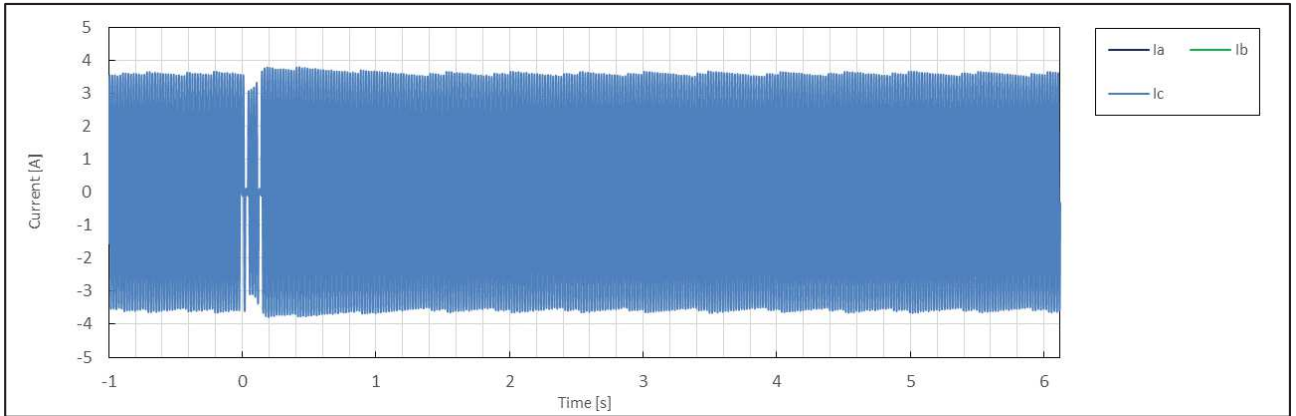
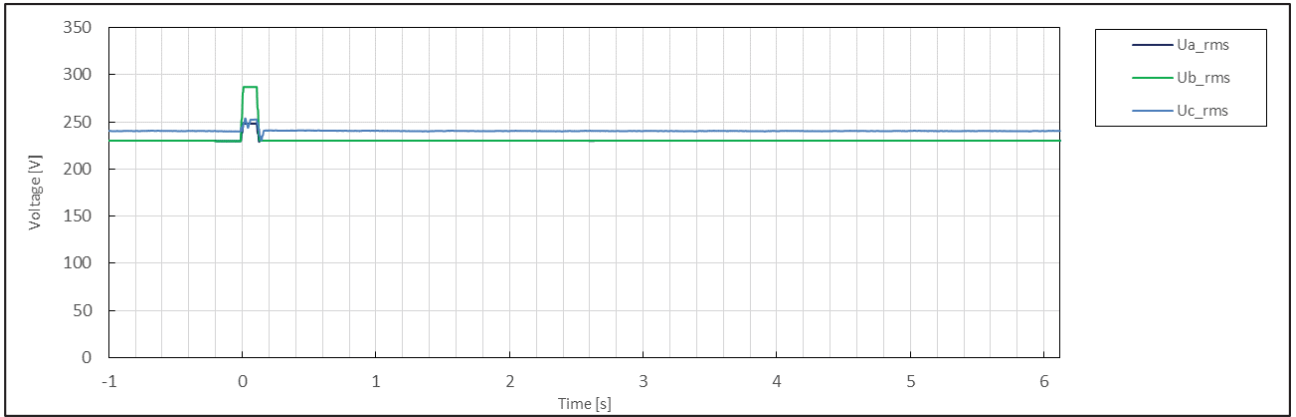
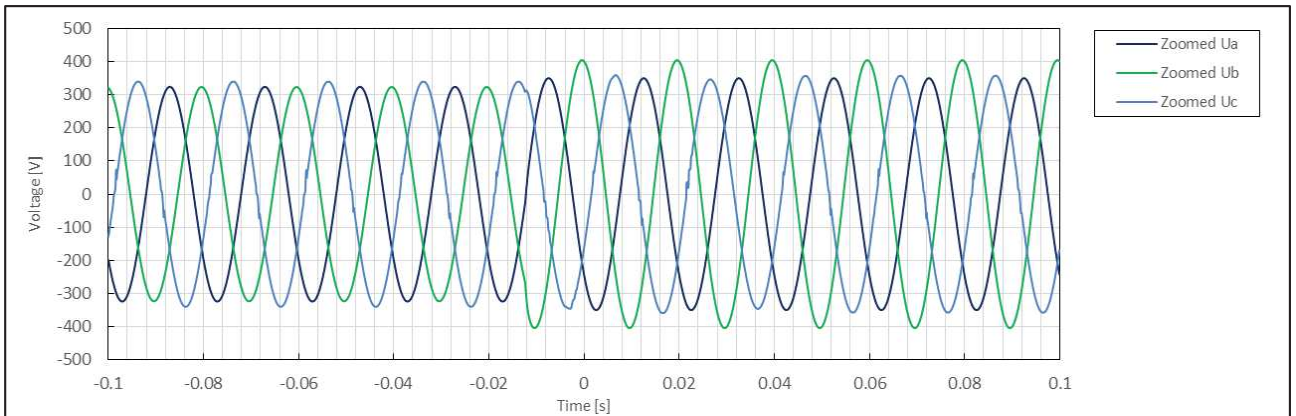
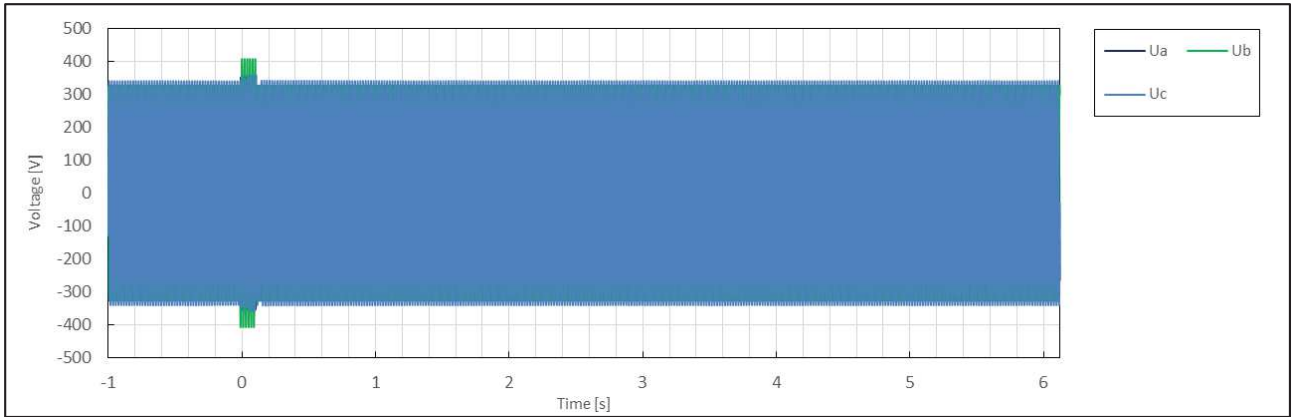



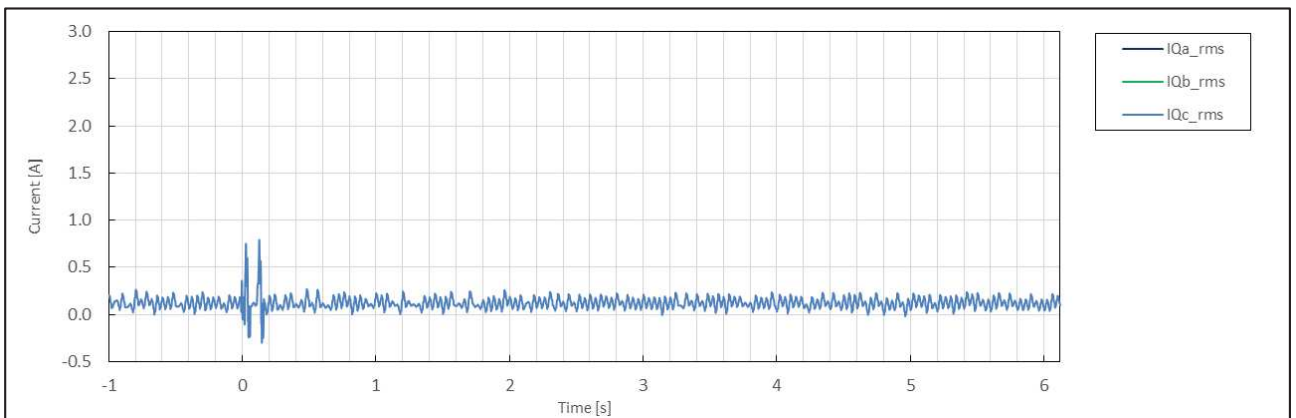
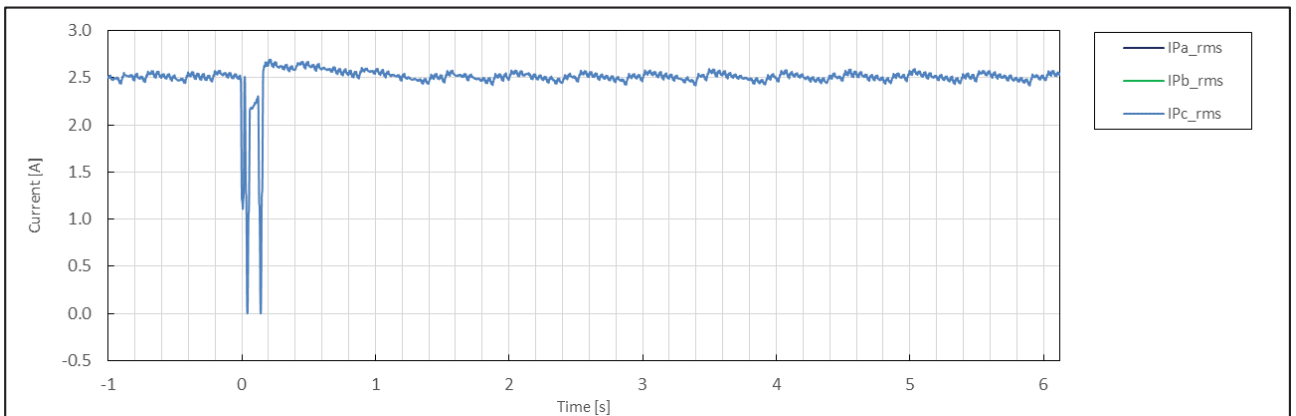
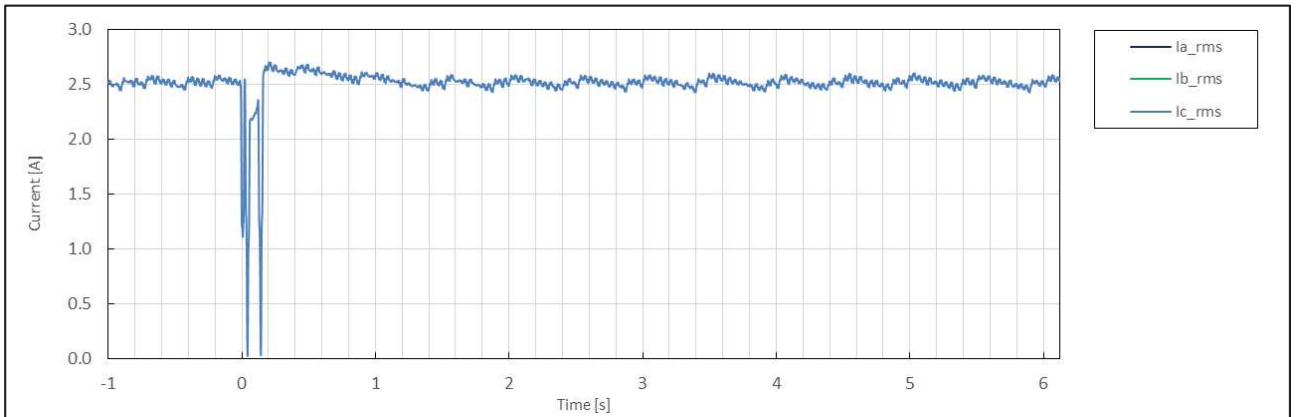
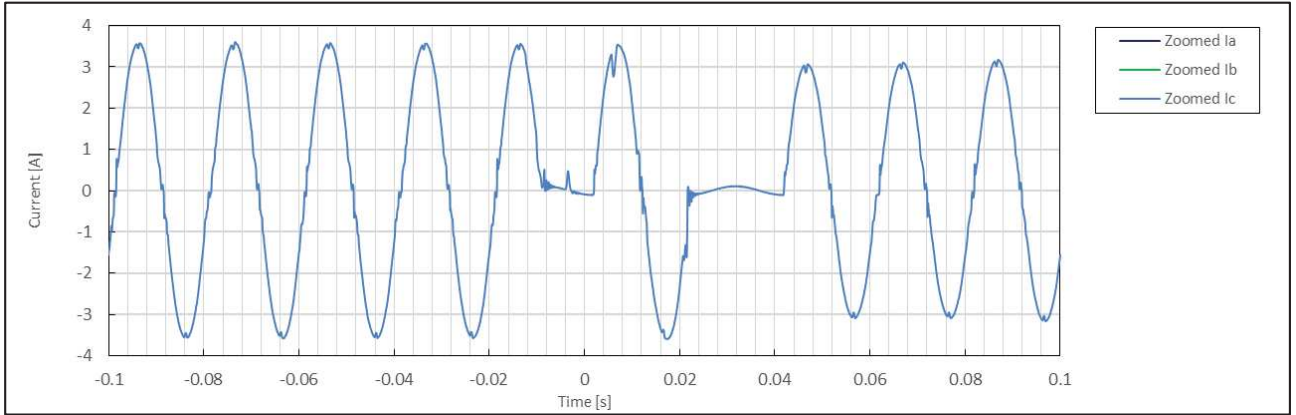



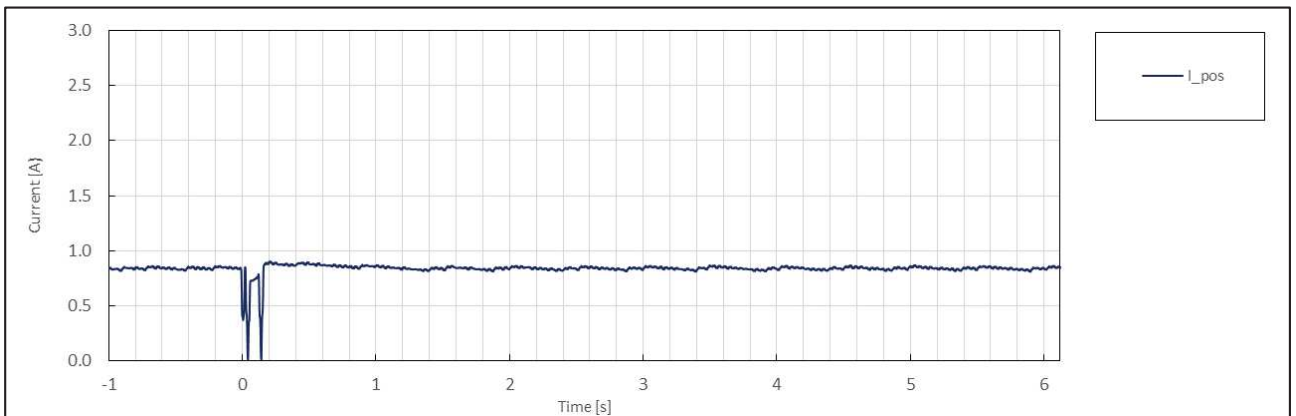
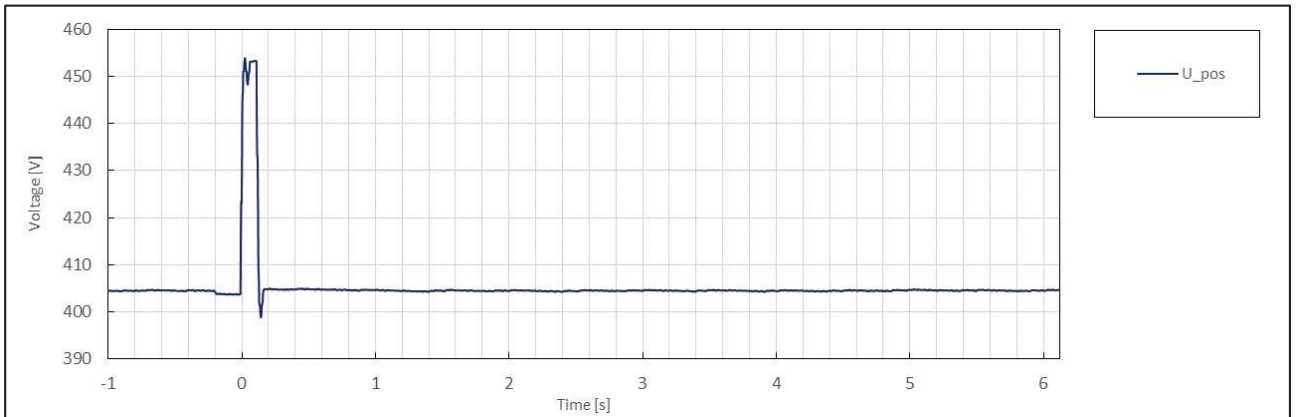
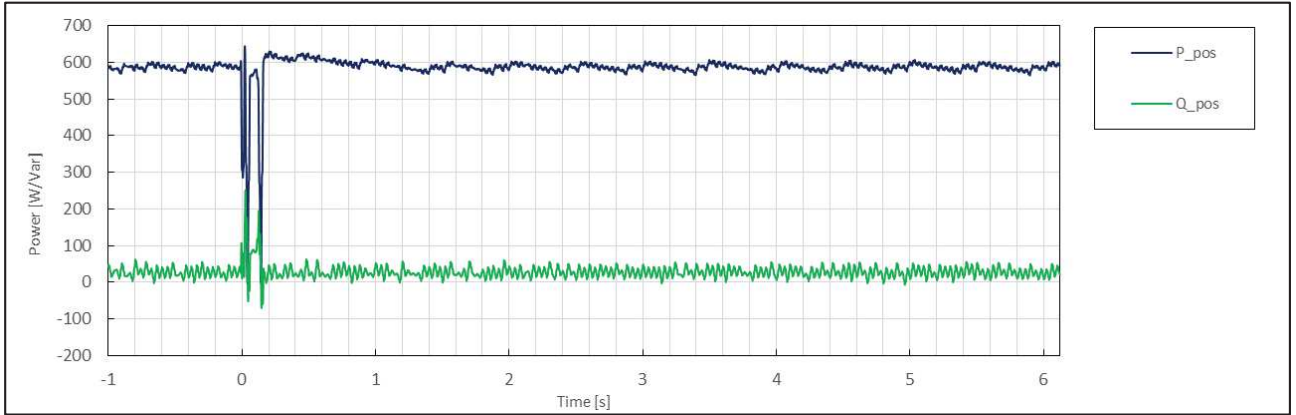

|                     | No. | Parameter  | Phase ref.      | Time ref.                       | unit       | Result        |
|---------------------|-----|--|-----------------|---------------------------------|------------|---------------|
| General Info.       | 0   | Test number  | --              | --                              | --         | 5.3(2)        |
|                     | 1   | Date   | --              | --                              | dd.mm.yyyy | 3.1.2020      |
|                     | 2   | Time (start of test)                                   | --              | --                              | hh:mm:ss.f | 14:43:27      |
|                     | 3   | Fault type (phase)                                     | --              | --                              |            | 2-phase fault |
|                     | 4   | Setting voltage depth                                  | Line to line    | --                              | p.u.       | 1.25          |
|                     | 5   | Setting dip duration                                   |                 | --                              |            | 121           |
|                     | 6   | Point of fault entry                                   | Total           | --                              | ms         | 0             |
|                     | 7   | Point of fault clearance                               | Total           | --                              | ms         | 120           |
|                     | 8   | Fault duration in empty load test                      | Total           | --                              | ms         | 121           |
|                     | 9   | Voltage depth/height in empty load test                | Total           | t1+100ms to t2 and t1-10s to t1 | p.u.       | 1.25          |
|                     | 10  |  | Pos.            |                                 | p.u.       | 1.12          |
| Before dip <t1      | 11  | Voltage  | Line to neutral | t1-100s to t1                   | p.u.       | 1.02          |
|                     | 12  | Current  | Pos.            | t1-500ms to t1-100ms            | p.u.       | 0.32          |
|                     | 13  | Active power   | Total           | t1-10s to t1                    | p.u.       | 1.00          |
|                     | 14  |  | Pos.            |                                 |            | 0.97          |
|                     | 15  | Reactive power   | Total           | t1-10s to t1                    | p.u.       | 0.05          |
|                     | 16  |  | Pos.            |                                 |            | 0.05          |
|                     | 17  | Cos $\varphi$  | --              | t1-10s to t1                    | --         | 0.999         |
| During dip t1 to t2 | 18  | Voltage  | Line to neutral | t1+100ms to t2-20ms             | p.u.       | 1.25          |
|                     | 19  | Line current   | Phase 1         | t1+60ms                         | p.u.       | N/A           |
|                     | 20  |  | Phase 2         |                                 |            | 0.03          |
|                     | 21  |  | Phase 3         |                                 |            | N/A           |
|                     | 22  | Line current   | Phase 1         | t1+100ms                        | p.u.       | N/A           |
|                     | 23  |  | Phase 2         |                                 |            | 0.03          |
|                     | 24  |  | Phase 3         |                                 |            | N/A           |
|                     | 25  | Active power   | Total           | t1+100ms to t2-20ms             | p.u.       | 0.01          |
|                     | 26  |  | Pos.            |                                 |            | -0.01         |
| After dip > t2      | 27  | Voltage  | Line to neutral | t2+3s to t2+10s                 | p.u.       | 1.02          |
|                     | 28  | Active power   | Total           | t2+3s to t2+10s                 | p.u.       | 1.00          |
|                     | 29  |  | Pos.            |                                 |            | 0.97          |
|                     | 39  | Active power rising time                               | Pos.            | --                              | s          | 0.840         |
|                     | 31  | Reactive power   | Total           | t2+3s to t2+10s                 | p.u.       | 0.05          |
|                     | 32  |  | Pos.            |                                 |            | 0.05          |
|                     | 33  | Reactive power rising time                             | Pos.            | --                              | s          | N/A           |
|                     | 34  | PGU does not disconnect from grid till 60s after fault | --              | t2 to t2+60s                    | Yes / No   | No            |

Test No. 5.3(D2) idle test

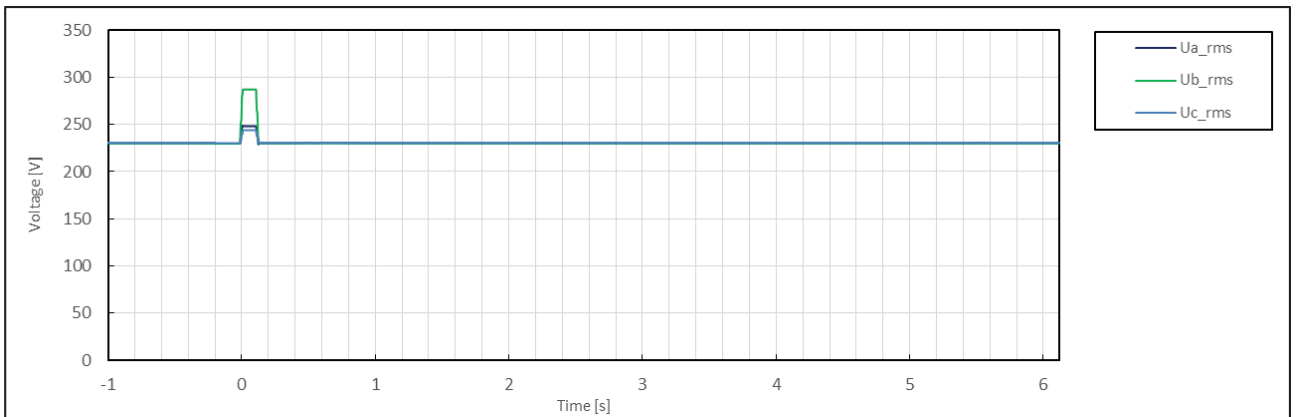
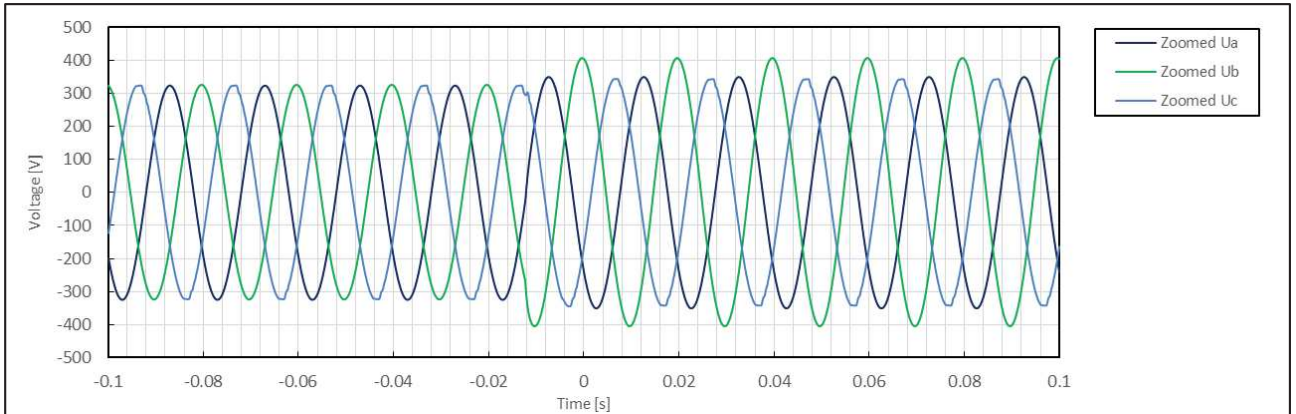
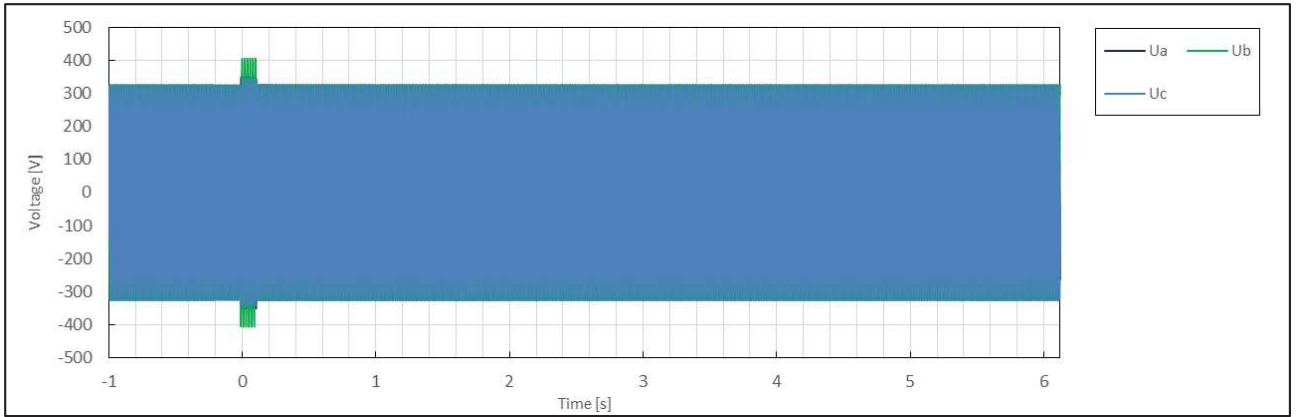

Test No. 5.3(D2) with PGU

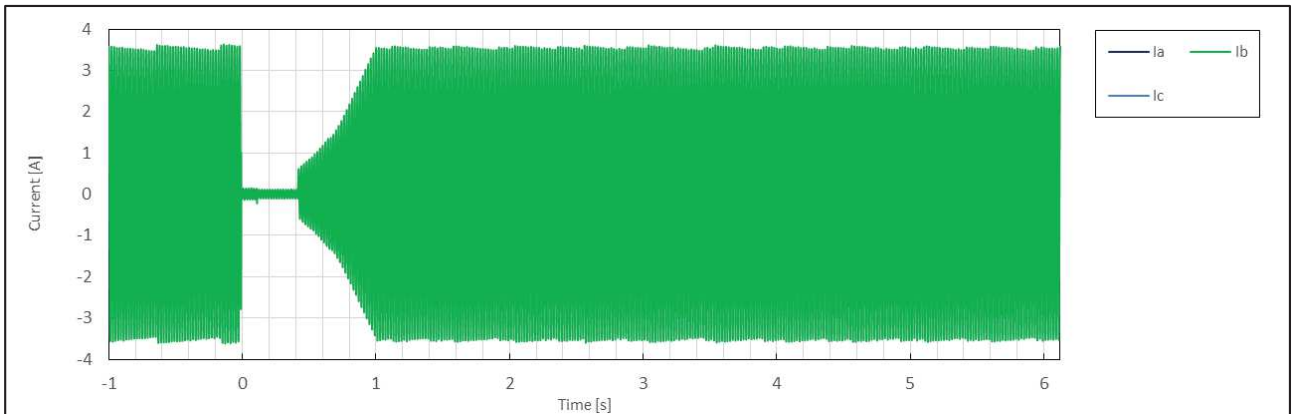
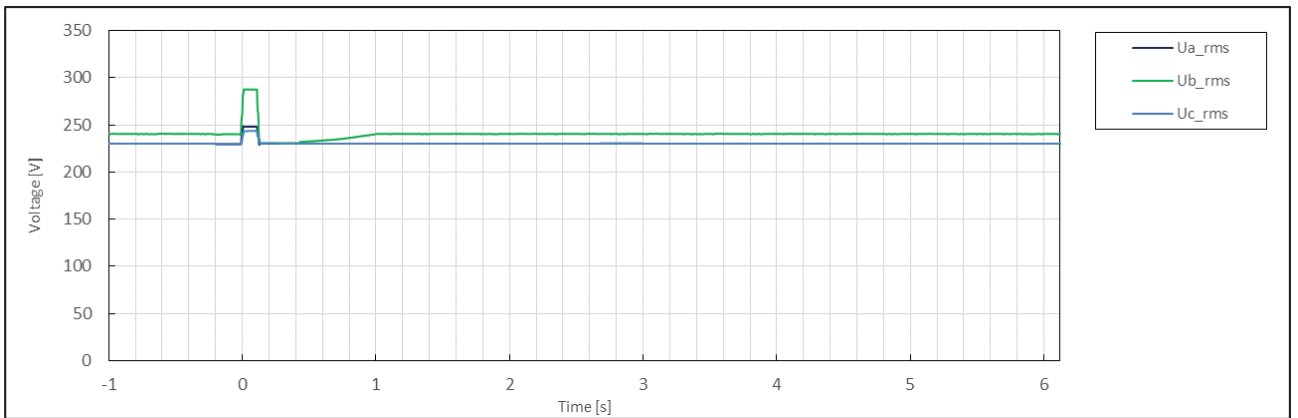
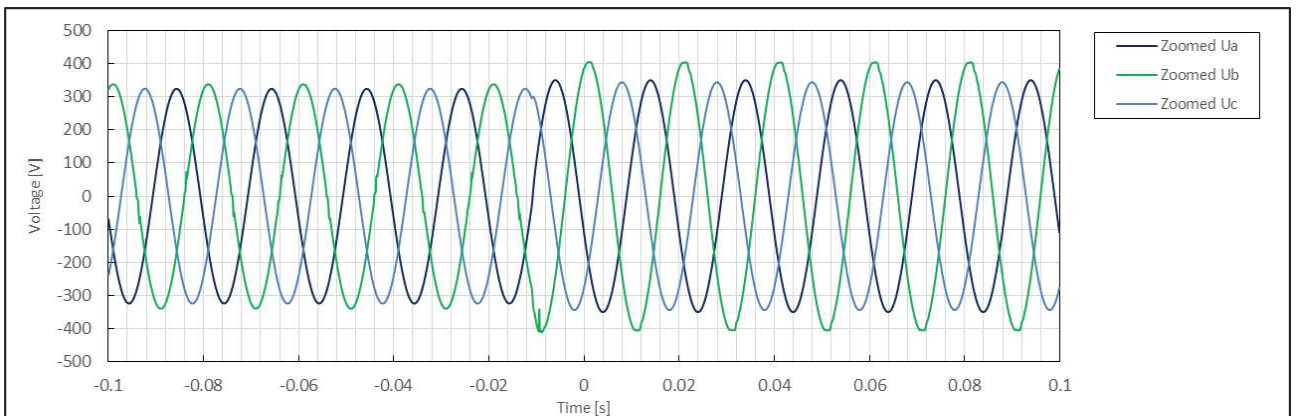
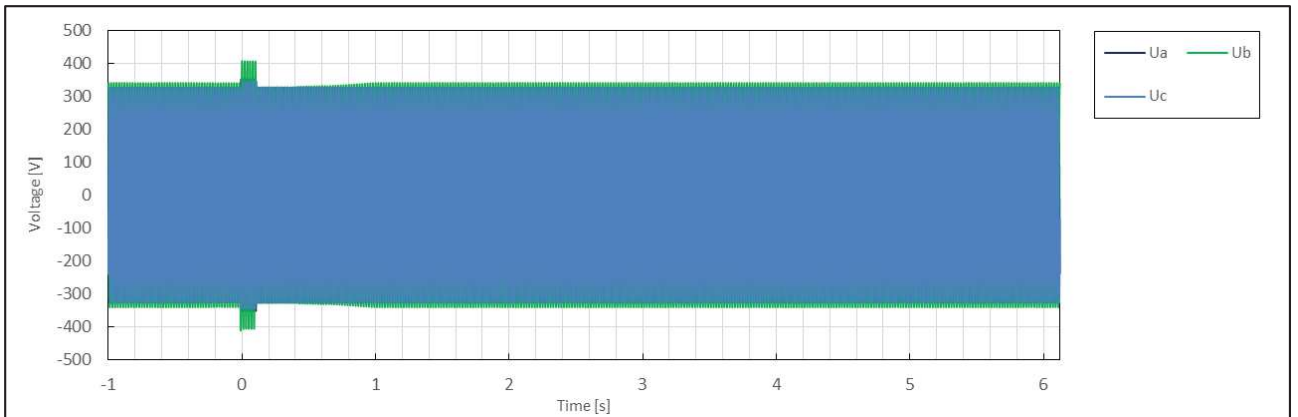

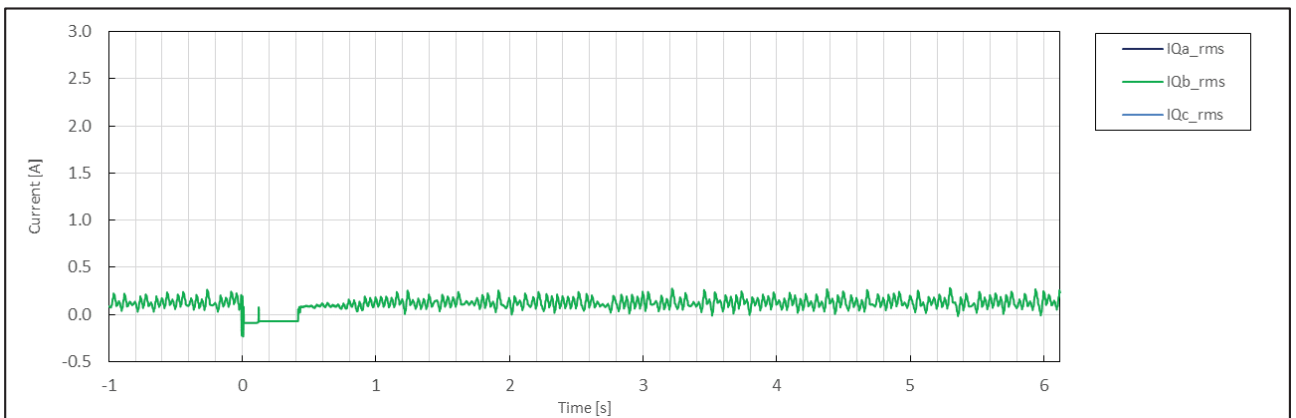
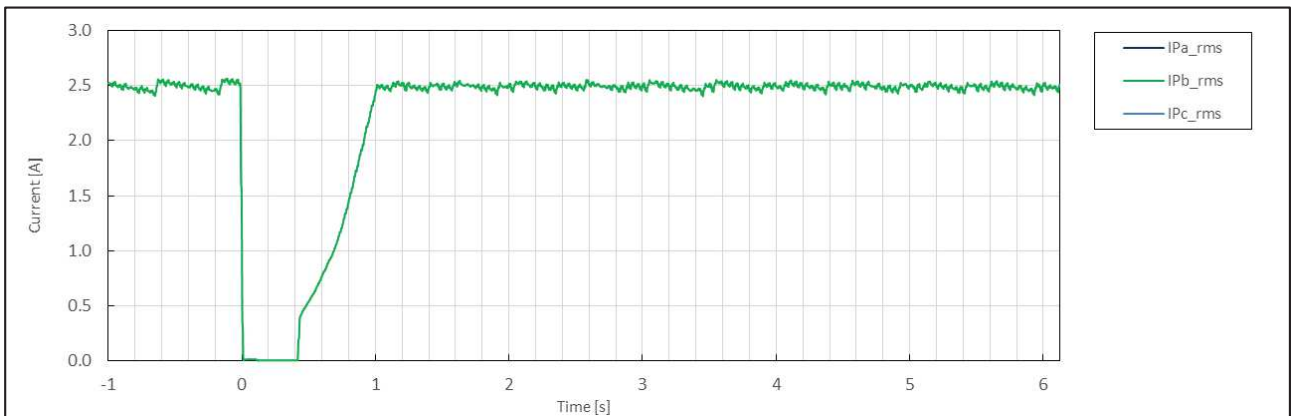
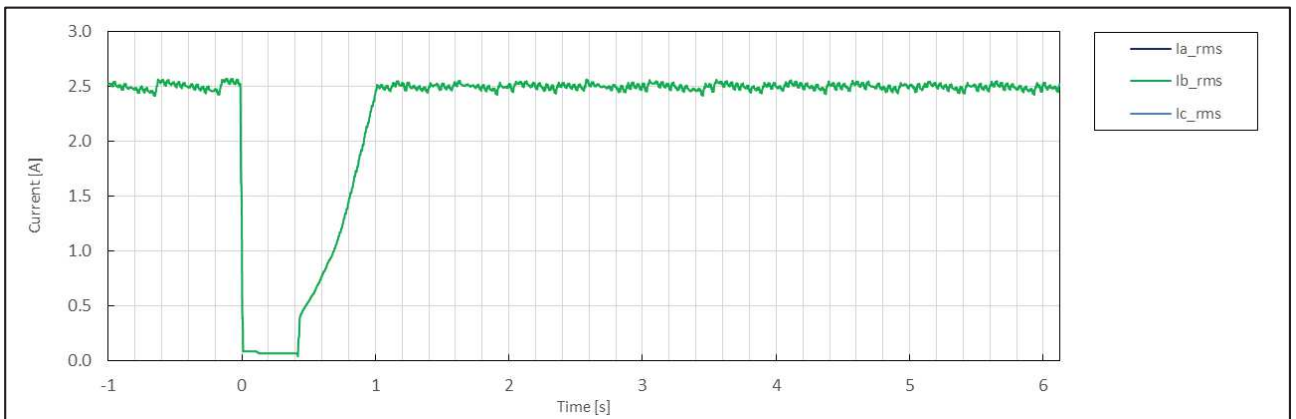
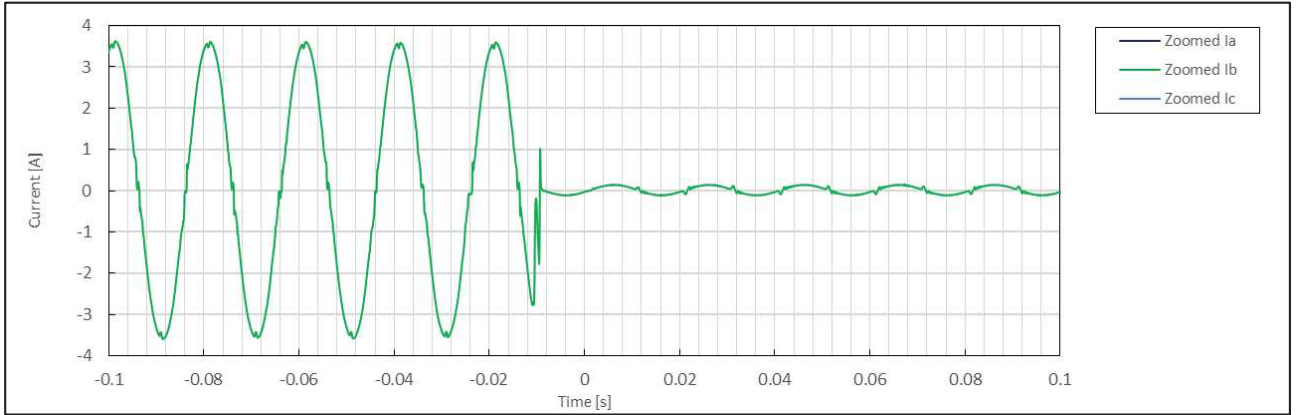

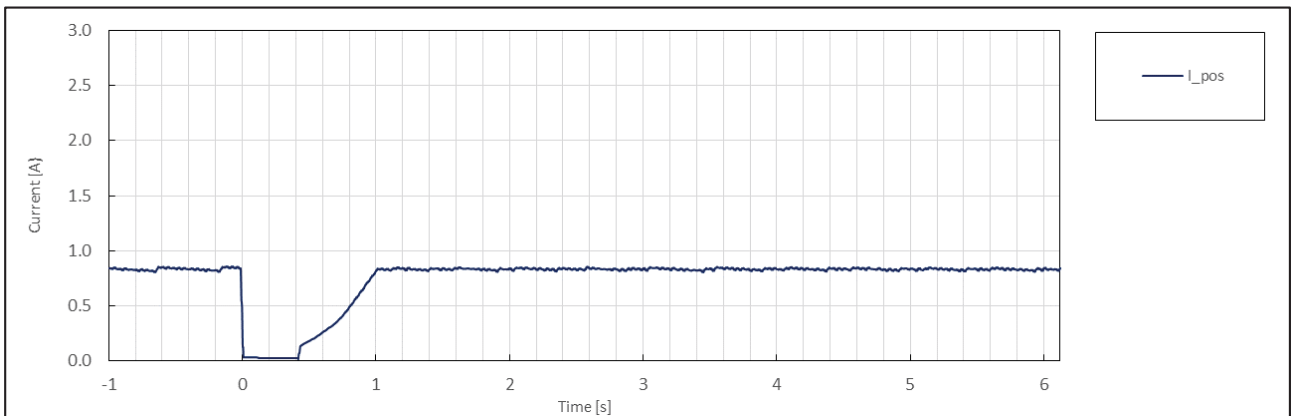
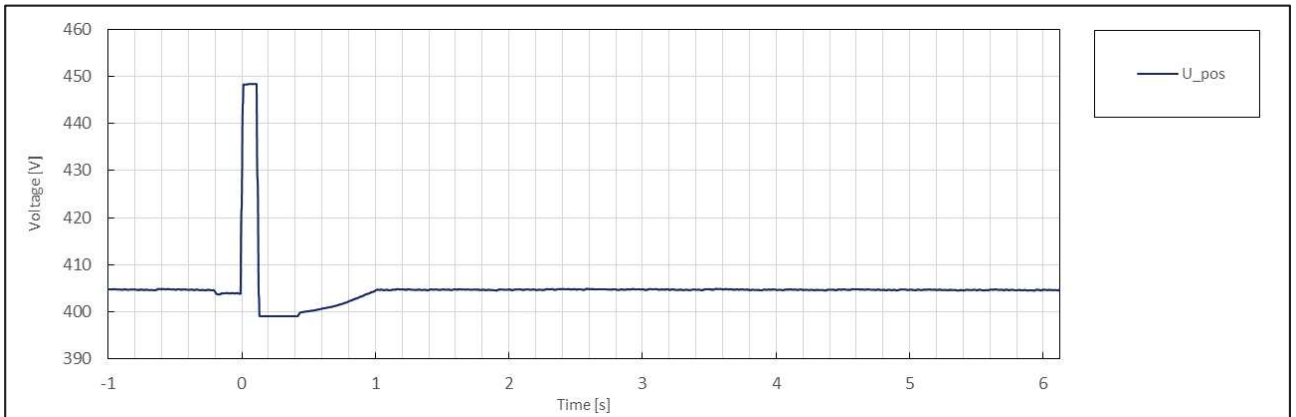
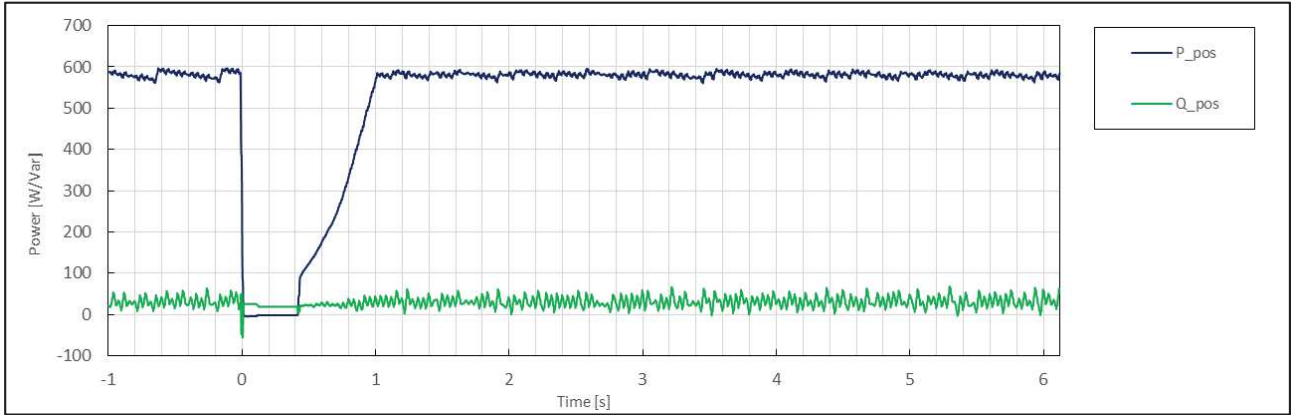

|                     | No. | Parameter  | Phase ref.      | Time ref.                       | unit       | Result        |
|---------------------|-----|--|-----------------|---------------------------------|------------|---------------|
| General Info.       | 0   | Test number  | --              | --                              | --         | 5.4           |
|                     | 1   | Date   | --              | --                              | dd.mm.yyyy | 3.1.2020      |
|                     | 2   | Time (start of test)                                   | --              | --                              | hh:mm:ss.f | 14:50:14      |
|                     | 3   | Fault type (phase)                                     | --              | --                              |            | 2-phase fault |
|                     | 4   | Setting voltage depth                                  | Line to line    | --                              | p.u.       | 1.25          |
|                     | 5   | Setting dip duration                                   |                 | --                              |            | 121           |
|                     | 6   | Point of fault entry                                   | Total           | --                              | ms         | 0             |
|                     | 7   | Point of fault clearance                               | Total           | --                              | ms         | 120           |
|                     | 8   | Fault duration in empty load test                      | Total           | --                              | ms         | 121           |
|                     | 9   | Voltage depth/height in empty load test                | Total           | t1+100ms to t2 and t1-10s to t1 | p.u.       | 1.06          |
|                     | 10  |  | Pos.            |                                 | p.u.       | 1.12          |
| Before dip <t1      | 11  | Voltage  | Line to neutral | t1-100s to t1                   | p.u.       | 1.01          |
|                     | 12  | Current  | Pos.            | t1-500ms to t1-100ms            | p.u.       | 0.11          |
|                     | 13  | Active power   | Total           | t1-10s to t1                    | p.u.       | 0.33          |
|                     | 14  |  | Pos.            |                                 |            | 0.33          |
|                     | 15  | Reactive power   | Total           | t1-10s to t1                    | p.u.       | 0.04          |
|                     | 16  |  | Pos.            |                                 |            | 0.04          |
|                     | 17  | Cos $\varphi$  | --              | t1-10s to t1                    | --         | 0.994         |
| During dip t1 to t2 | 18  | Voltage  | Line to neutral | t1+100ms to t2-20ms             | p.u.       | 1.07          |
|                     | 19  | Line current   | Phase 1         | t1+60ms                         | p.u.       | N/A           |
|                     | 20  |  | Phase 2         |                                 |            | N/A           |
|                     | 21  |  | Phase 3         |                                 |            | 0.30          |
|                     | 22  | Line current   | Phase 1         | t1+100ms                        | p.u.       | N/A           |
|                     | 23  |  | Phase 2         |                                 |            | N/A           |
|                     | 24  |  | Phase 3         |                                 |            | 0.31          |
|                     | 25  | Active power   | Total           | t1+100ms to t2-20ms             | p.u.       | 0.33          |
|                     | 26  |  | Pos.            |                                 |            | 0.34          |
| After dip > t2      | 27  | Voltage  | Line to neutral | t2+3s to t2+10s                 | p.u.       | 1.01          |
|                     | 28  | Active power   | Total           | t2+3s to t2+10s                 | p.u.       | 0.33          |
|                     | 29  |  | Pos.            |                                 |            | 0.33          |
|                     | 39  | Active power rising time                               | Pos.            | --                              | s          | N/A           |
|                     | 31  | Reactive power   | Total           | t2+3s to t2+10s                 | p.u.       | 0.04          |
|                     | 32  |  | Pos.            |                                 |            | 0.04          |
|                     | 33  | Reactive power rising time                             | Pos.            | --                              | s          | N/A           |
|                     | 34  | PGU does not disconnect from grid till 60s after fault | --              | t2 to t2+60s                    | Yes / No   | No            |

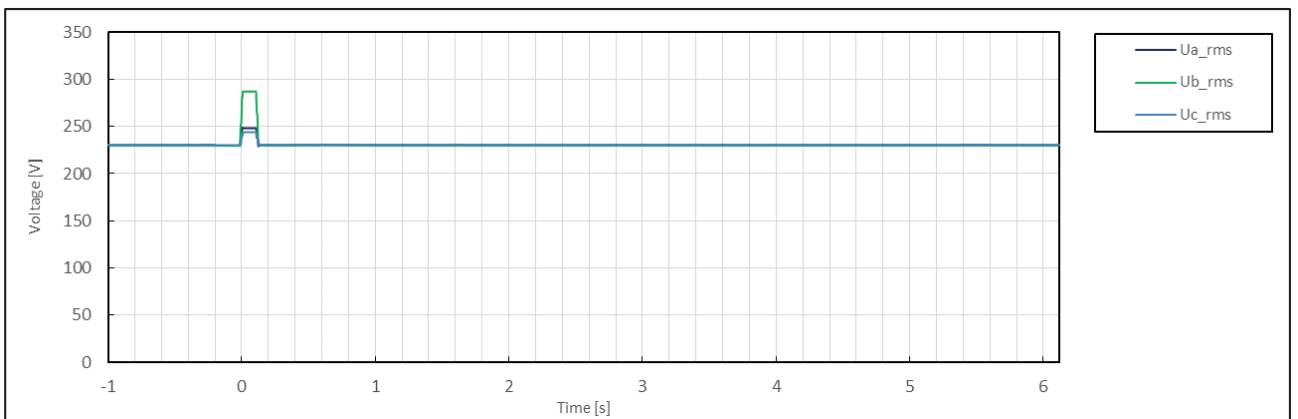
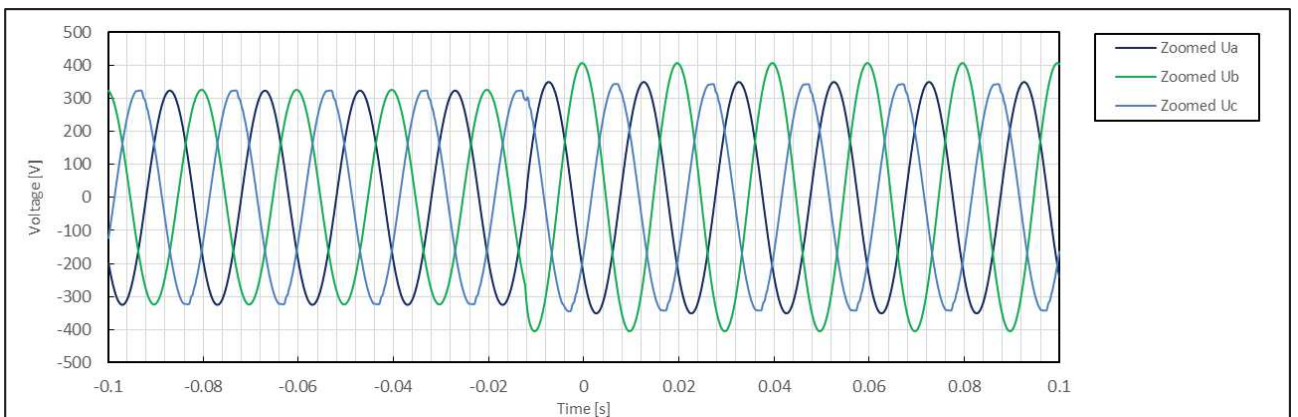
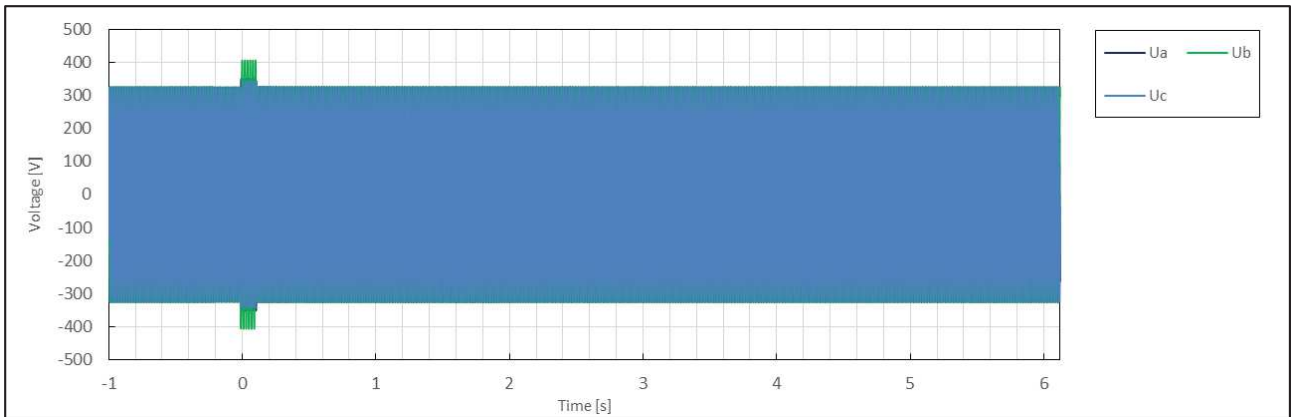



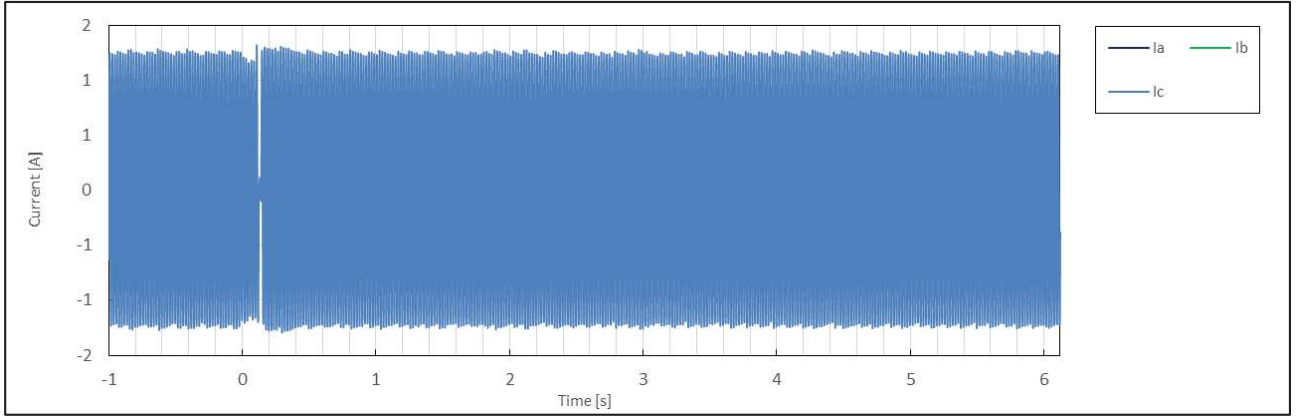
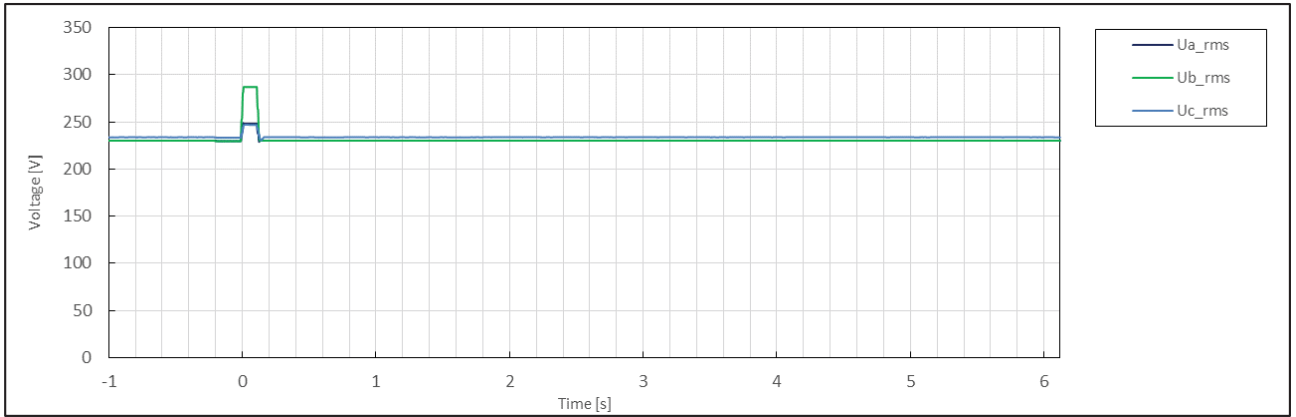
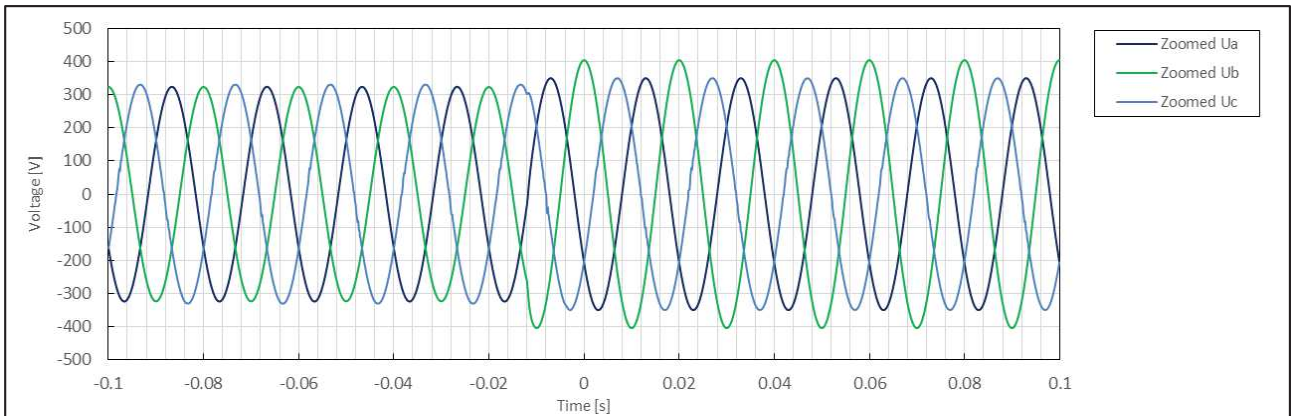
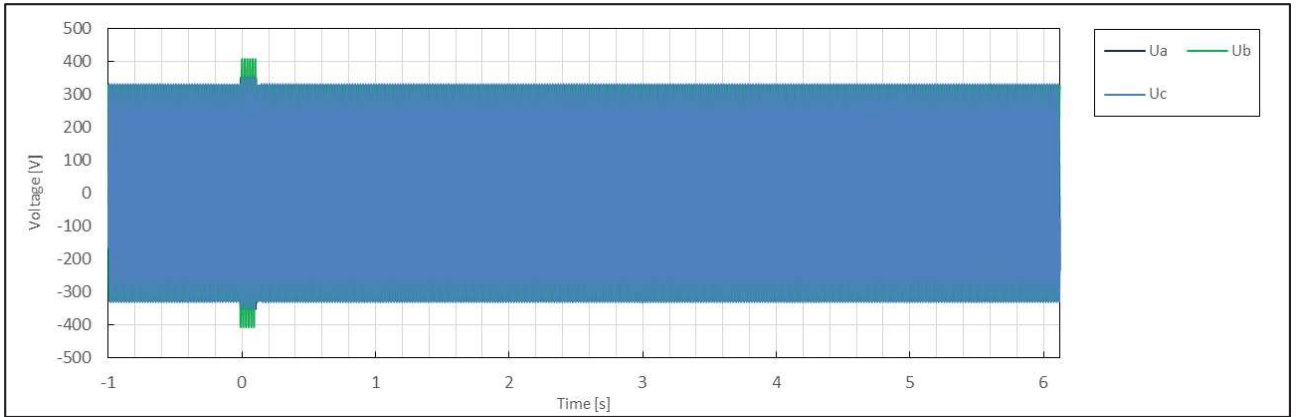

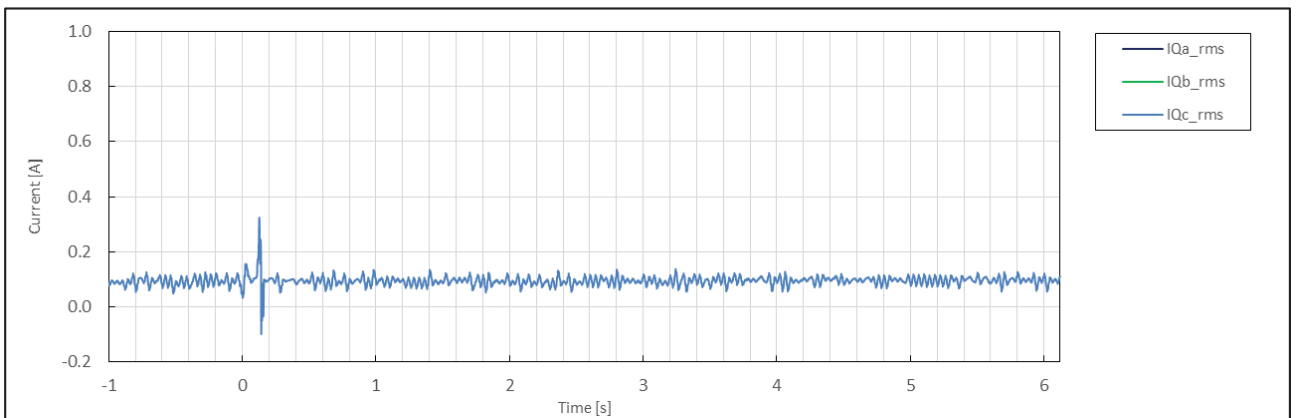
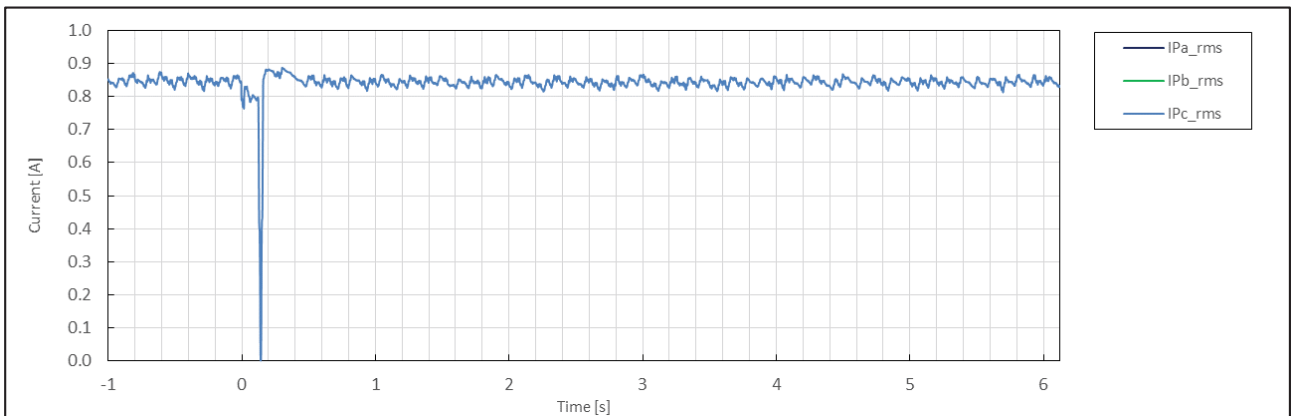
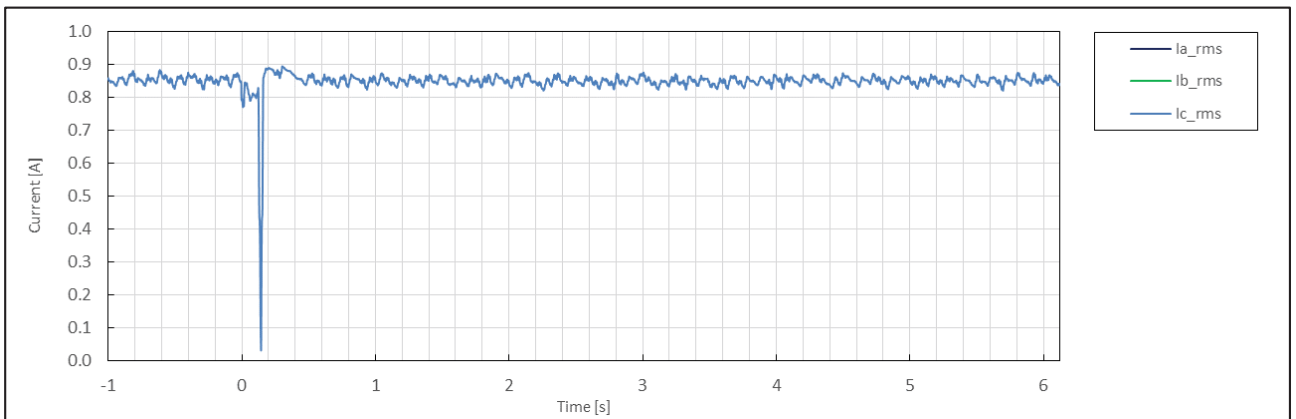
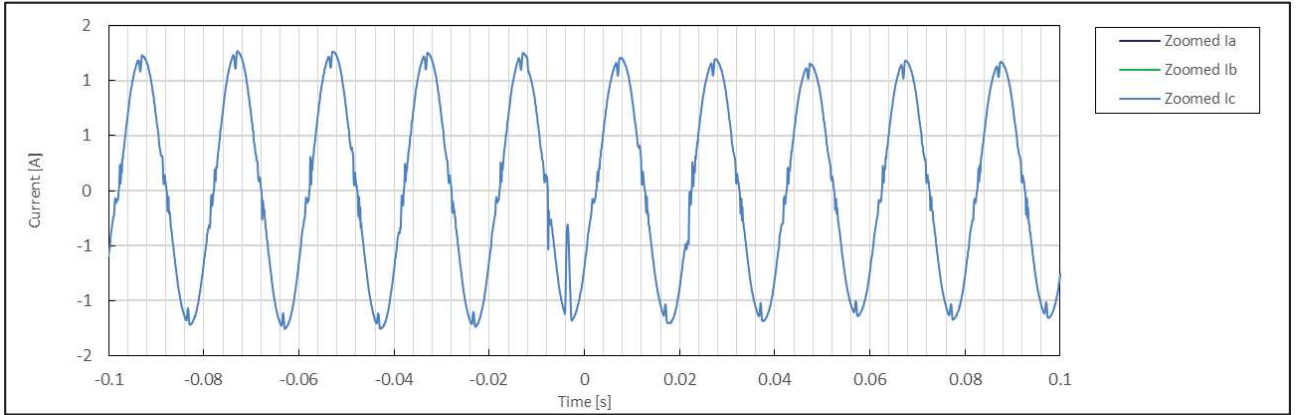

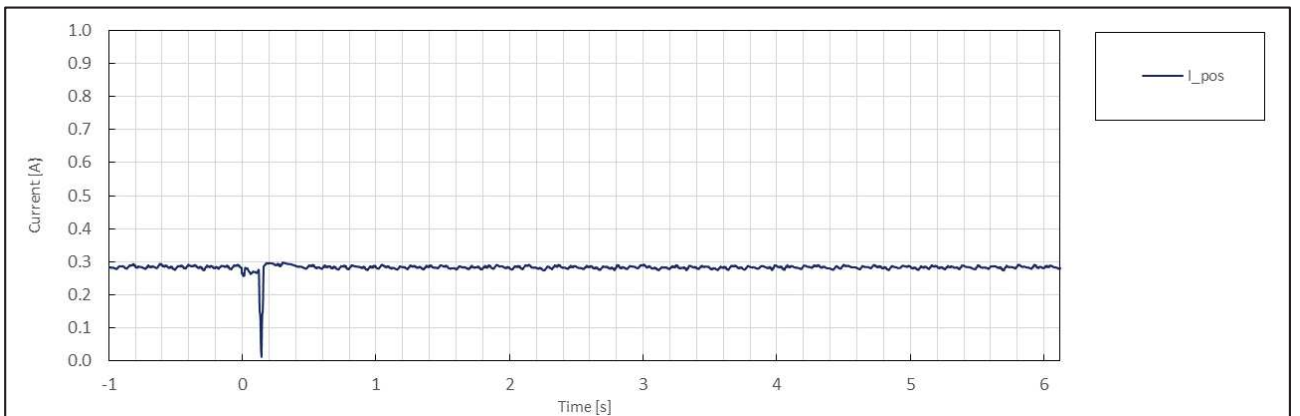
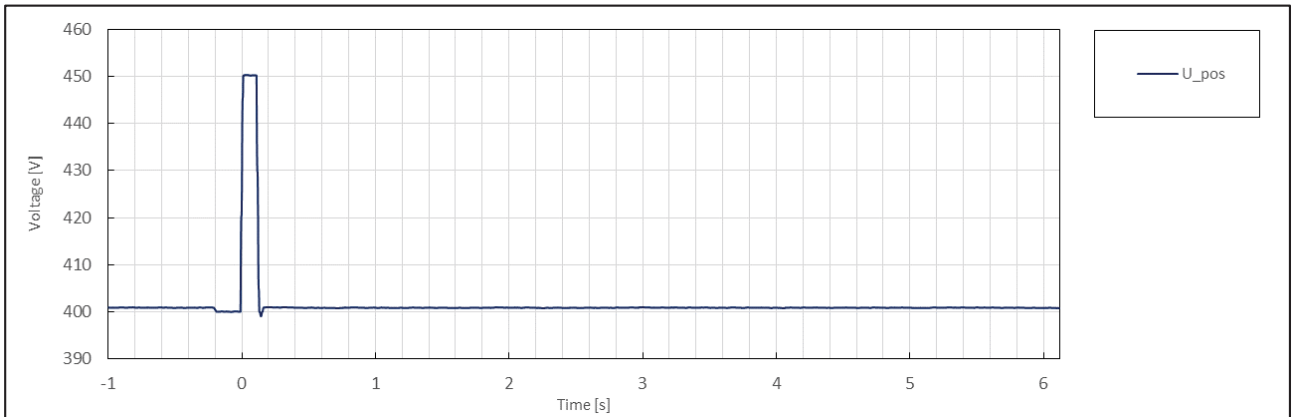
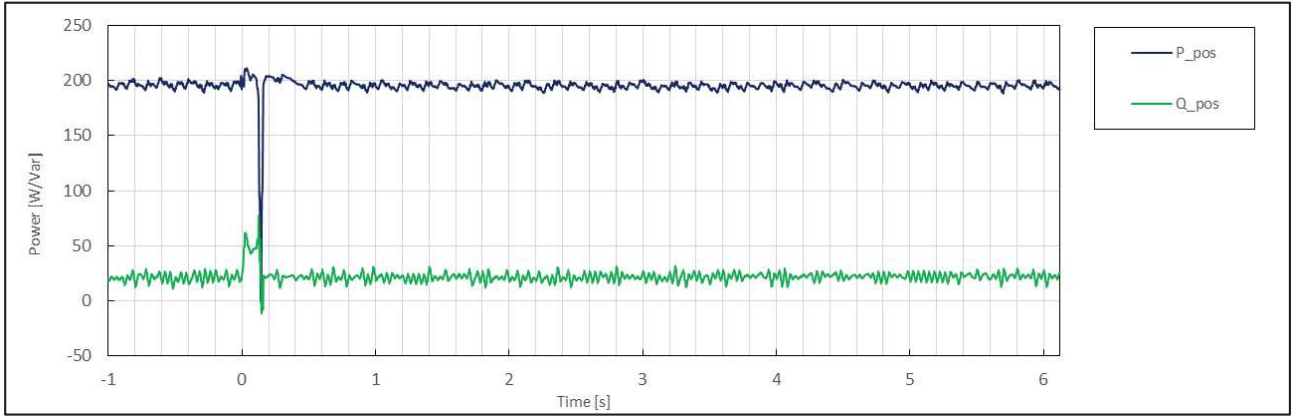

|                     | No. | Parameter  | Phase ref.      | Time ref.                       | unit       | Result        |
|---------------------|-----|--|-----------------|---------------------------------|------------|---------------|
| General Info.       | 0   | Test number  | --              | --                              | --         | 5.4(2)        |
|                     | 1   | Date   | --              | --                              | dd.mm.yyyy | 3.1.2020      |
|                     | 2   | Time (start of test)                                   | --              | --                              | hh:mm:ss.f | 14:55:29      |
|                     | 3   | Fault type (phase)                                     | --              | --                              |            | 2-phase fault |
|                     | 4   | Setting voltage depth                                  | Line to line    | --                              | p.u.       | 1.25          |
|                     | 5   | Setting dip duration                                   |                 | --                              |            | 121           |
|                     | 6   | Point of fault entry                                   | Total           | --                              | ms         | 0             |
|                     | 7   | Point of fault clearance                               | Total           | --                              | ms         | 120           |
|                     | 8   | Fault duration in empty load test                      | Total           | --                              | ms         | 121           |
|                     | 9   | Voltage depth/height in empty load test                | Total           | t1+100ms to t2 and t1-10s to t1 | p.u.       | 1.25          |
|                     | 10  |  | Pos.            |                                 | p.u.       | 1.12          |
| Before dip <t1      | 11  | Voltage  | Line to neutral | t1-100s to t1                   | p.u.       | 1.01          |
|                     | 12  | Current  | Pos.            | t1-500ms to t1-100ms            | p.u.       | 0.16          |
|                     | 13  | Active power   | Total           | t1-10s to t1                    | p.u.       | 0.49          |
|                     | 14  |  | Pos.            |                                 |            | 0.48          |
|                     | 15  | Reactive power   | Total           | t1-10s to t1                    | p.u.       | 0.04          |
|                     | 16  |  | Pos.            |                                 |            | 0.04          |
|                     | 17  | Cos $\phi$   | --              | t1-10s to t1                    | --         | 0.997         |
| During dip t1 to t2 | 18  | Voltage  | Line to neutral | t1+100ms to t2-20ms             | p.u.       | 1.25          |
|                     | 19  | Line current   | Phase 1         | t1+60ms                         | p.u.       | N/A           |
|                     | 20  |  | Phase 2         |                                 |            | 0.03          |
|                     | 21  |  | Phase 3         |                                 |            | N/A           |
|                     | 22  | Line current   | Phase 1         | t1+100ms                        | p.u.       | N/A           |
|                     | 23  |  | Phase 2         |                                 |            | 0.03          |
|                     | 24  |  | Phase 3         |                                 |            | N/A           |
|                     | 25  | Active power   | Total           | t1+100ms to t2-20ms             | p.u.       | 0.01          |
|                     | 26  |  | Pos.            |                                 |            | -0.01         |
| After dip > t2      | 27  | Voltage  | Line to neutral | t2+3s to t2+10s                 | p.u.       | 1.01          |
|                     | 28  | Active power   | Total           | t2+3s to t2+10s                 | p.u.       | 0.49          |
|                     | 29  |  | Pos.            |                                 |            | 0.48          |
|                     | 39  | Active power rising time                               | Pos.            | --                              | s          | 0.598         |
|                     | 31  | Reactive power   | Total           | t2+3s to t2+10s                 | p.u.       | 0.04          |
|                     | 32  |  | Pos.            |                                 |            | 0.04          |
|                     | 33  | Reactive power rising time                             | Pos.            | --                              | s          | N/A           |
|                     | 34  | PGU does not disconnect from grid till 60s after fault | --              | t2 to t2+60s                    | Yes / No   | No            |

Test No. 5.4(D2) idle test

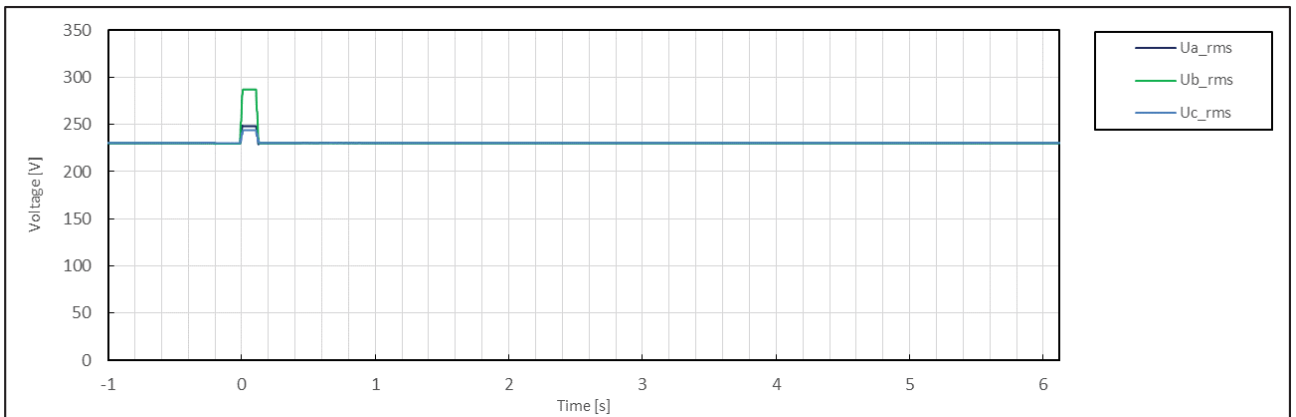
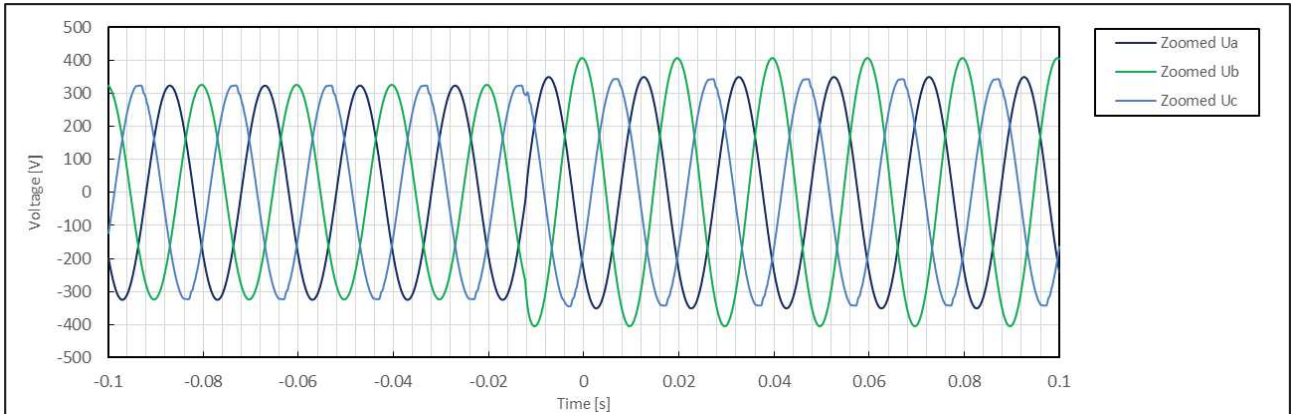
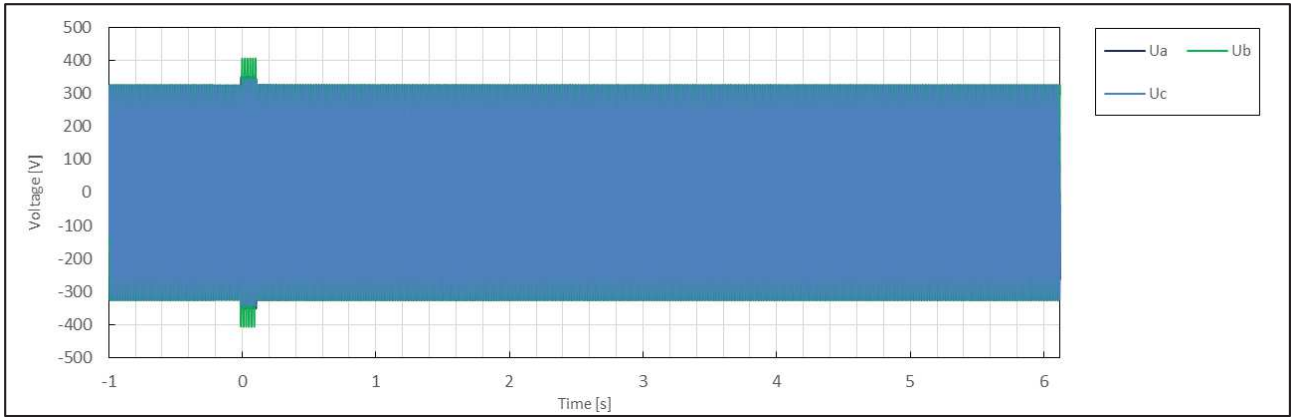

Test No. 5.4(D2) with PGU

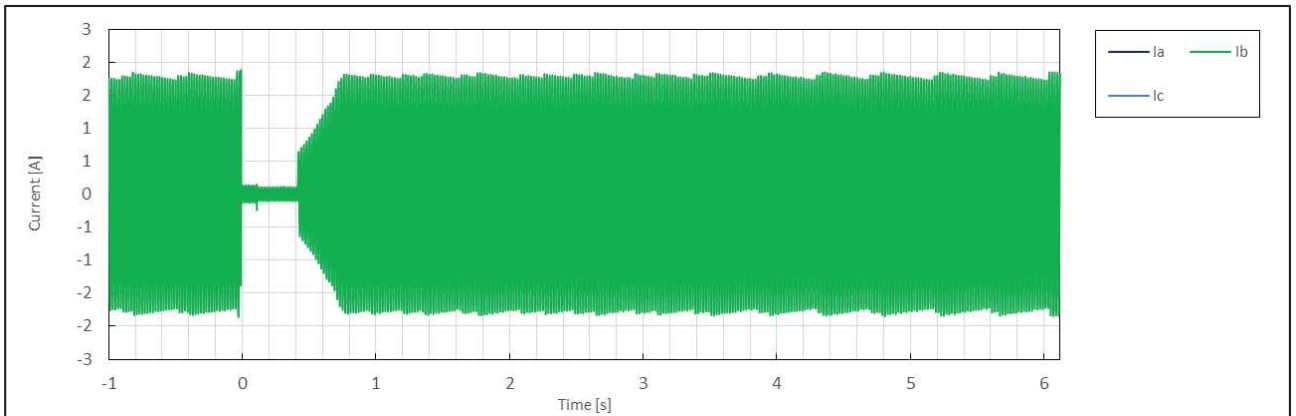
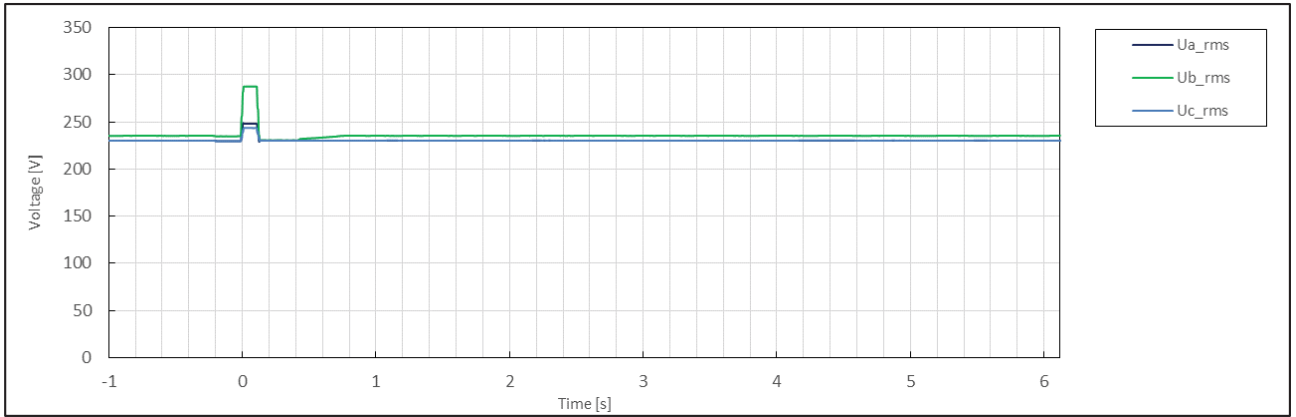
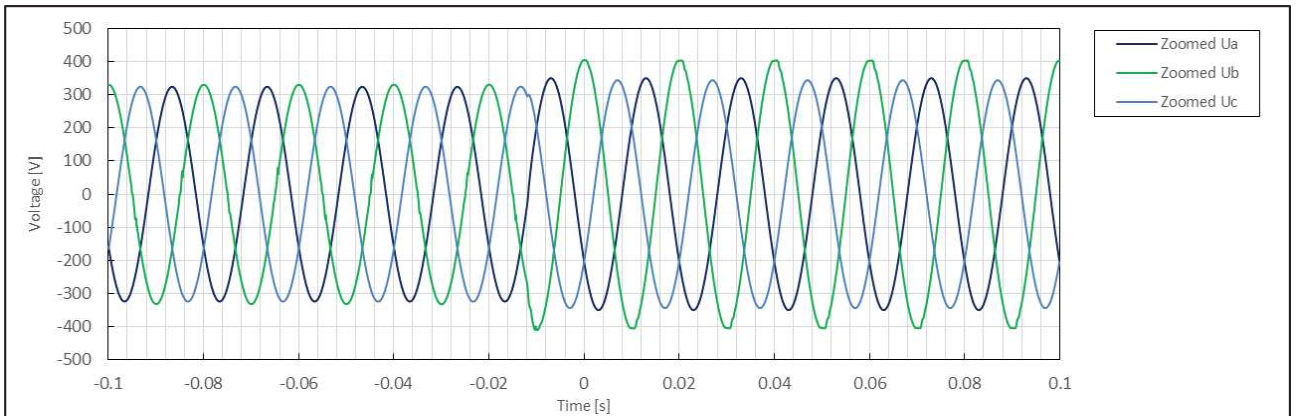
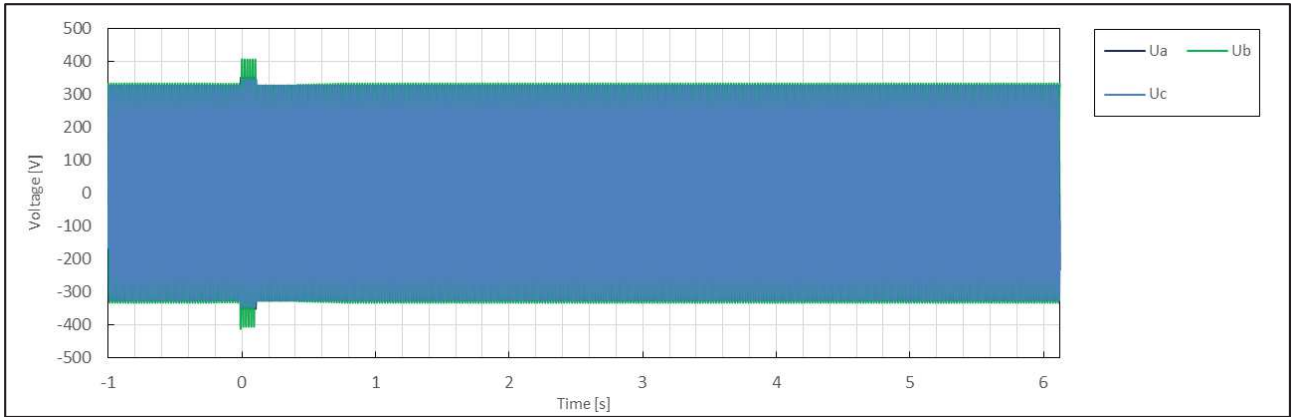

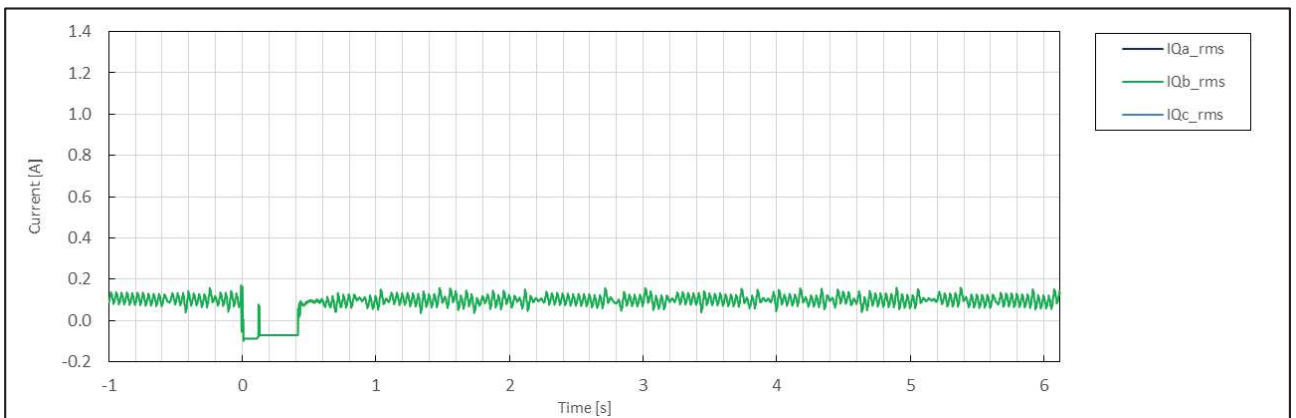
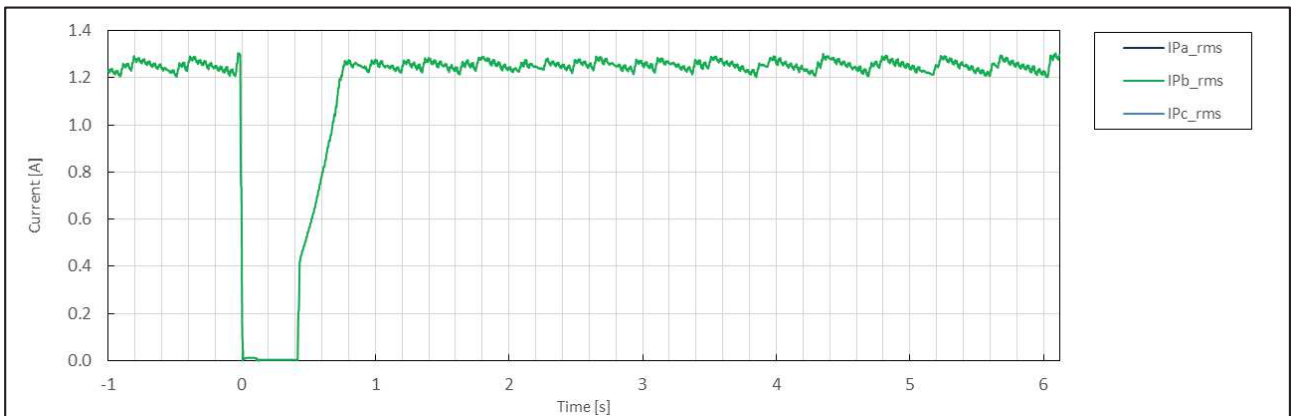
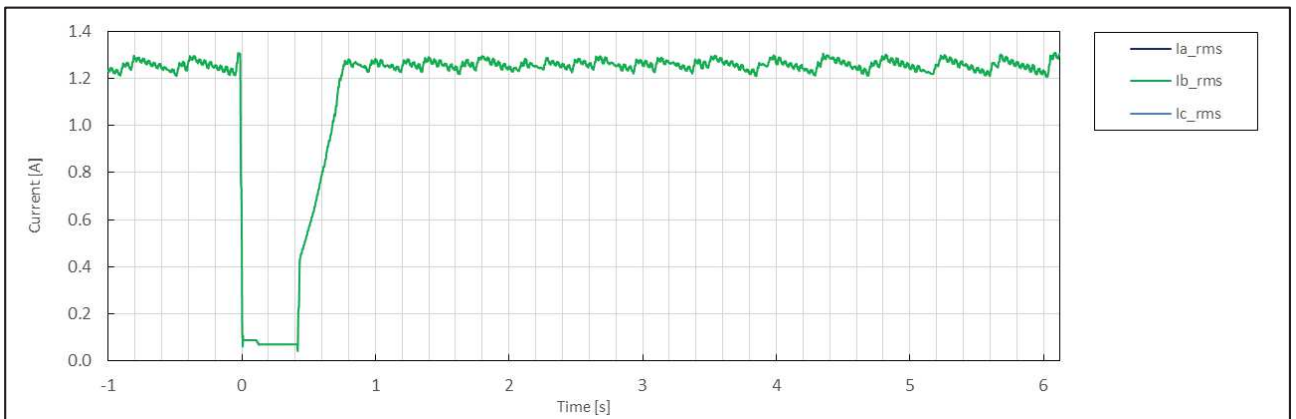
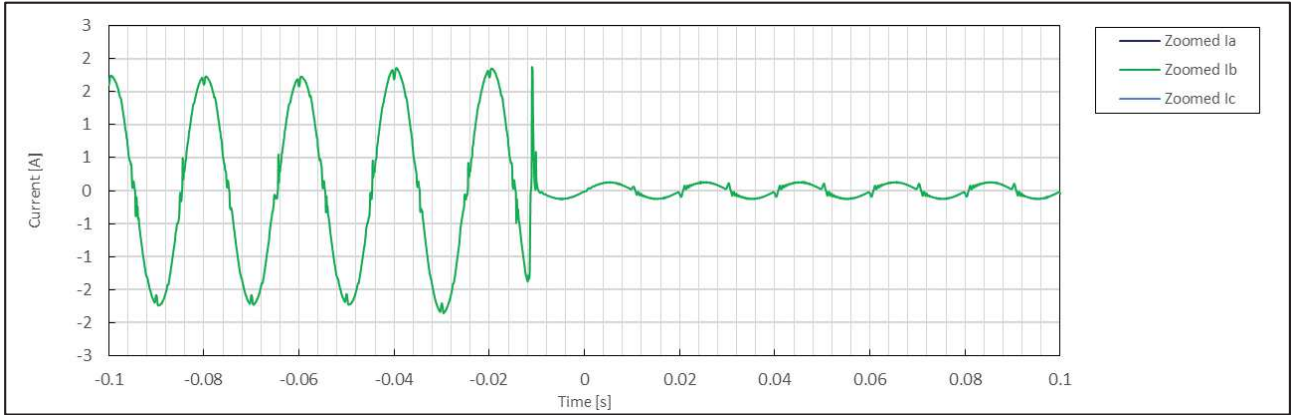



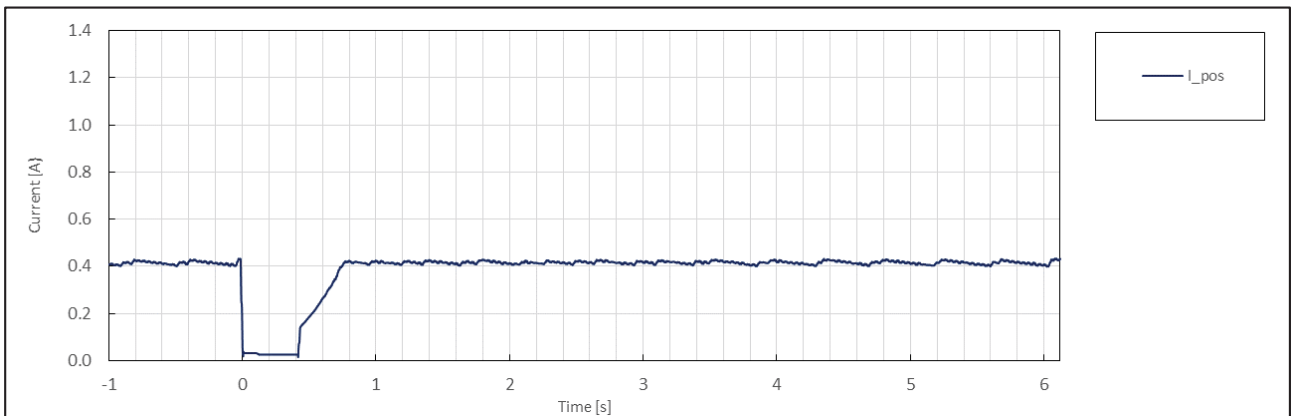
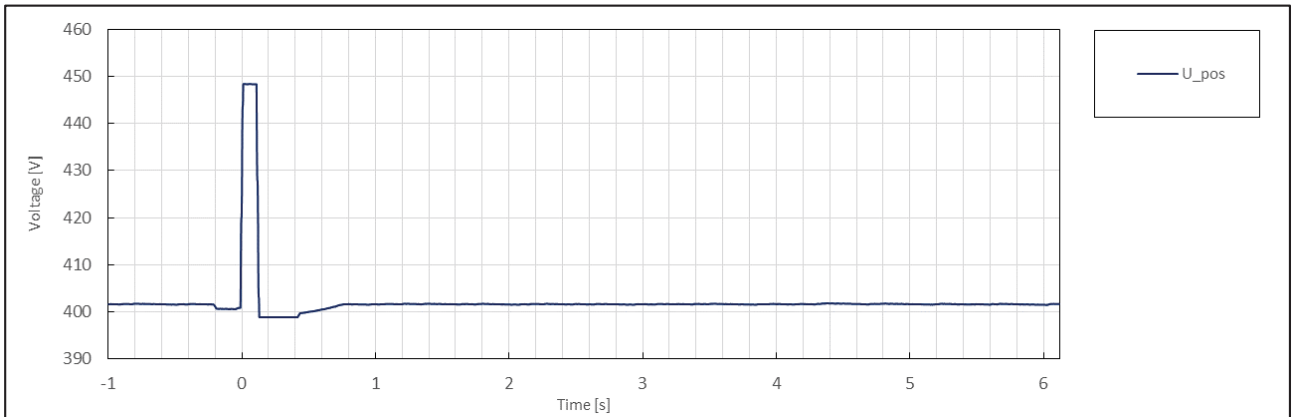
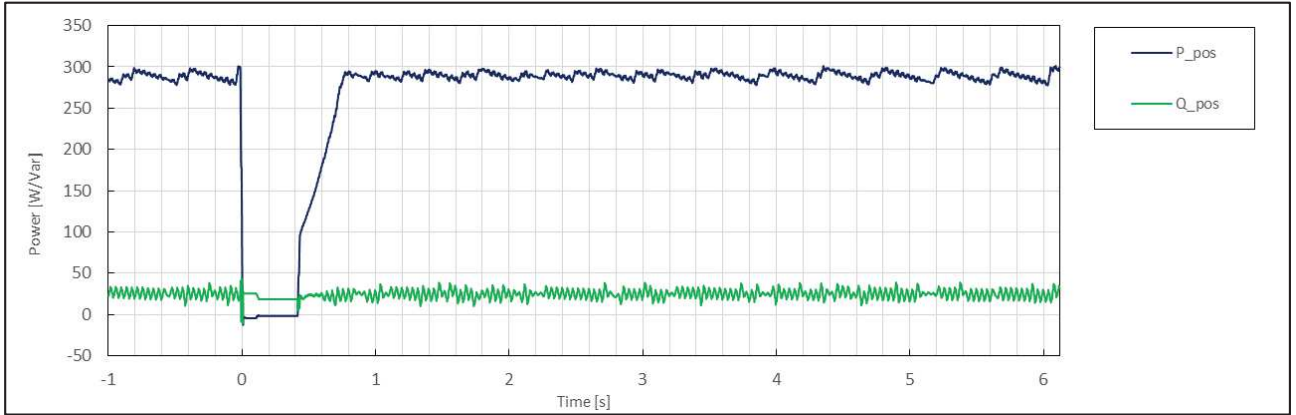



|                     | No. | Parameter  | Phase ref.      | Time ref.                       | unit       | Result        |
|---------------------|-----|--|-----------------|---------------------------------|------------|---------------|
| General Info.       | 0   | Test number  | --              | --                              | --         | 6.1           |
|                     | 1   | Date   | --              | --                              | dd.mm.yyyy | 3.1.2020      |
|                     | 2   | Time (start of test)                                   | --              | --                              | hh:mm:ss.f | 15:02:09      |
|                     | 3   | Fault type (phase)                                     | --              | --                              |            | 3-phase fault |
|                     | 4   | Setting voltage depth                                  | Line to line    | --                              | p.u.       | 1.20          |
|                     | 5   | Setting dip duration                                   |                 | --                              |            | 5018          |
|                     | 6   | Point of fault entry                                   | Total           | --                              | ms         | 0             |
|                     | 7   | Point of fault clearance                               | Total           | --                              | ms         | 5017          |
|                     | 8   | Fault duration in empty load test                      | Total           | --                              | ms         | 5018          |
|                     | 9   | Voltage depth/height in empty load test                | Total           | t1+100ms to t2 and t1-10s to t1 | p.u.       | 1.20          |
|                     | 10  |  | Pos.            |                                 | p.u.       | 1.20          |
| Before dip <t1      | 11  | Voltage  | Line to neutral | t1-100s to t1                   | p.u.       | 1.02          |
|                     | 12  | Current  | Pos.            | t1-500ms to t1-100ms            | p.u.       | 0.32          |
|                     | 13  | Active power   | Total           | t1-10s to t1                    | p.u.       | 1.01          |
|                     | 14  |  | Pos.            |                                 |            | 0.98          |
|                     | 15  | Reactive power   | Total           | t1-10s to t1                    | p.u.       | 0.05          |
|                     | 16  |  | Pos.            |                                 |            | 0.05          |
|                     | 17  | Cos $\varphi$  | --              | t1-10s to t1                    | --         | 0.999         |
| During dip t1 to t2 | 18  | Voltage  | Line to neutral | t1+100ms to t2-20ms             | p.u.       | 1.20          |
|                     | 19  | Line current   | Phase 1         | t1+60ms                         | p.u.       | N/A           |
|                     | 20  |  | Phase 2         |                                 |            | N/A           |
|                     | 21  |  | Phase 3         |                                 |            | 0.03          |
|                     | 22  | Line current   | Phase 1         | t1+100ms                        | p.u.       | N/A           |
|                     | 23  |  | Phase 2         |                                 |            | N/A           |
|                     | 24  |  | Phase 3         |                                 |            | 0.03          |
|                     | 25  | Active power   | Total           | t1+100ms to t2-20ms             | p.u.       | 0.00          |
|                     | 26  |  | Pos.            |                                 |            | 0.00          |
| After dip > t2      | 27  | Voltage  | Line to neutral | t2+3s to t2+10s                 | p.u.       | 1.02          |
|                     | 28  | Active power   | Total           | t2+3s to t2+10s                 | p.u.       | 1.01          |
|                     | 29  |  | Pos.            |                                 |            | 0.98          |
|                     | 39  | Active power rising time                               | Pos.            | --                              | s          | 0.720         |
|                     | 31  | Reactive power   | Total           | t2+3s to t2+10s                 | p.u.       | 0.05          |
|                     | 32  |  | Pos.            |                                 |            | 0.05          |
|                     | 33  | Reactive power rising time                             | Pos.            | --                              | s          | N/A           |
|                     | 34  | PGU does not disconnect from grid till 60s after fault | --              | t2 to t2+60s                    | Yes / No   | No            |

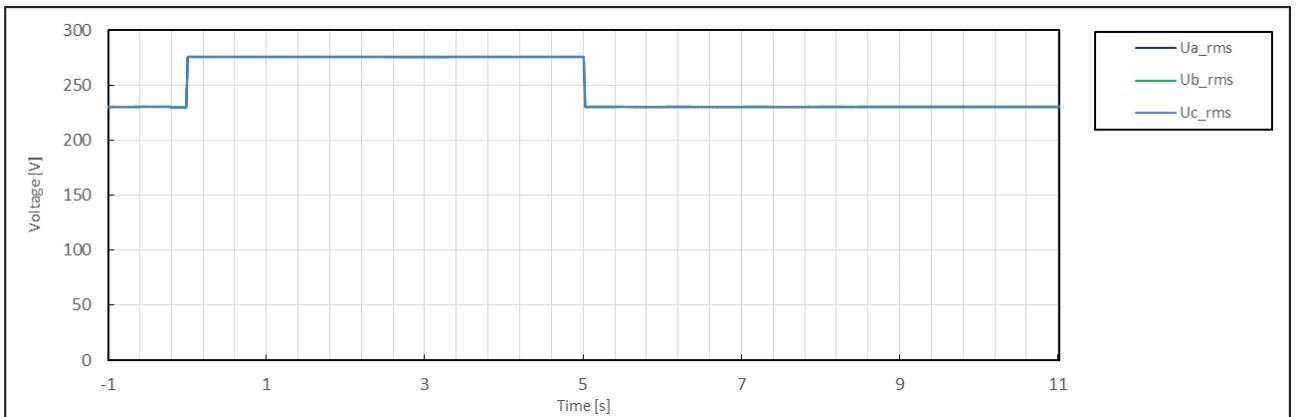
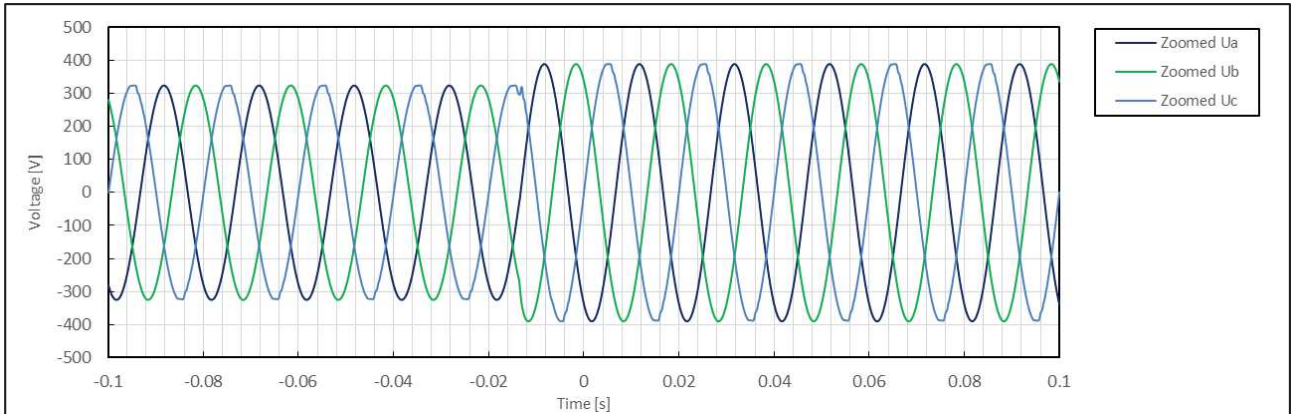
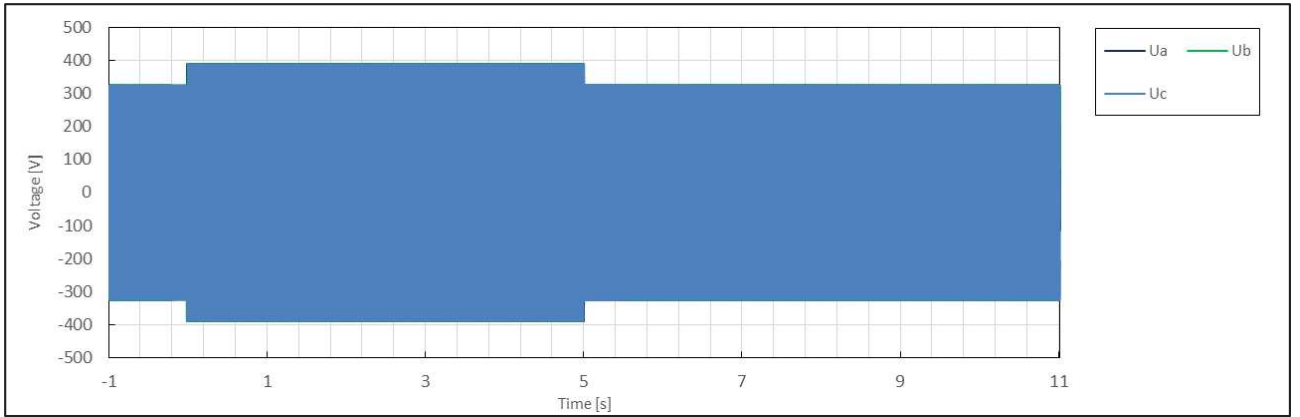

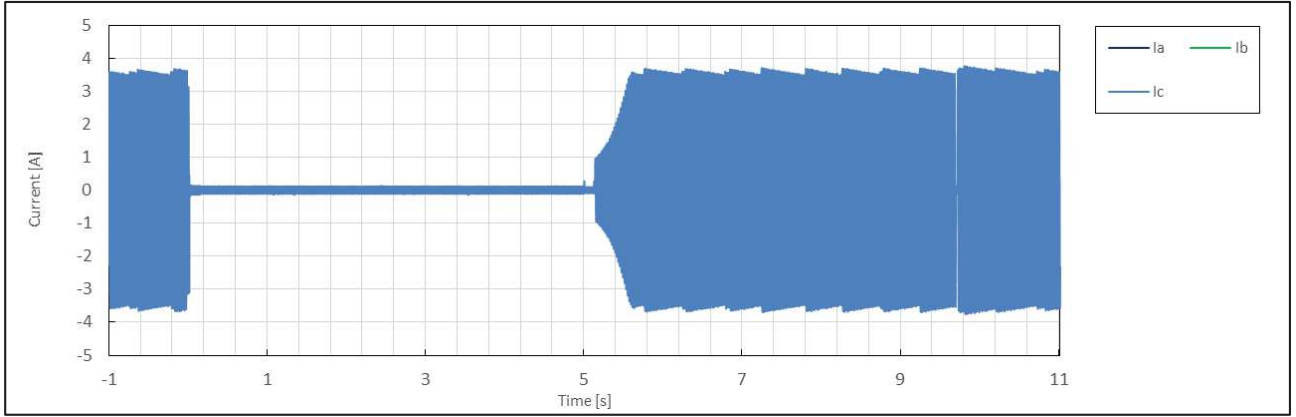
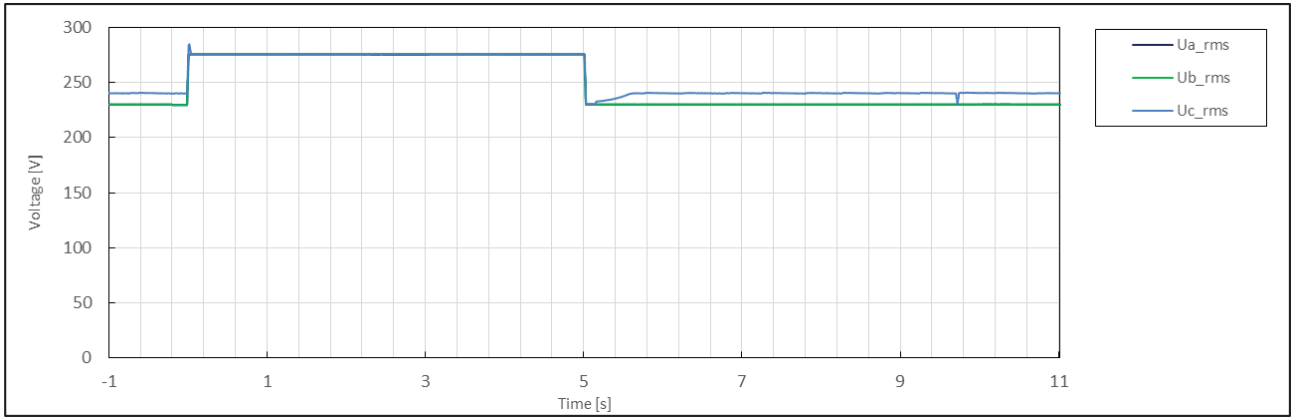
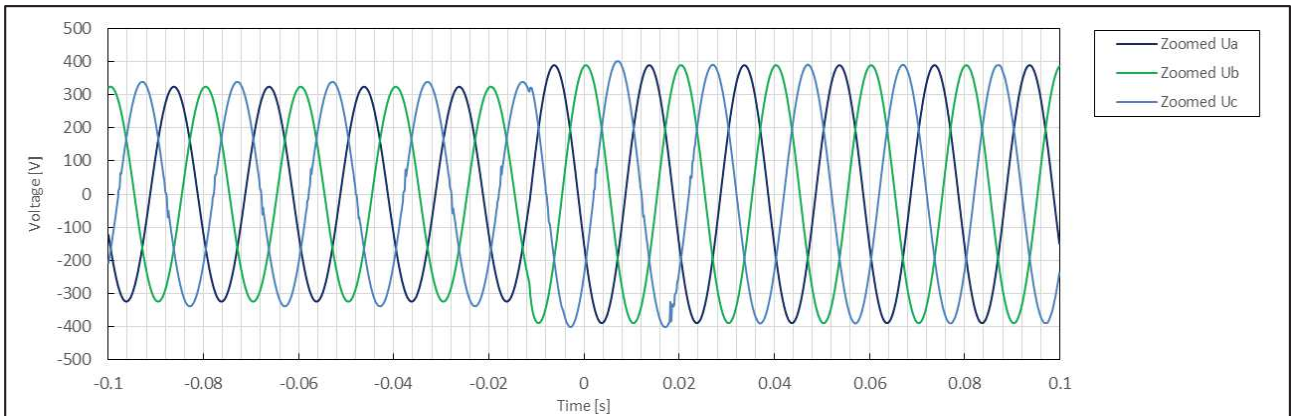
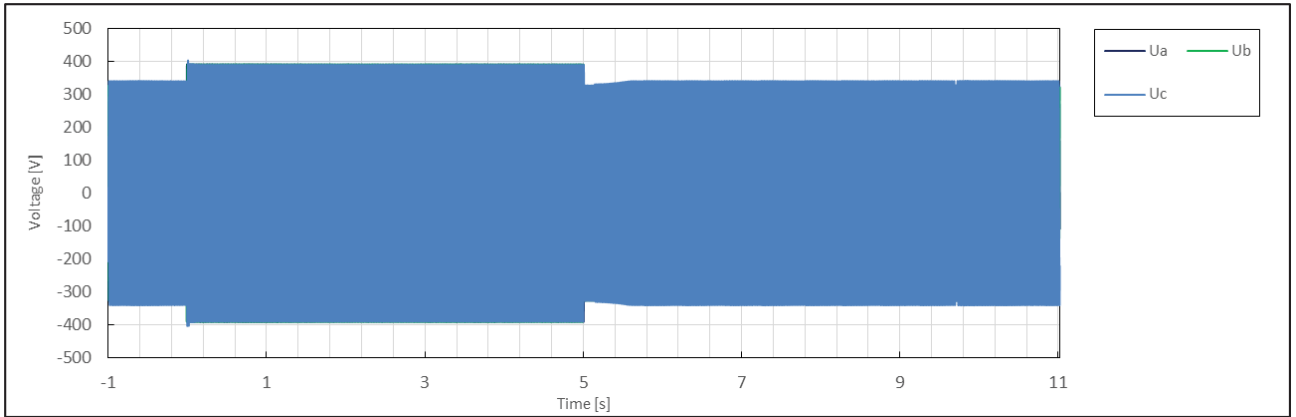

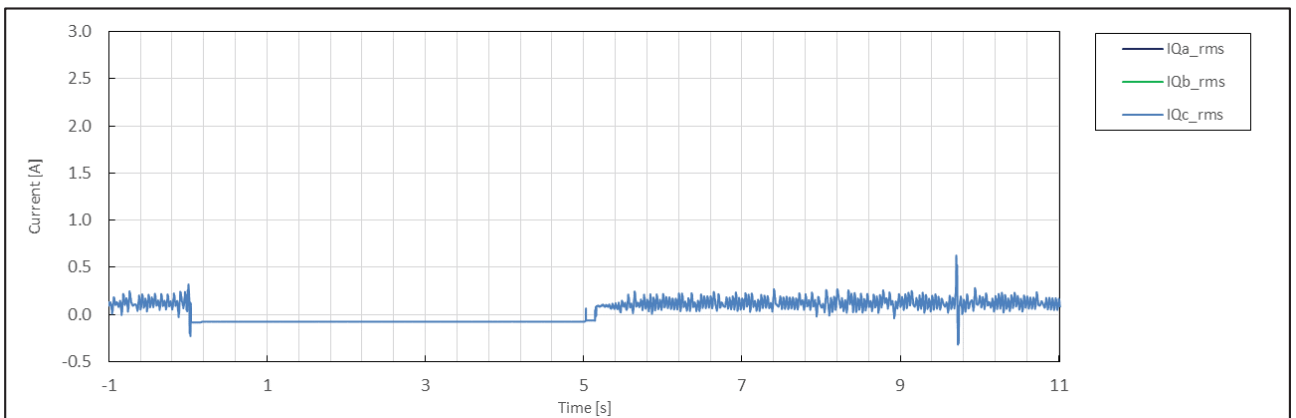
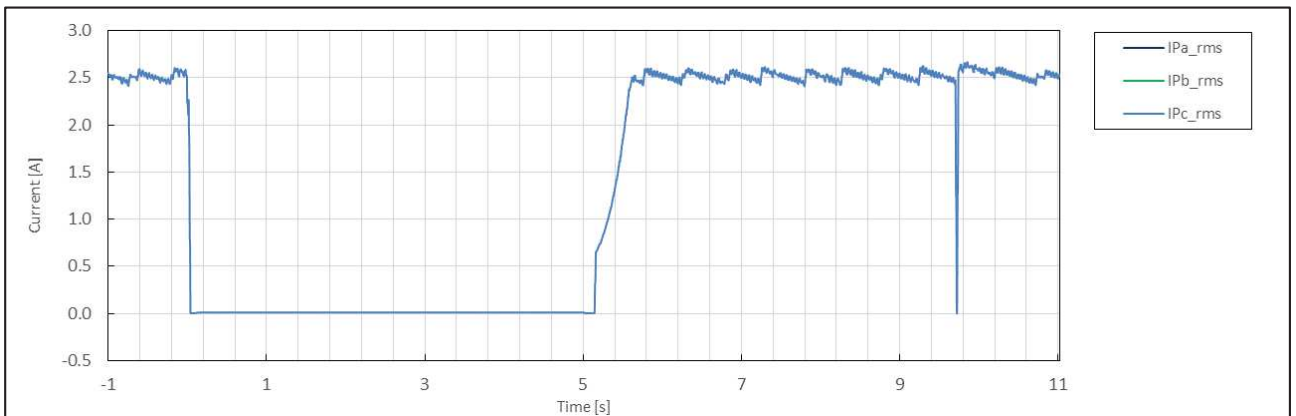
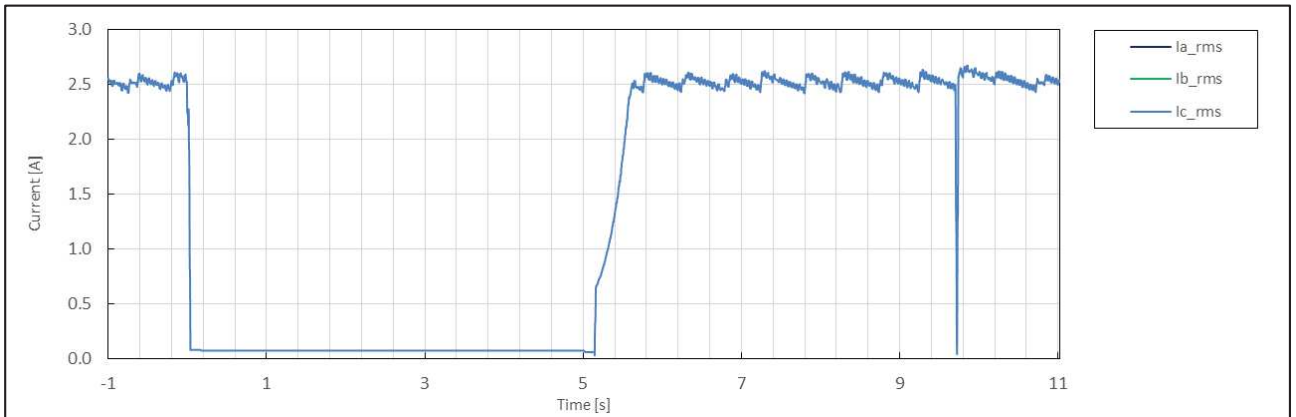
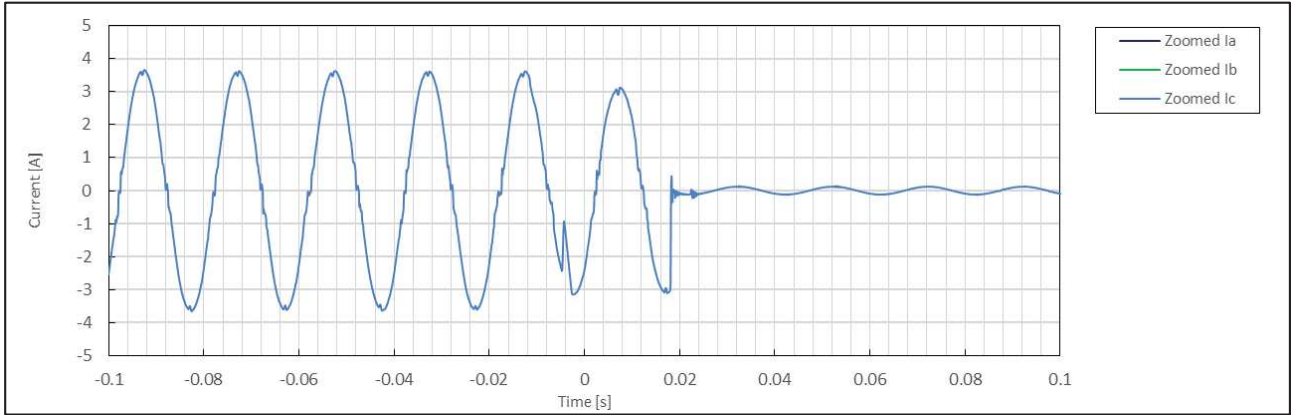

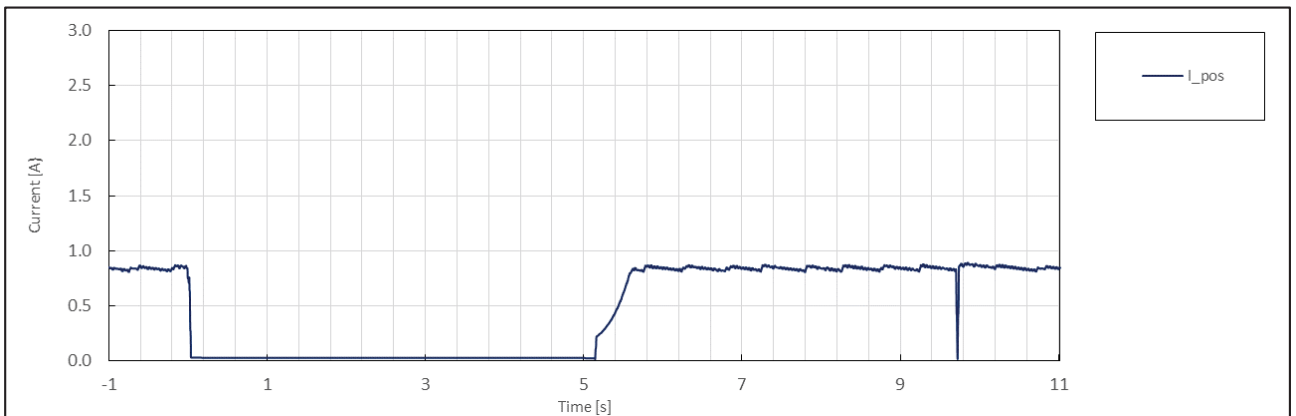
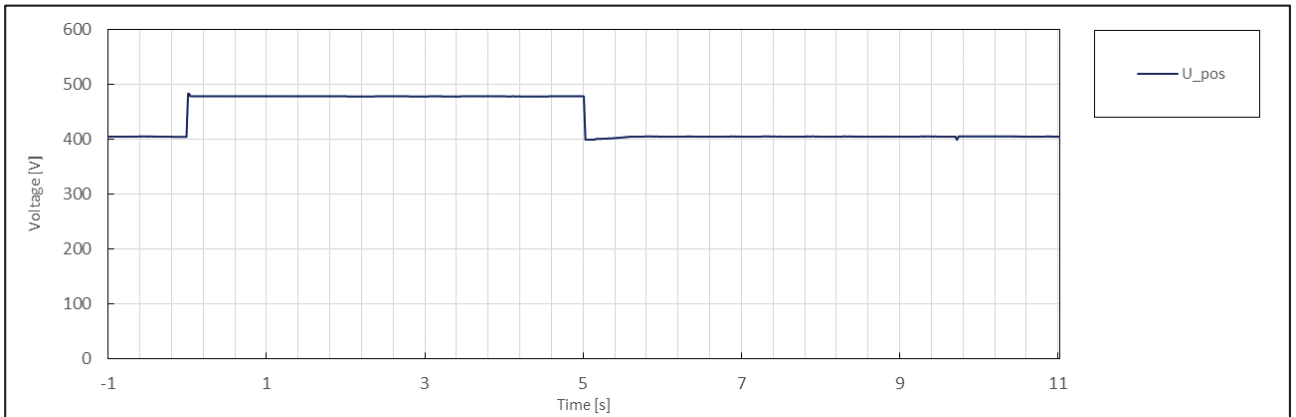
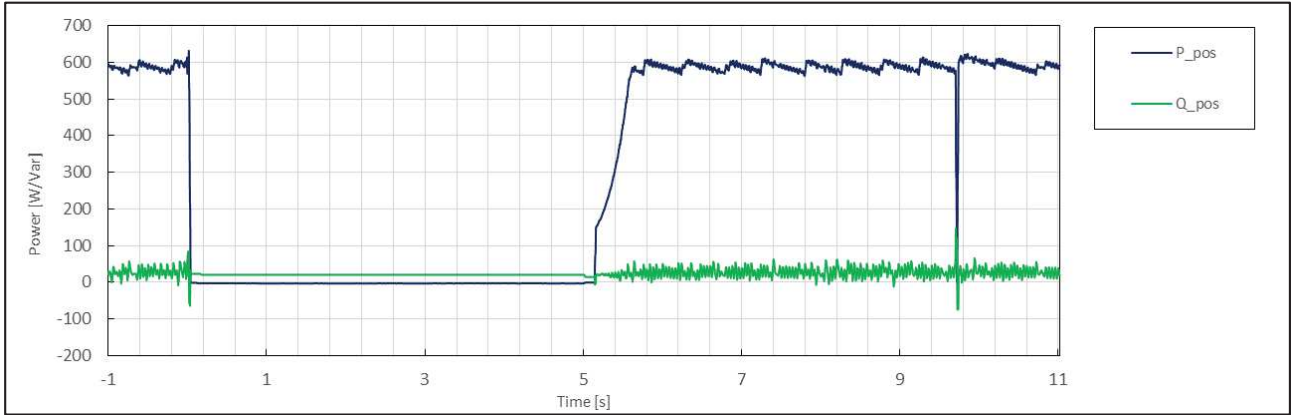

|                     | No. | Parameter  | Phase ref.      | Time ref.                       | unit       | Result        |
|---------------------|-----|--|-----------------|---------------------------------|------------|---------------|
| General Info.       | 0   | Test number  | --              | --                              | --         | 6.2           |
|                     | 1   | Date   | --              | --                              | dd.mm.yyyy | 3.1.2020      |
|                     | 2   | Time (start of test)                                   | --              | --                              | hh:mm:ss.f | 15:07:11      |
|                     | 3   | Fault type (phase)                                     | --              | --                              |            | 3-phase fault |
|                     | 4   | Setting voltage depth                                  | Line to line    | --                              | p.u.       | 1.20          |
|                     | 5   | Setting dip duration                                   |                 | --                              |            | 5018          |
|                     | 6   | Point of fault entry                                   | Total           | --                              | ms         | 0             |
|                     | 7   | Point of fault clearance                               | Total           | --                              | ms         | 5017          |
|                     | 8   | Fault duration in empty load test                      | Total           | --                              | ms         | 5018          |
|                     | 9   | Voltage depth/height in empty load test                | Total           | t1+100ms to t2 and t1-10s to t1 | p.u.       | 1.20          |
|                     | 10  |  | Pos.            |                                 | p.u.       | 1.20          |
| Before dip <t1      | 11  | Voltage  | Line to neutral | t1-100s to t1                   | p.u.       | 1.01          |
|                     | 12  | Current  | Pos.            | t1-500ms to t1-100ms            | p.u.       | 0.11          |
|                     | 13  | Active power   | Total           | t1-10s to t1                    | p.u.       | 0.33          |
|                     | 14  |  | Pos.            |                                 |            | 0.33          |
|                     | 15  | Reactive power   | Total           | t1-10s to t1                    | p.u.       | 0.04          |
|                     | 16  |  | Pos.            |                                 |            | 0.04          |
|                     | 17  | Cos $\varphi$  | --              | t1-10s to t1                    | --         | 0.994         |
| During dip t1 to t2 | 18  | Voltage  | Line to neutral | t1+100ms to t2-20ms             | p.u.       | 1.20          |
|                     | 19  | Line current   | Phase 1         | t1+60ms                         | p.u.       | N/A           |
|                     | 20  |  | Phase 2         |                                 |            | N/A           |
|                     | 21  |  | Phase 3         |                                 |            | 0.03          |
|                     | 22  | Line current   | Phase 1         | t1+100ms                        | p.u.       | N/A           |
|                     | 23  |  | Phase 2         |                                 |            | N/A           |
|                     | 24  |  | Phase 3         |                                 |            | 0.03          |
|                     | 25  | Active power   | Total           | t1+100ms to t2-20ms             | p.u.       | 0.00          |
|                     | 26  |  | Pos.            |                                 |            | 0.00          |
| After dip > t2      | 27  | Voltage  | Line to neutral | t2+3s to t2+10s                 | p.u.       | 1.01          |
|                     | 28  | Active power   | Total           | t2+3s to t2+10s                 | p.u.       | 0.33          |
|                     | 29  |  | Pos.            |                                 |            | 0.33          |
|                     | 39  | Active power rising time                               | Pos.            | --                              | s          | 0.197         |
|                     | 31  | Reactive power   | Total           | t2+3s to t2+10s                 | p.u.       | 0.04          |
|                     | 32  |  | Pos.            |                                 |            | 0.04          |
|                     | 33  | Reactive power rising time                             | Pos.            | --                              | s          | N/A           |
|                     | 34  | PGU does not disconnect from grid till 60s after fault | --              | t2 to t2+60s                    | Yes / No   | No            |

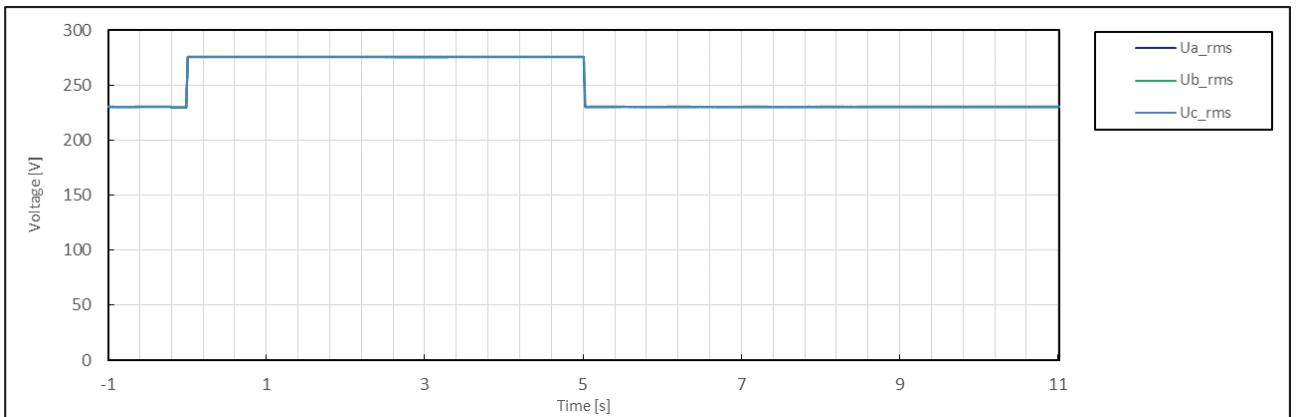
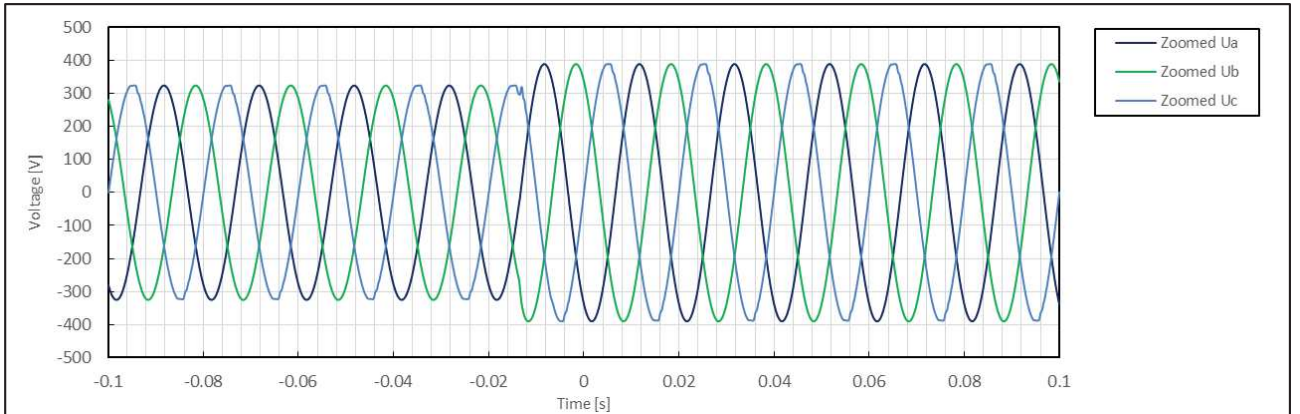
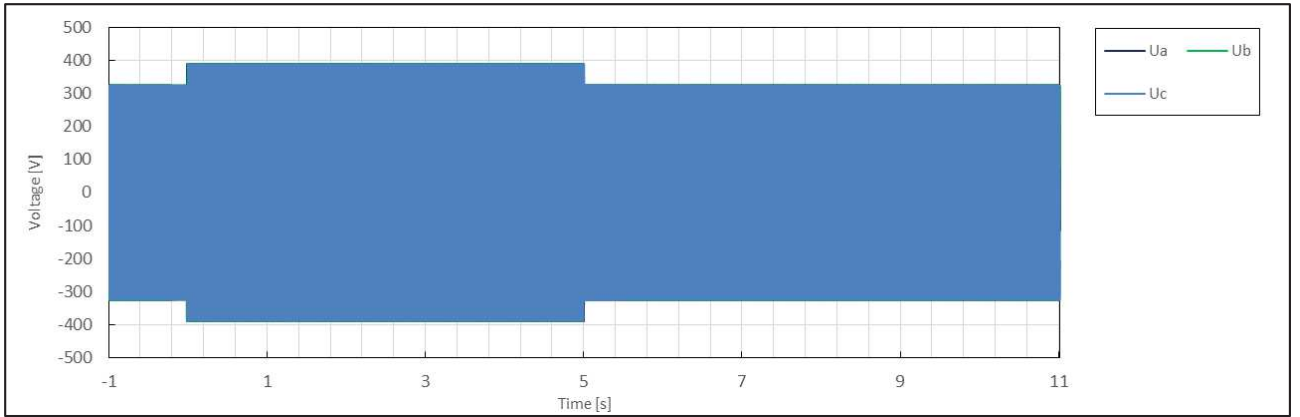

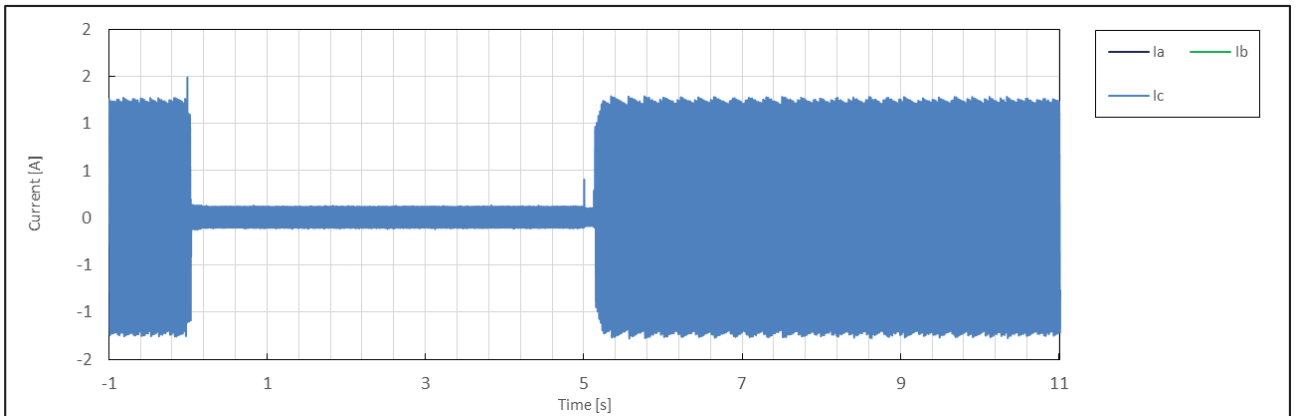
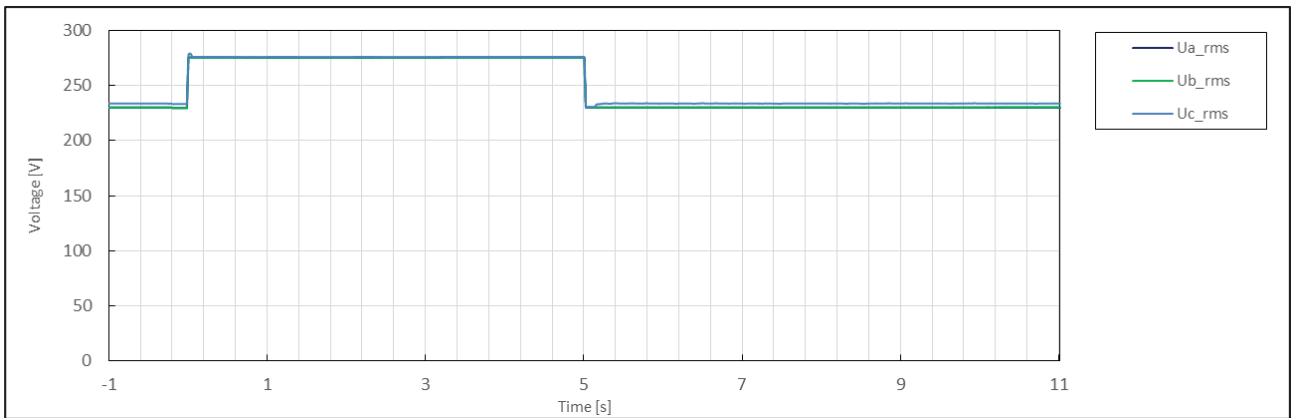
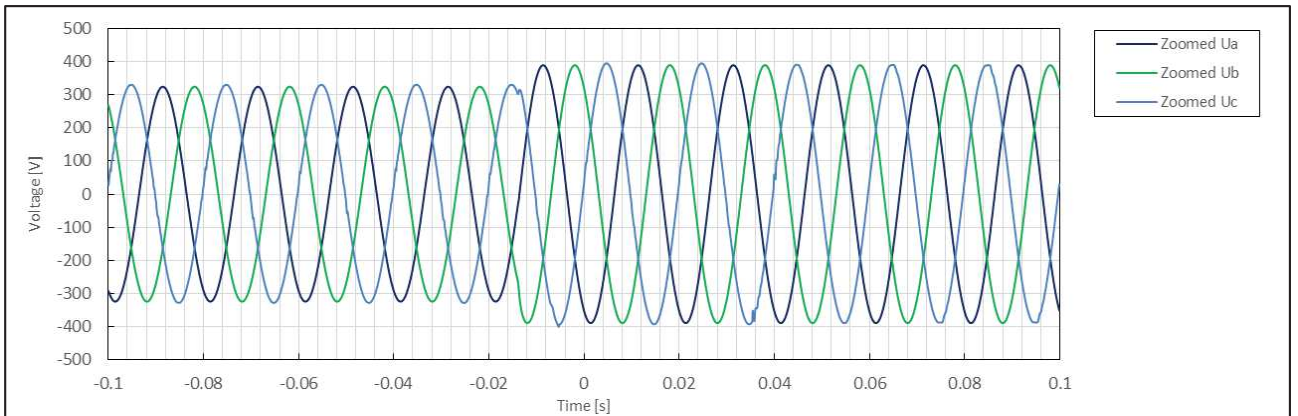
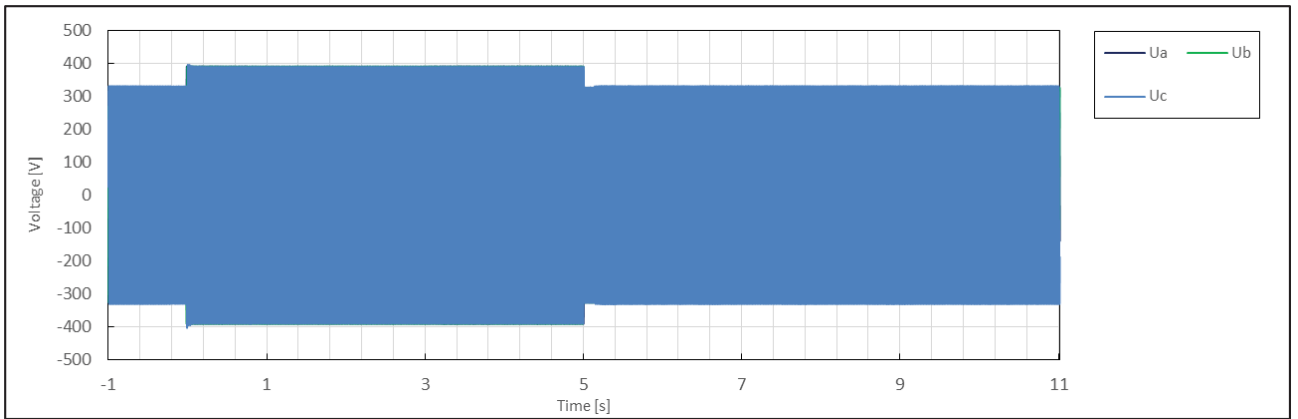



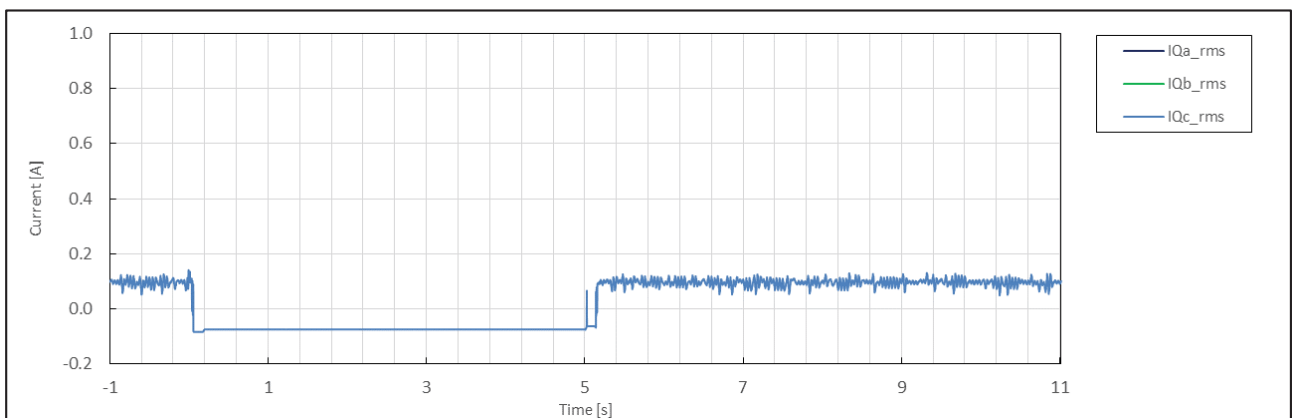
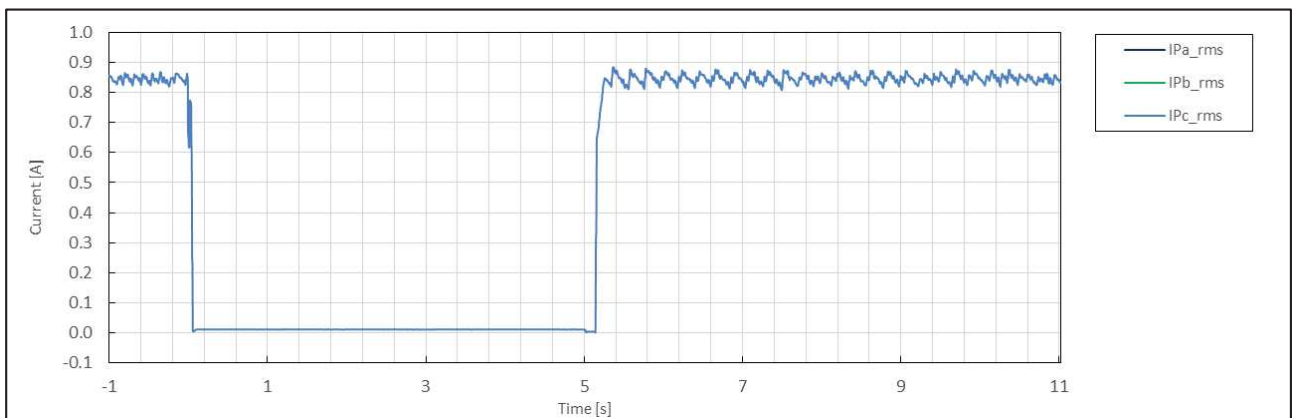
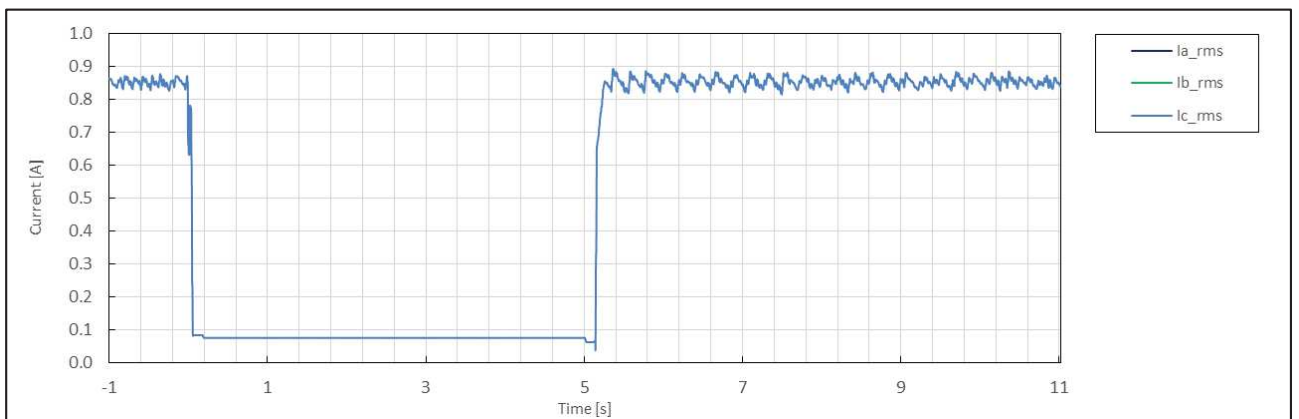
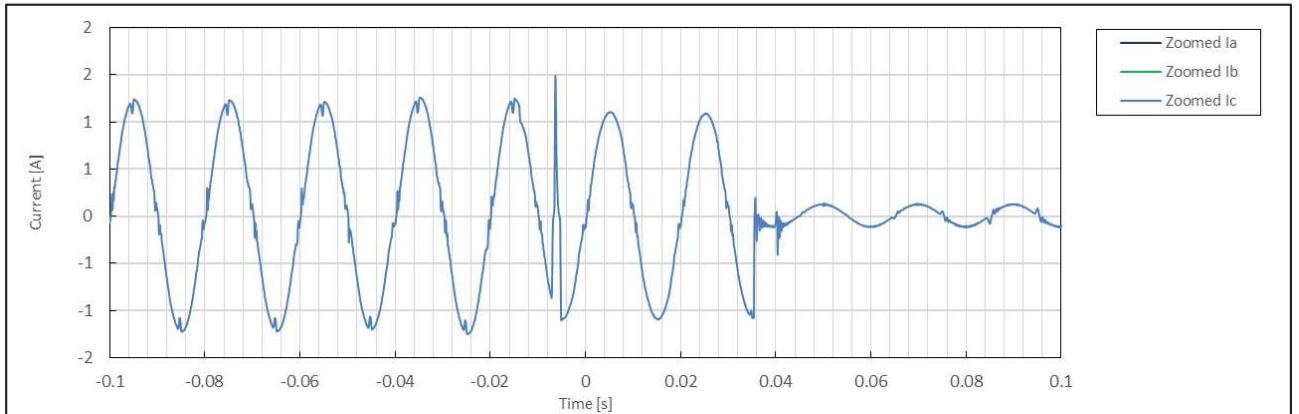

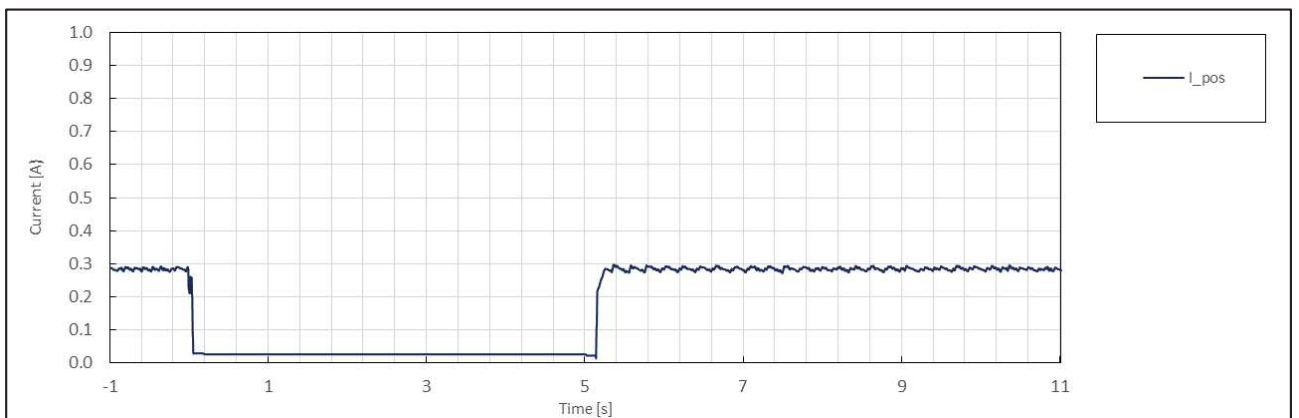
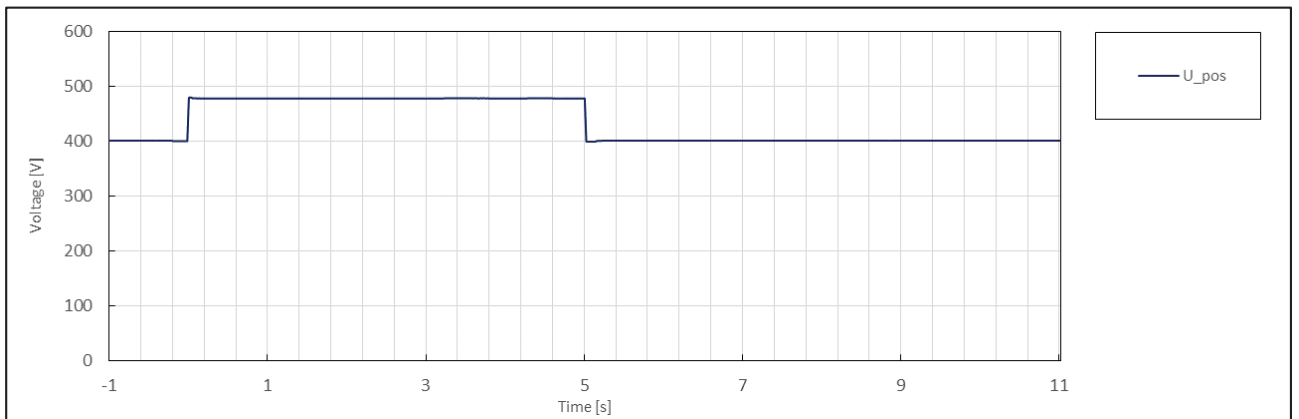
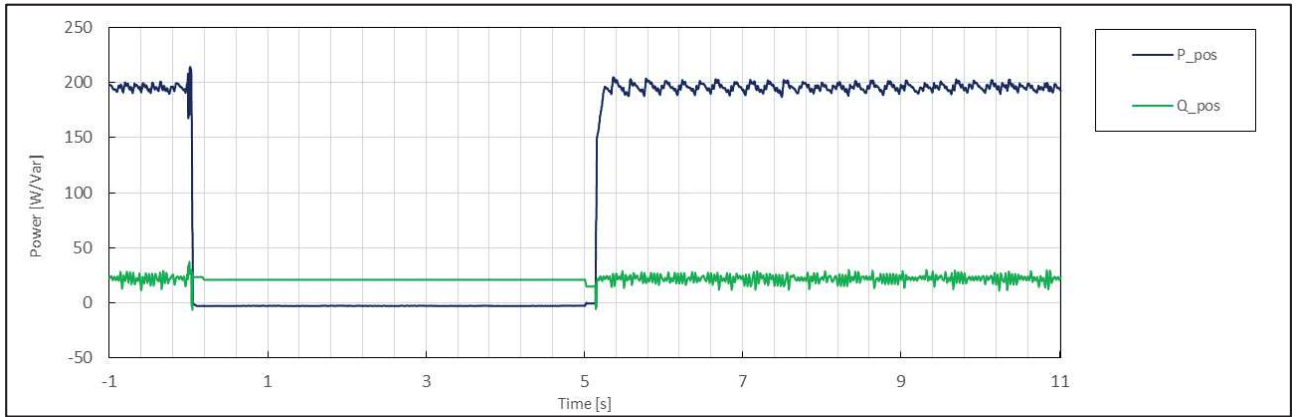

|                     | No. | Parameter  | Phase ref.      | Time ref.                       | unit       | Result        |
|---------------------|-----|--|-----------------|---------------------------------|------------|---------------|
| General Info.       | 0   | Test number  | --              | --                              | --         | 6.3           |
|                     | 1   | Date   | --              | --                              | dd.mm.yyyy | 3.1.2020      |
|                     | 2   | Time (start of test)                                   | --              | --                              | hh:mm:ss.f | 15:11:17      |
|                     | 3   | Fault type (phase)                                     | --              | --                              |            | 2-phase fault |
|                     | 4   | Setting voltage depth                                  | Line to line    | --                              | p.u.       | 1.20          |
|                     | 5   | Setting dip duration                                   |                 | --                              |            | 5018          |
|                     | 6   | Point of fault entry                                   | Total           | --                              | ms         | 0             |
|                     | 7   | Point of fault clearance                               | Total           | --                              | ms         | 5017          |
|                     | 8   | Fault duration in empty load test                      | Total           | --                              | ms         | 5018          |
|                     | 9   | Voltage depth/height in empty load test                | Total           | t1+100ms to t2 and t1-10s to t1 | p.u.       | 1.05          |
|                     | 10  |  | Pos.            |                                 | p.u.       | 1.10          |
| Before dip <t1      | 11  | Voltage  | Line to neutral | t1-100s to t1                   | p.u.       | 1.02          |
|                     | 12  | Current  | Pos.            | t1-500ms to t1-100ms            | p.u.       | 0.32          |
|                     | 13  | Active power   | Total           | t1-10s to t1                    | p.u.       | 1.01          |
|                     | 14  |  | Pos.            |                                 |            | 0.98          |
|                     | 15  | Reactive power   | Total           | t1-10s to t1                    | p.u.       | 0.05          |
|                     | 16  |  | Pos.            |                                 |            | 0.05          |
|                     | 17  | Cos $\phi$   | --              | t1-10s to t1                    | --         | 0.999         |
| During dip t1 to t2 | 18  | Voltage  | Line to neutral | t1+100ms to t2-20ms             | p.u.       | 1.09          |
|                     | 19  | Line current   | Phase 1         | t1+60ms                         | p.u.       | N/A           |
|                     | 20  |  | Phase 2         |                                 |            | N/A           |
|                     | 21  |  | Phase 3         |                                 |            | 0.92          |
|                     | 22  | Line current   | Phase 1         | t1+100ms                        | p.u.       | N/A           |
|                     | 23  |  | Phase 2         |                                 |            | N/A           |
|                     | 24  |  | Phase 3         |                                 |            | 0.91          |
|                     | 25  | Active power   | Total           | t1+100ms to t2-20ms             | p.u.       | 1.01          |
|                     | 26  |  | Pos.            |                                 |            | 1.02          |
| After dip > t2      | 27  | Voltage  | Line to neutral | t2+3s to t2+10s                 | p.u.       | 1.02          |
|                     | 28  | Active power   | Total           | t2+3s to t2+10s                 | p.u.       | 1.01          |
|                     | 29  |  | Pos.            |                                 |            | 0.98          |
|                     | 39  | Active power rising time                               | Pos.            | --                              | s          | N/A           |
|                     | 31  | Reactive power   | Total           | t2+3s to t2+10s                 | p.u.       | 0.05          |
|                     | 32  |  | Pos.            |                                 |            | 0.05          |
|                     | 33  | Reactive power rising time                             | Pos.            | --                              | s          | N/A           |
|                     | 34  | PGU does not disconnect from grid till 60s after fault | --              | t2 to t2+60s                    | Yes / No   | No            |

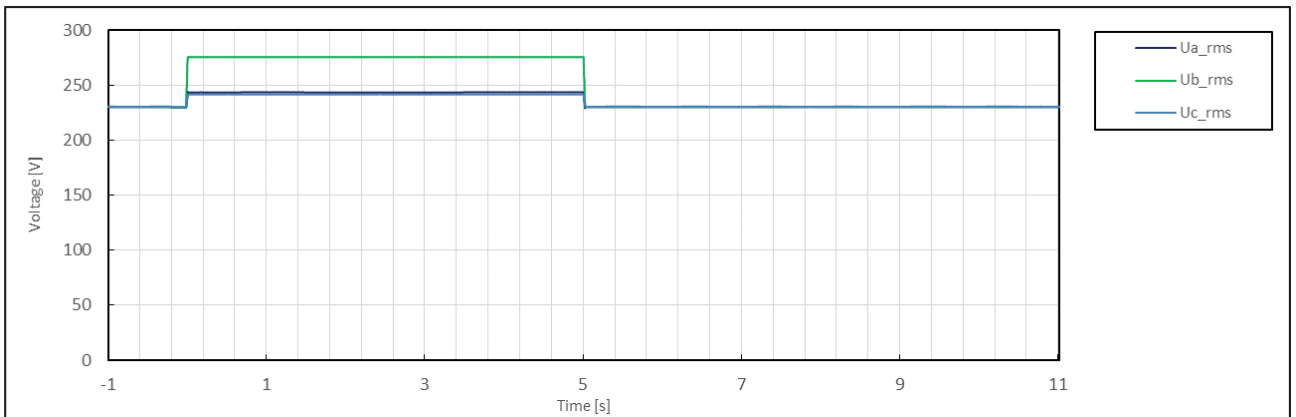
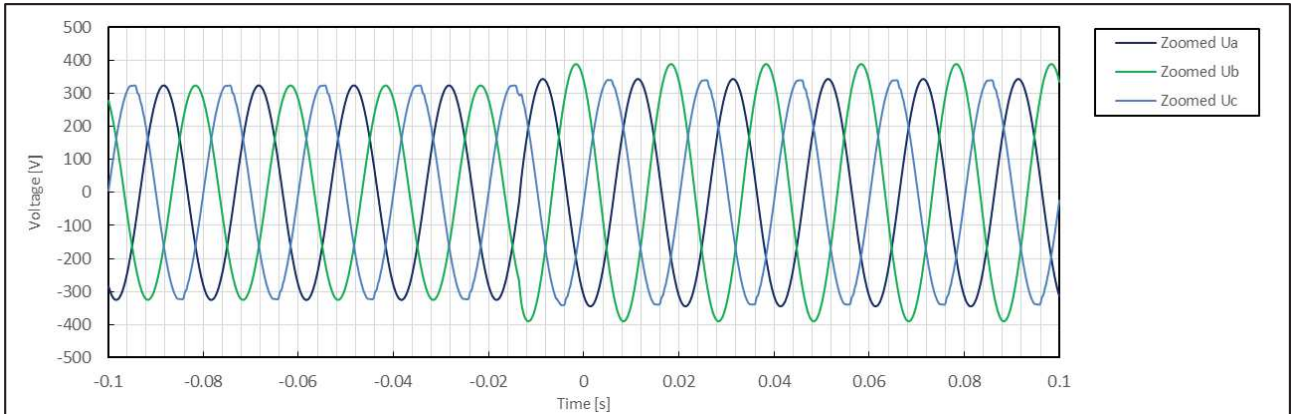
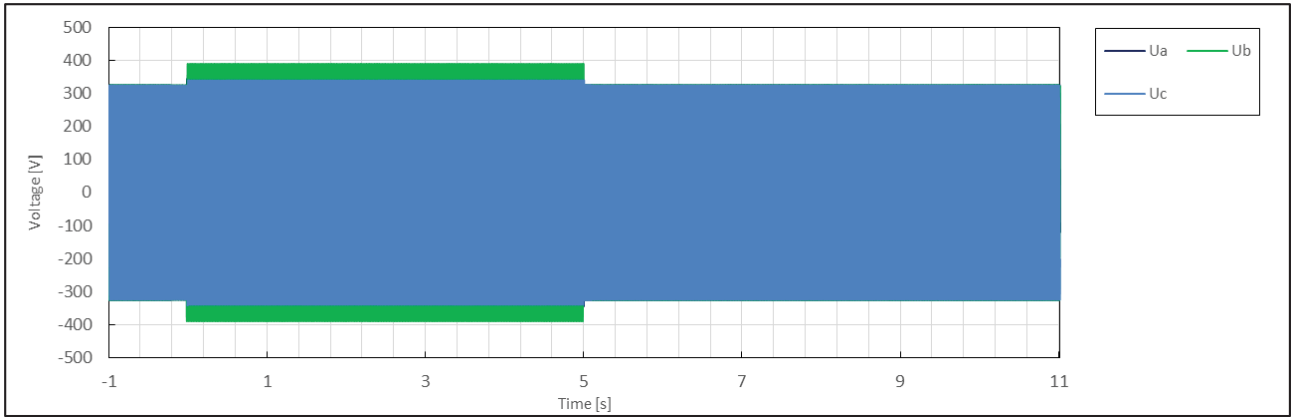

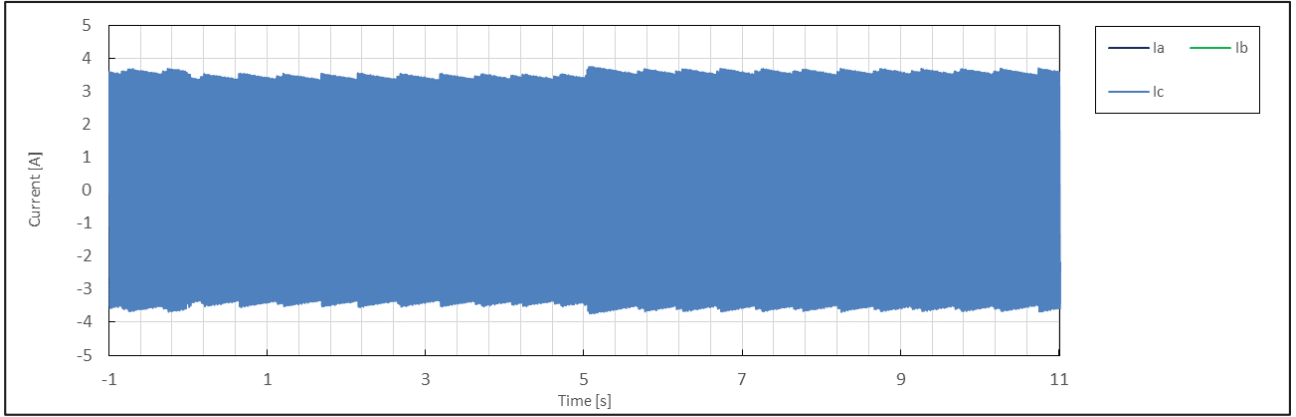
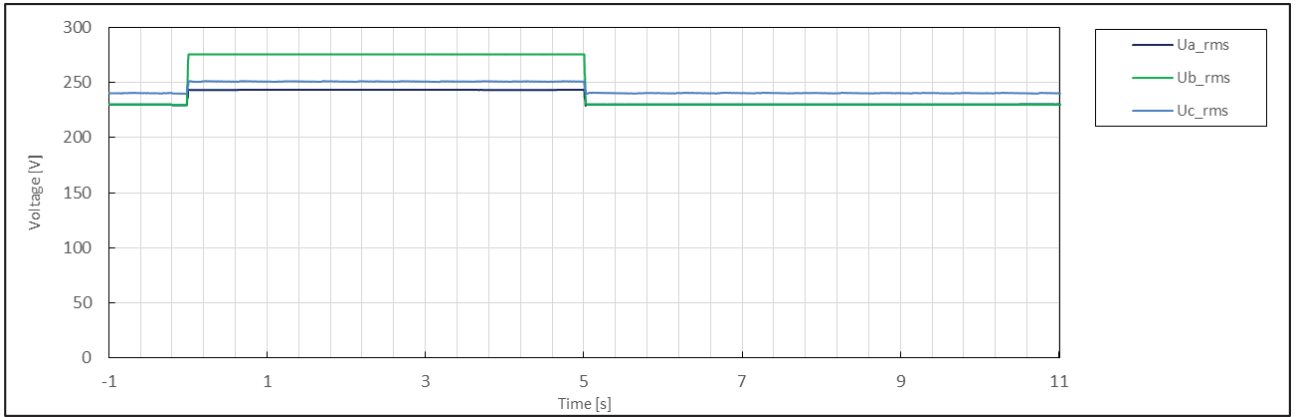
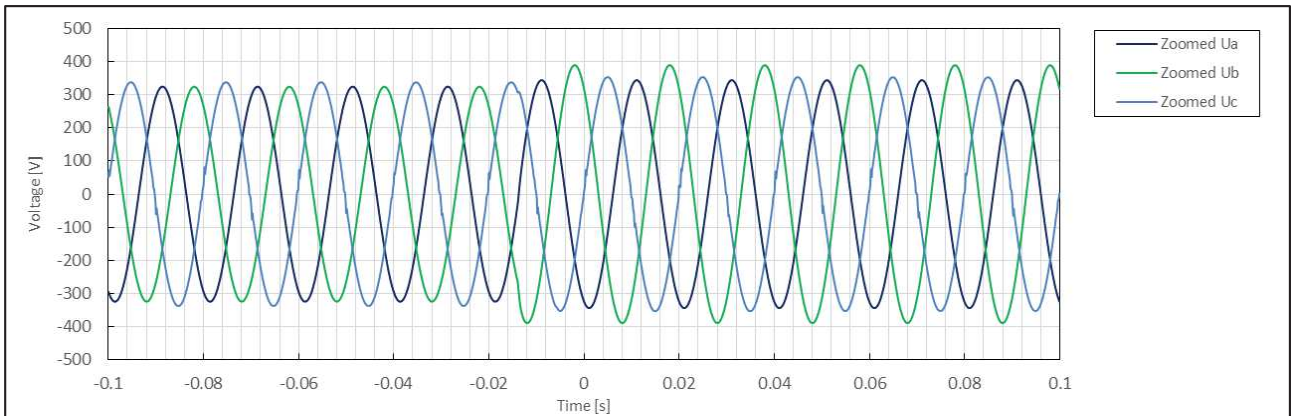
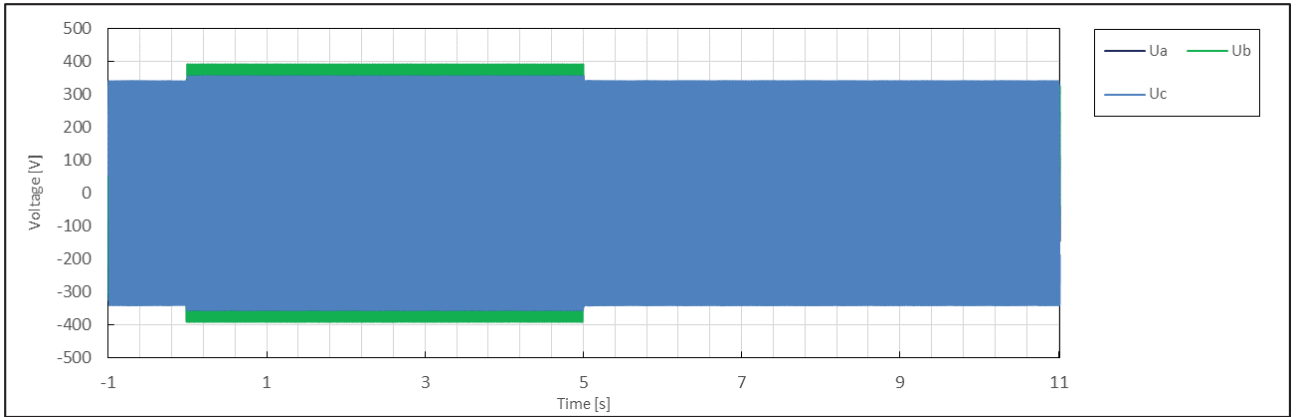

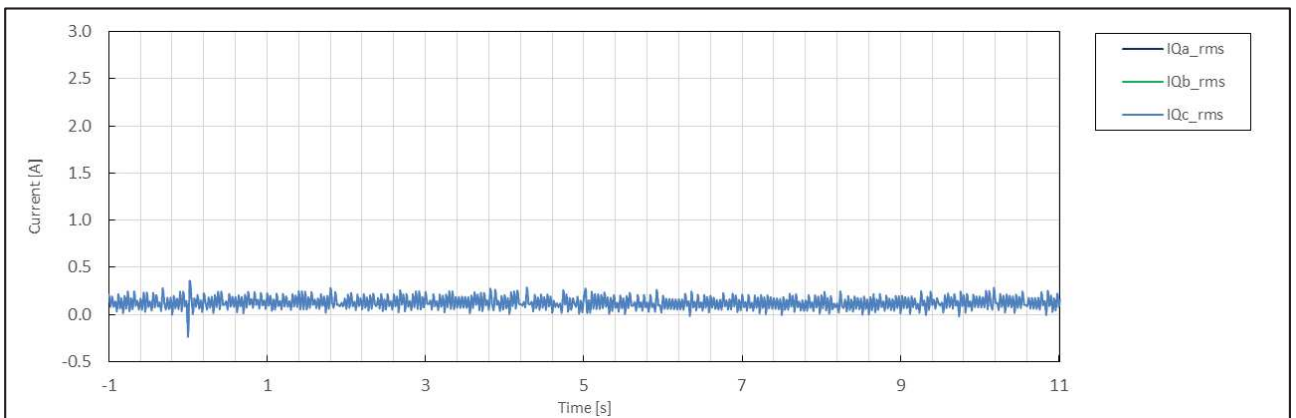
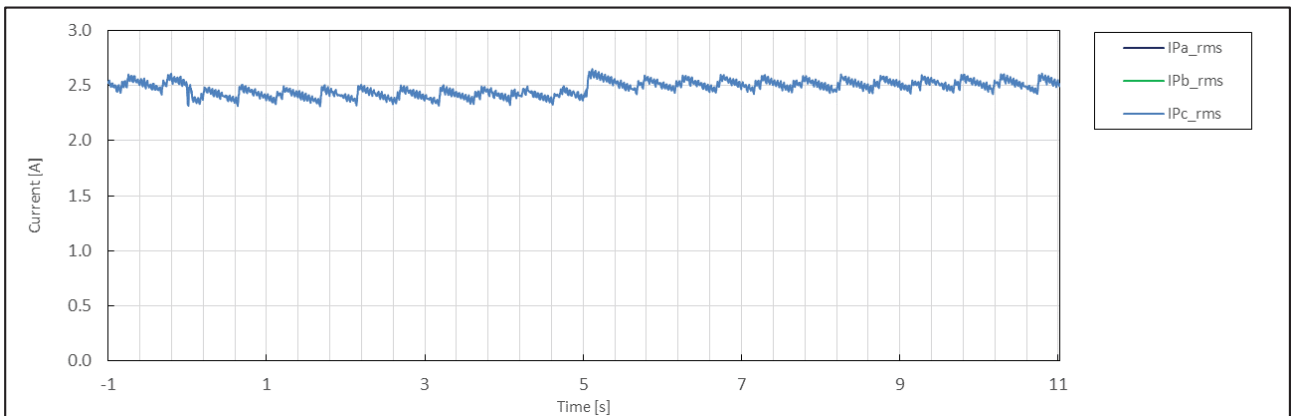
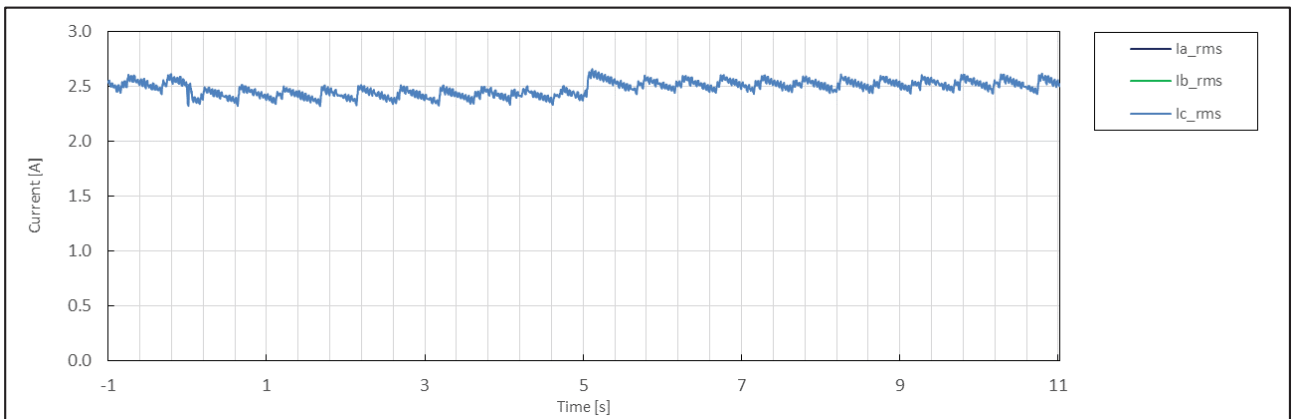
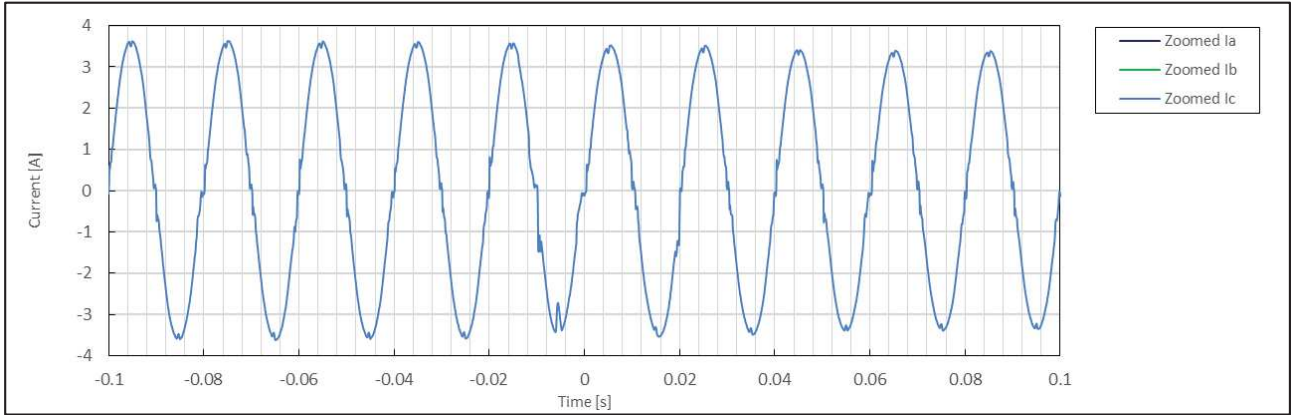

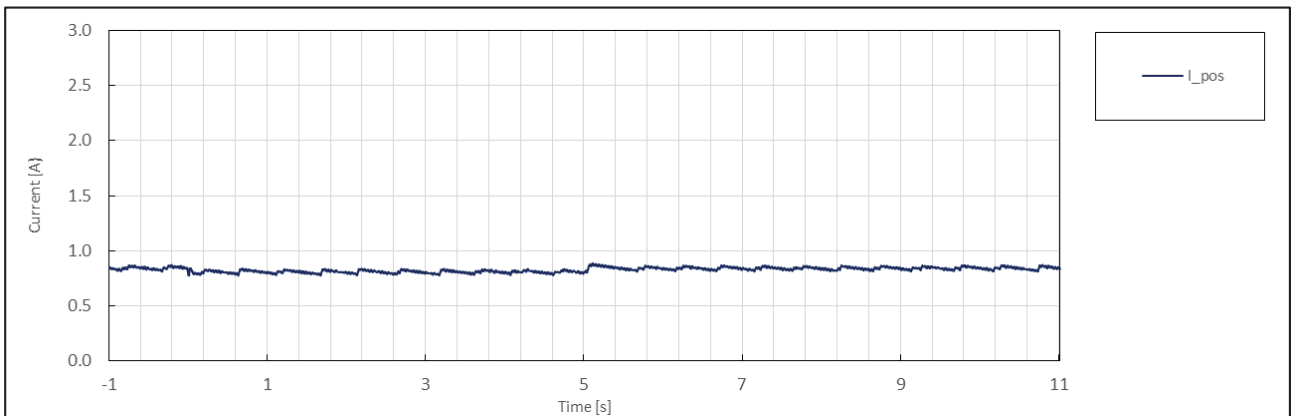
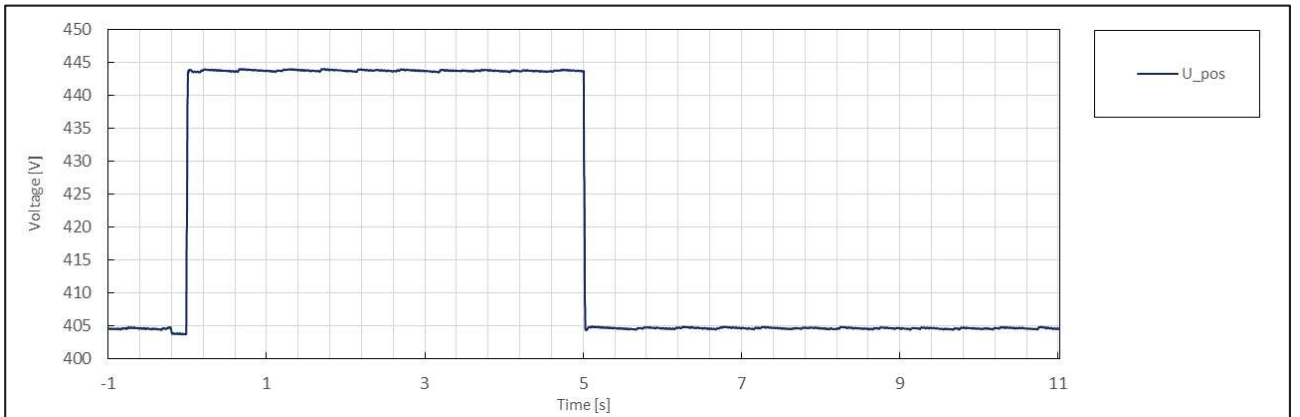
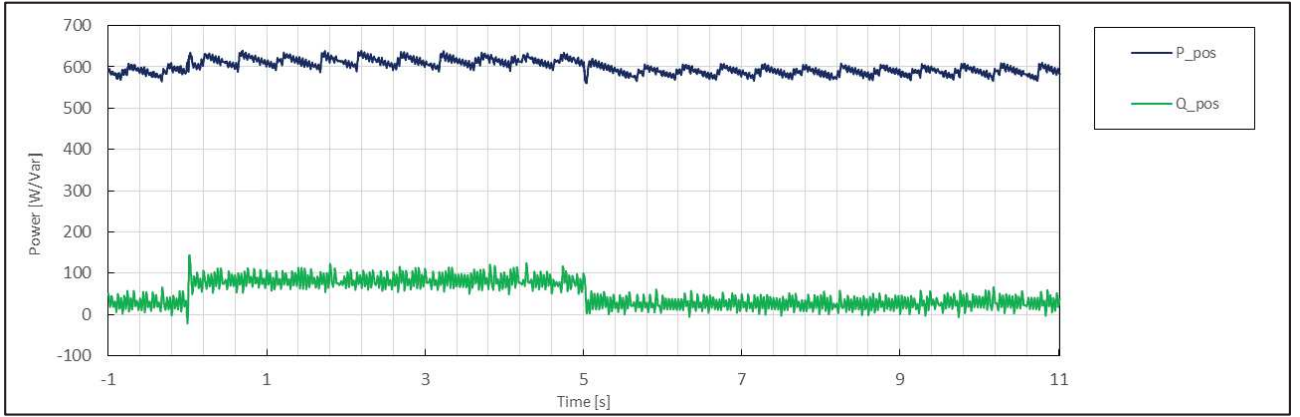

|                     | No. | Parameter  | Phase ref.      | Time ref.                       | unit       | Result        |
|---------------------|-----|--|-----------------|---------------------------------|------------|---------------|
| General Info.       | 0   | Test number  | --              | --                              | --         | 6.4           |
|                     | 1   | Date   | --              | --                              | dd.mm.yyyy | 3.1.2020      |
|                     | 2   | Time (start of test)                                   | --              | --                              | hh:mm:ss.f | 15:14:29      |
|                     | 3   | Fault type (phase)                                     | --              | --                              |            | 2-phase fault |
|                     | 4   | Setting voltage depth                                  | Line to line    | --                              | p.u.       | 1.20          |
|                     | 5   | Setting dip duration                                   |                 | --                              |            | 5018          |
|                     | 6   | Point of fault entry                                   | Total           | --                              | ms         | 0             |
|                     | 7   | Point of fault clearance                               | Total           | --                              | ms         | 5017          |
|                     | 8   | Fault duration in empty load test                      | Total           | --                              | ms         | 5018          |
|                     | 9   | Voltage depth/height in empty load test                | Total           | t1+100ms to t2 and t1-10s to t1 | p.u.       | 1.05          |
|                     | 10  |  | Pos.            |                                 | p.u.       | 1.10          |
| Before dip <t1      | 11  | Voltage  | Line to neutral | t1-100s to t1                   | p.u.       | 1.01          |
|                     | 12  | Current  | Pos.            | t1-500ms to t1-100ms            | p.u.       | 0.11          |
|                     | 13  | Active power   | Total           | t1-10s to t1                    | p.u.       | 0.33          |
|                     | 14  |  | Pos.            |                                 |            | 0.33          |
|                     | 15  | Reactive power   | Total           | t1-10s to t1                    | p.u.       | 0.04          |
|                     | 16  |  | Pos.            |                                 |            | 0.04          |
|                     | 17  | Cos $\varphi$  | --              | t1-10s to t1                    | --         | 0.994         |
| During dip t1 to t2 | 18  | Voltage  | Line to neutral | t1+100ms to t2-20ms             | p.u.       | 1.06          |
|                     | 19  | Line current   | Phase 1         | t1+60ms                         | p.u.       | N/A           |
|                     | 20  |  | Phase 2         |                                 |            | N/A           |
|                     | 21  |  | Phase 3         |                                 |            | 0.29          |
|                     | 22  | Line current   | Phase 1         | t1+100ms                        | p.u.       | N/A           |
|                     | 23  |  | Phase 2         |                                 |            | N/A           |
|                     | 24  |  | Phase 3         |                                 |            | 0.31          |
|                     | 25  | Active power   | Total           | t1+100ms to t2-20ms             | p.u.       | 0.33          |
|                     | 26  |  | Pos.            |                                 |            | 0.34          |
| After dip > t2      | 27  | Voltage  | Line to neutral | t2+3s to t2+10s                 | p.u.       | 1.01          |
|                     | 28  | Active power   | Total           | t2+3s to t2+10s                 | p.u.       | 0.33          |
|                     | 29  |  | Pos.            |                                 |            | 0.33          |
|                     | 39  | Active power rising time                               | Pos.            | --                              | s          | N/A           |
|                     | 31  | Reactive power   | Total           | t2+3s to t2+10s                 | p.u.       | 0.04          |
|                     | 32  |  | Pos.            |                                 |            | 0.04          |
|                     | 33  | Reactive power rising time                             | Pos.            | --                              | s          | N/A           |
|                     | 34  | PGU does not disconnect from grid till 60s after fault | --              | t2 to t2+60s                    | Yes / No   | No            |



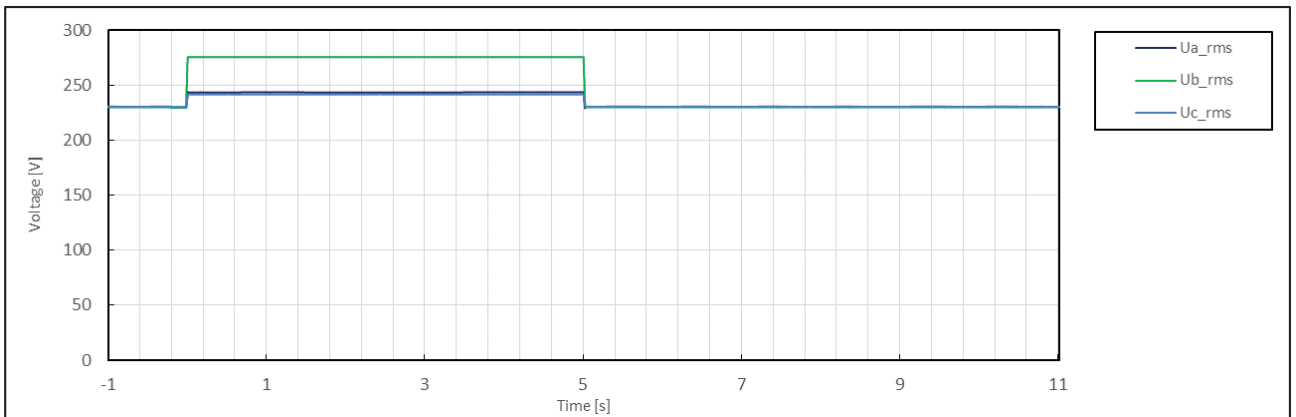
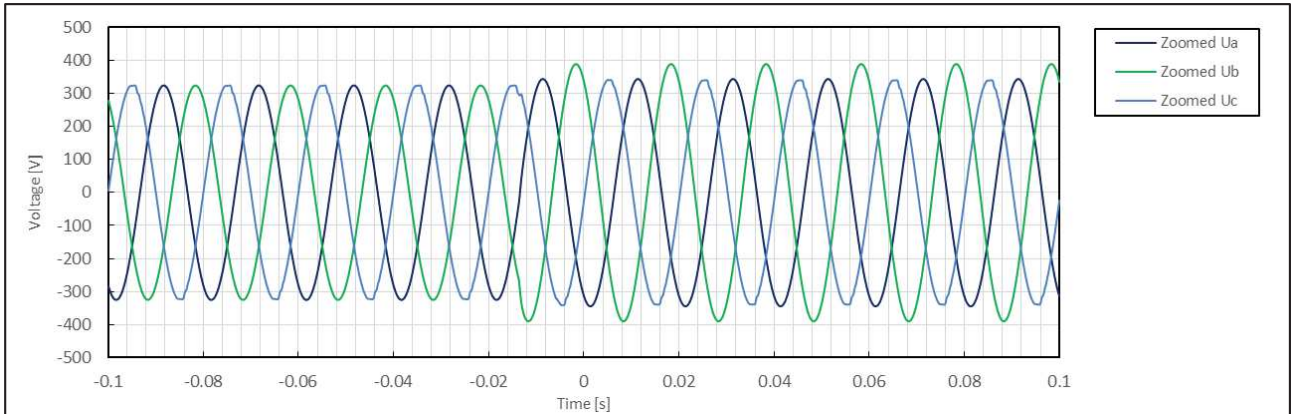
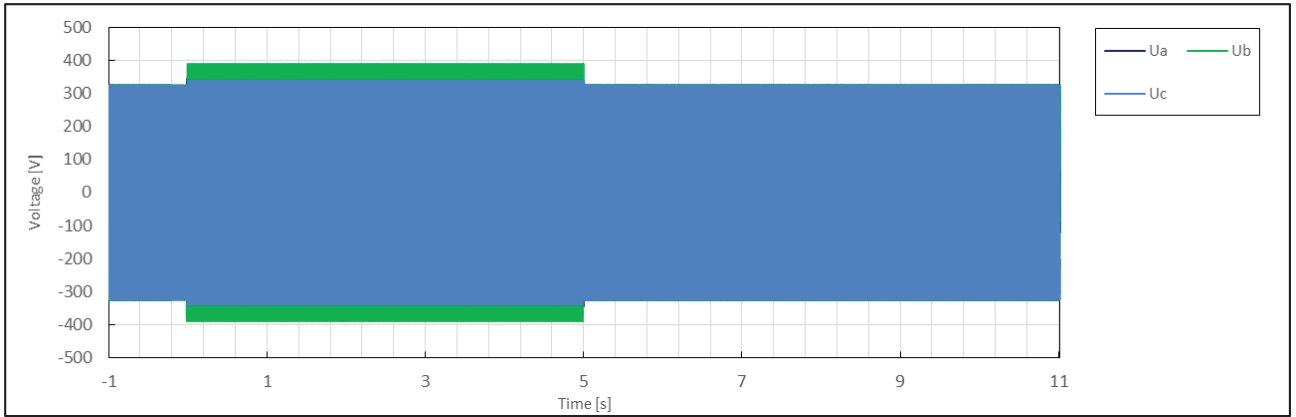

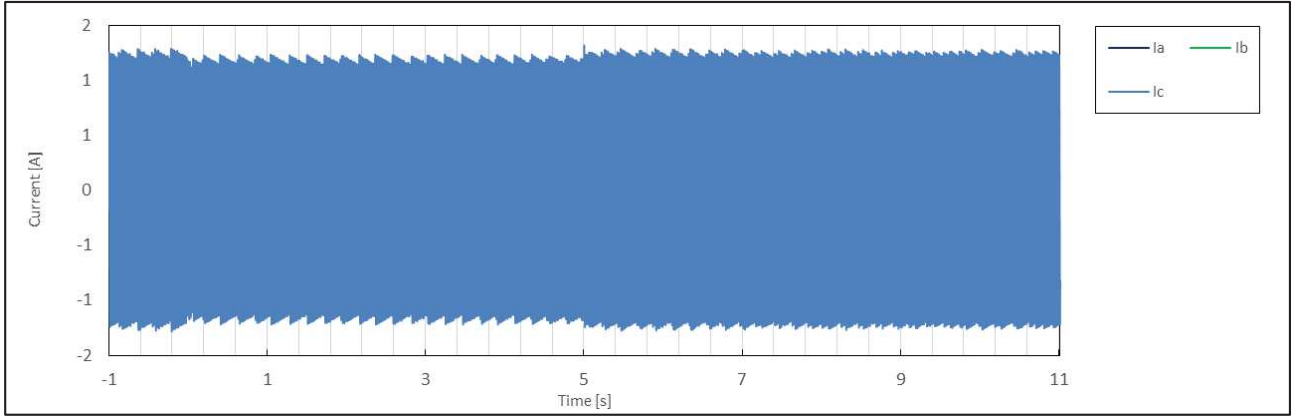
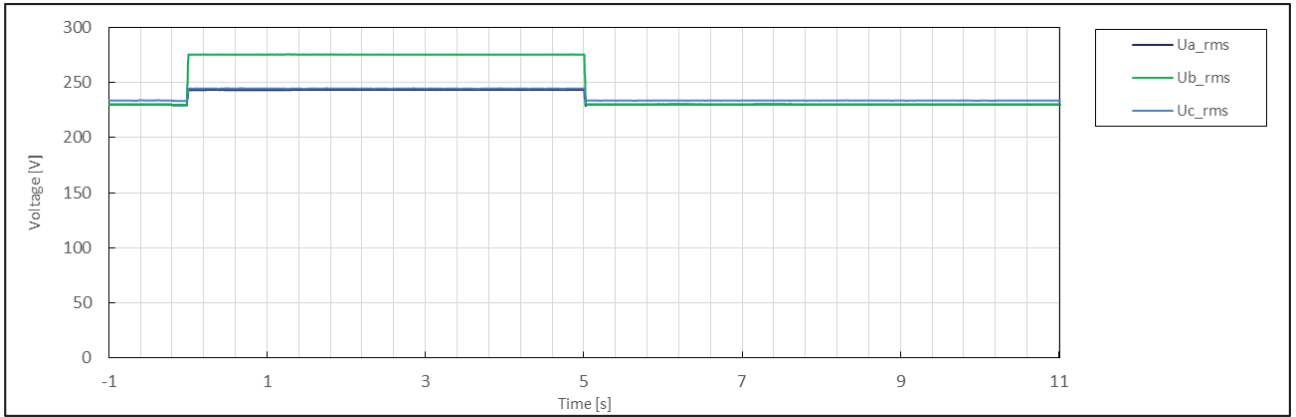
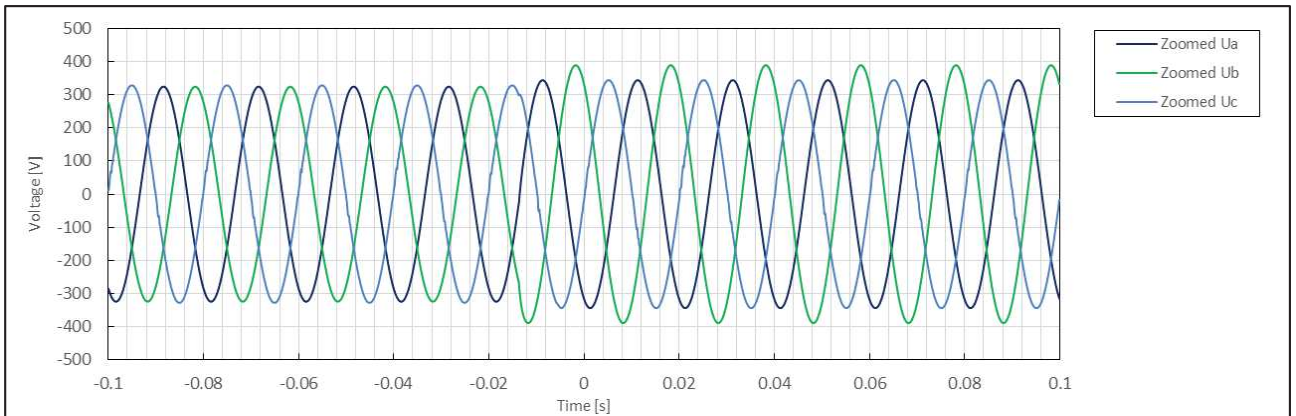
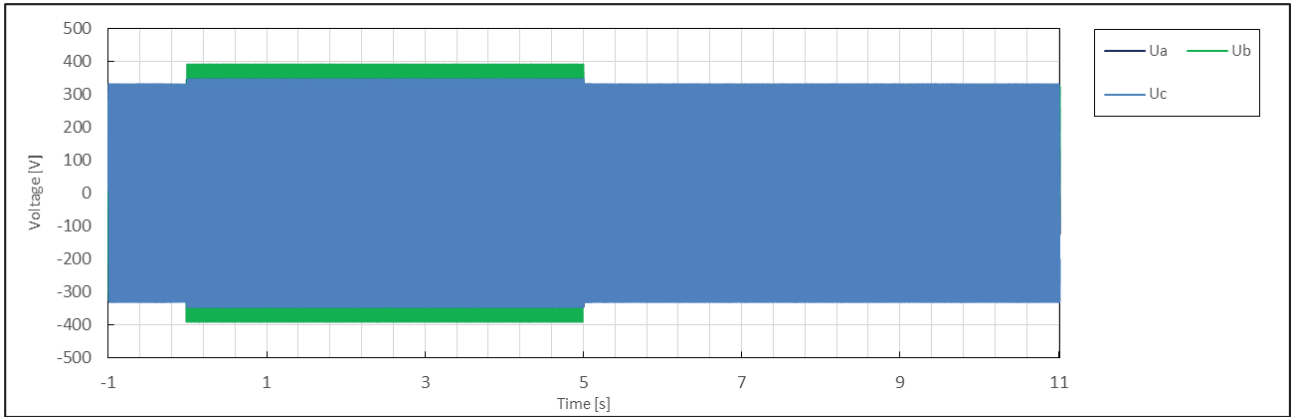

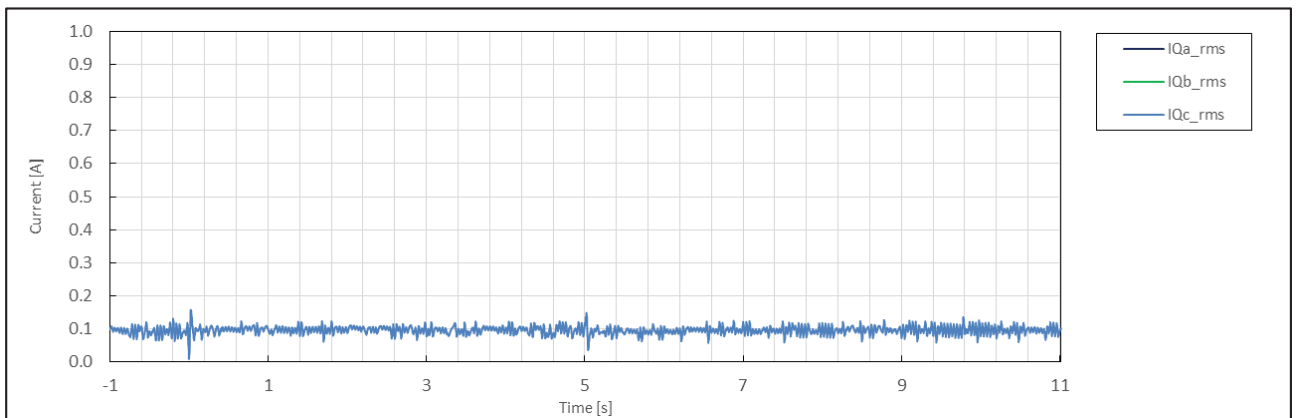
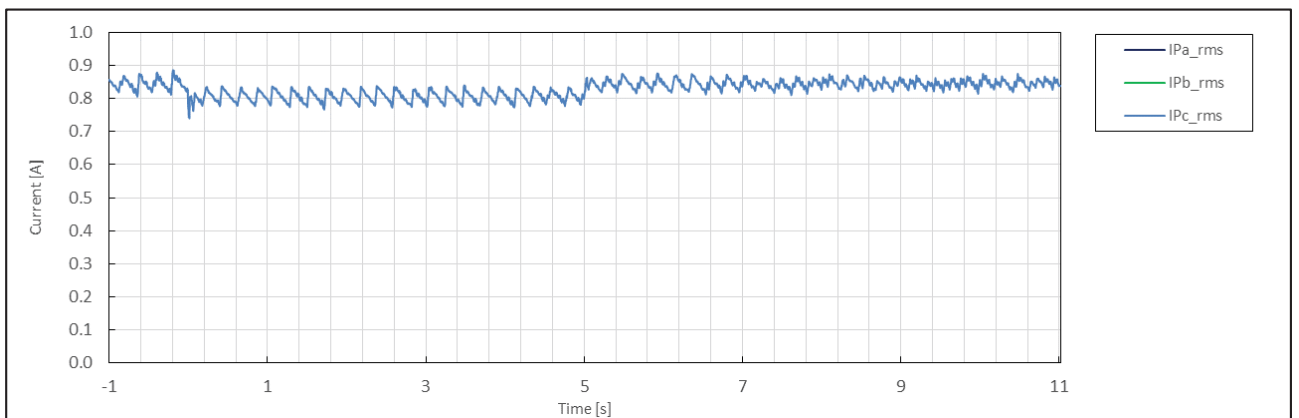
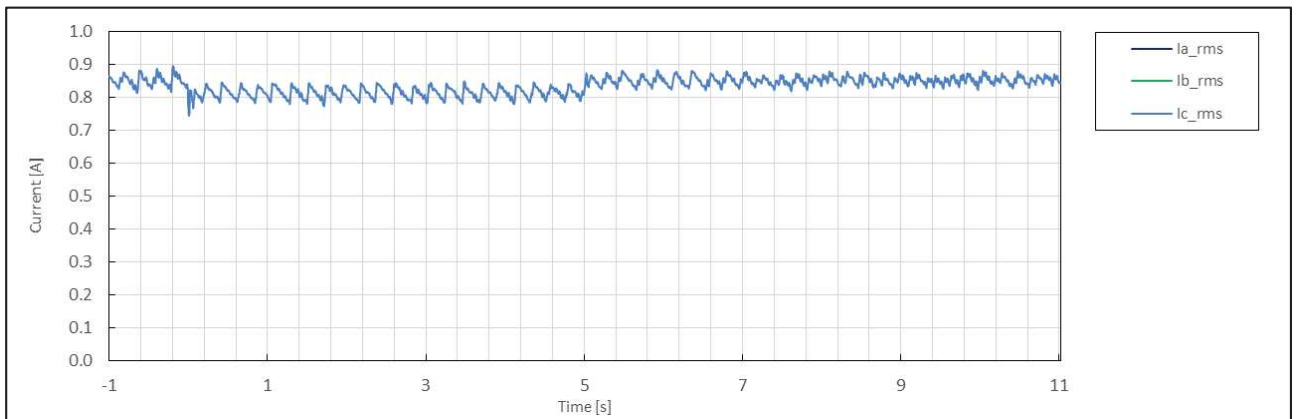
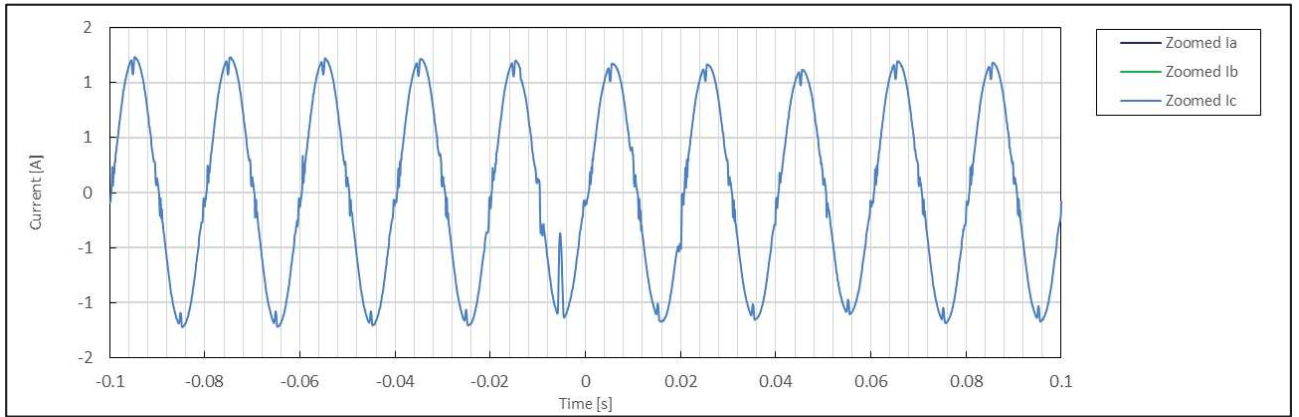

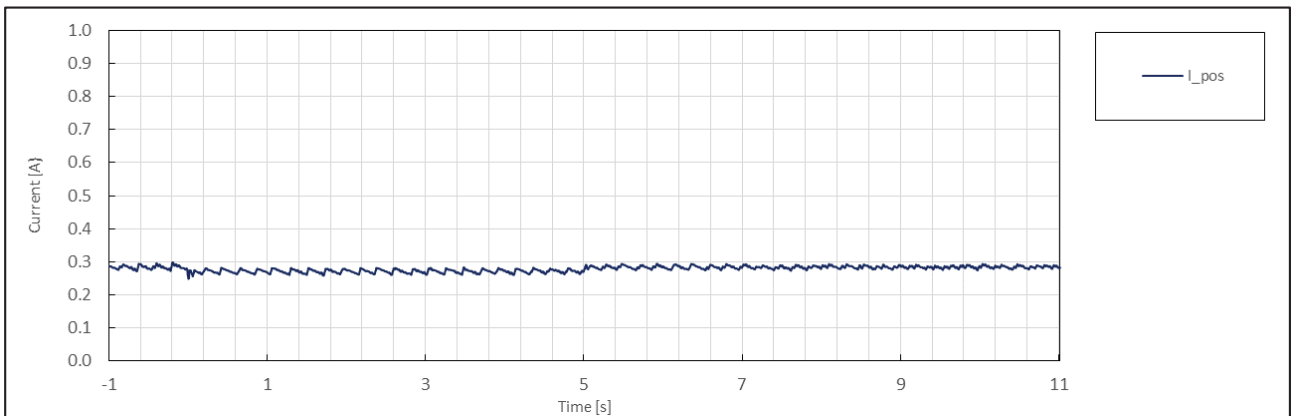
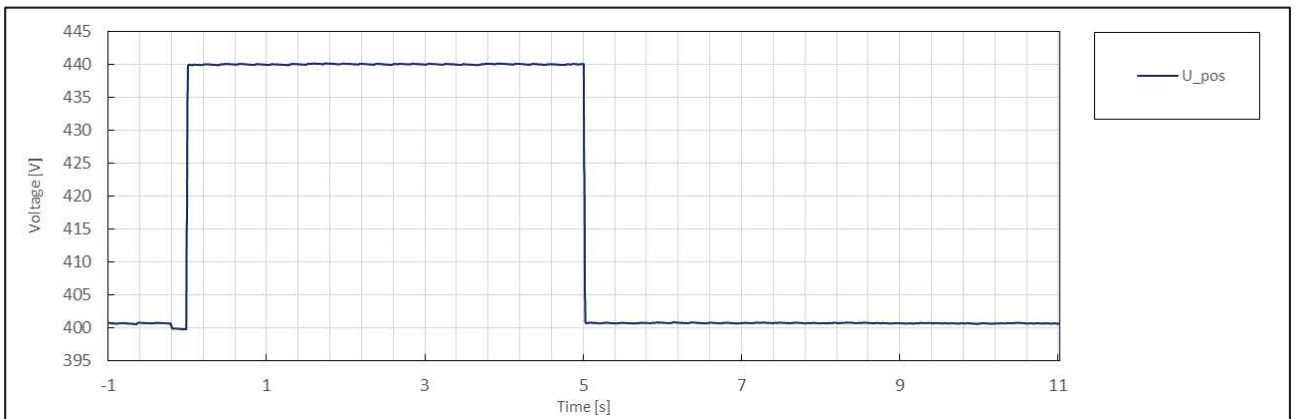
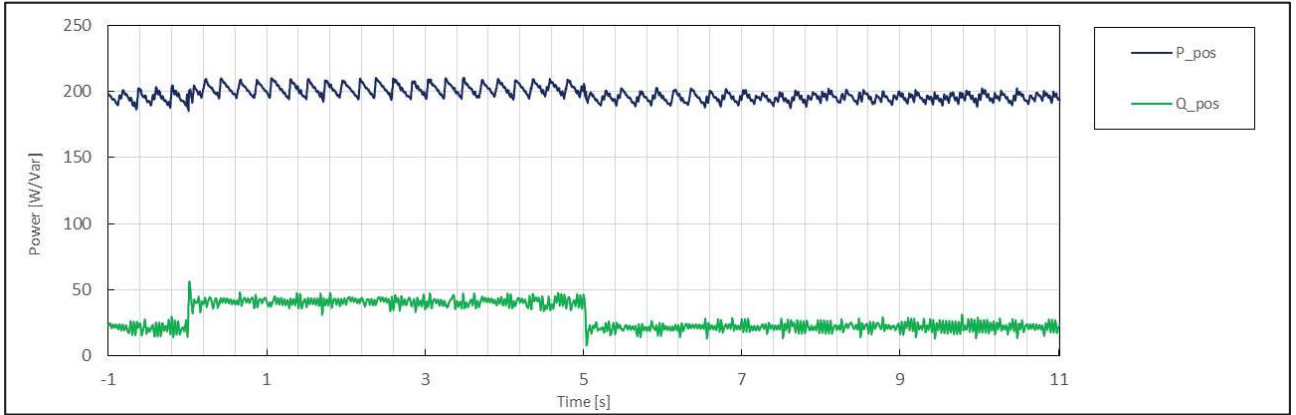

|                     | No. | Parameter  | Phase ref.      | Time ref.                       | unit       | Result        |
|---------------------|-----|--|-----------------|---------------------------------|------------|---------------|
| General Info.       | 0   | Test number  | --              | --                              | --         | 7.1           |
|                     | 1   | Date   | --              | --                              | dd.mm.yyyy | 3.1.2020      |
|                     | 2   | Time (start of test)                                   | --              | --                              | hh:mm:ss.f | 15:19:46      |
|                     | 3   | Fault type (phase)                                     | --              | --                              |            | 3-phase fault |
|                     | 4   | Setting voltage depth                                  | Line to line    | --                              | p.u.       | 1.15          |
|                     | 5   | Setting dip duration                                   |                 | --                              |            | 60019         |
|                     | 6   | Point of fault entry                                   | Total           | --                              | ms         | 0             |
|                     | 7   | Point of fault clearance                               | Total           | --                              | ms         | 60018         |
|                     | 8   | Fault duration in empty load test                      | Total           | --                              | ms         | 60019         |
|                     | 9   | Voltage depth/height in empty load test                | Total           | t1+100ms to t2 and t1-10s to t1 | p.u.       | 1.15          |
|                     | 10  |  | Pos.            |                                 | p.u.       | 1.15          |
| Before dip <t1      | 11  | Voltage  | Line to neutral | t1-100s to t1                   | p.u.       | 1.02          |
|                     | 12  | Current  | Pos.            | t1-500ms to t1-100ms            | p.u.       | 0.32          |
|                     | 13  | Active power   | Total           | t1-10s to t1                    | p.u.       | 1.00          |
|                     | 14  |  | Pos.            |                                 |            | 0.98          |
|                     | 15  | Reactive power   | Total           | t1-10s to t1                    | p.u.       | 0.05          |
|                     | 16  |  | Pos.            |                                 |            | 0.04          |
|                     | 17  | Cos $\varphi$  | --              | t1-10s to t1                    | --         | 0.998         |
| During dip t1 to t2 | 18  | Voltage  | Line to neutral | t1+100ms to t2-20ms             | p.u.       | 1.15          |
|                     | 19  | Line current   | Phase 1         | t1+60ms                         | p.u.       | N/A           |
|                     | 20  |  | Phase 2         |                                 |            | N/A           |
|                     | 21  |  | Phase 3         |                                 |            | 0.03          |
|                     | 22  | Line current   | Phase 1         | t1+100ms                        | p.u.       | N/A           |
|                     | 23  |  | Phase 2         |                                 |            | N/A           |
|                     | 24  |  | Phase 3         |                                 |            | 0.03          |
|                     | 25  | Active power   | Total           | t1+100ms to t2-20ms             | p.u.       | 0.00          |
|                     | 26  |  | Pos.            |                                 |            | 0.00          |
| After dip > t2      | 27  | Voltage  | Line to neutral | t2+3s to t2+10s                 | p.u.       | 1.02          |
|                     | 28  | Active power   | Total           | t2+3s to t2+10s                 | p.u.       | 1.01          |
|                     | 29  |  | Pos.            |                                 |            | 0.98          |
|                     | 39  | Active power rising time                               | Pos.            | --                              | s          | 0.578         |
|                     | 31  | Reactive power   | Total           | t2+3s to t2+10s                 | p.u.       | 0.05          |
|                     | 32  |  | Pos.            |                                 |            | 0.05          |
|                     | 33  | Reactive power rising time                             | Pos.            | --                              | s          | N/A           |
|                     | 34  | PGU does not disconnect from grid till 60s after fault | --              | t2 to t2+60s                    | Yes / No   | No            |

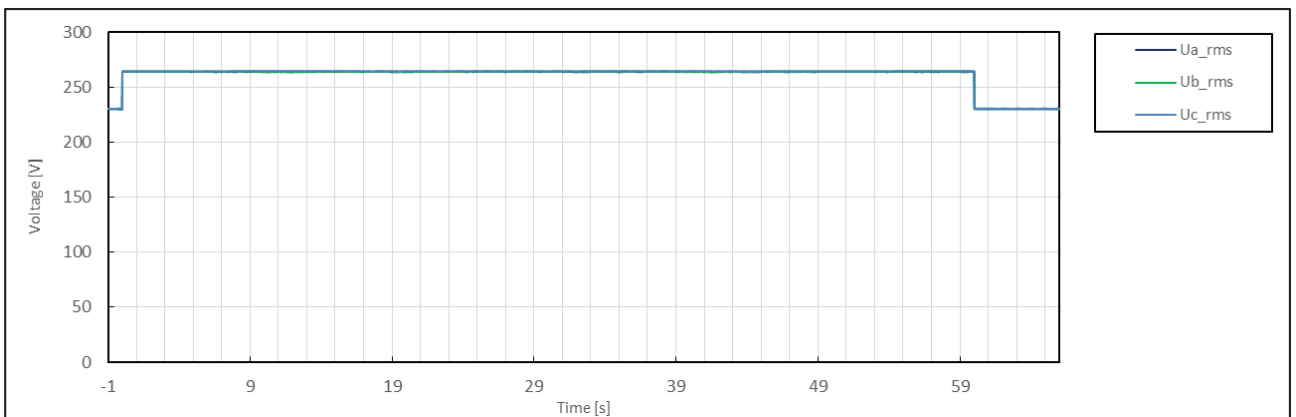
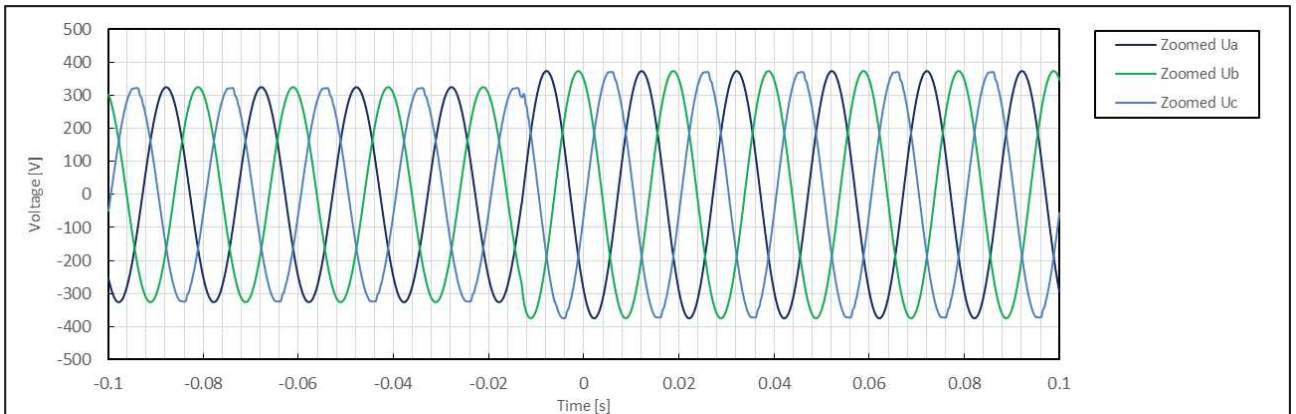
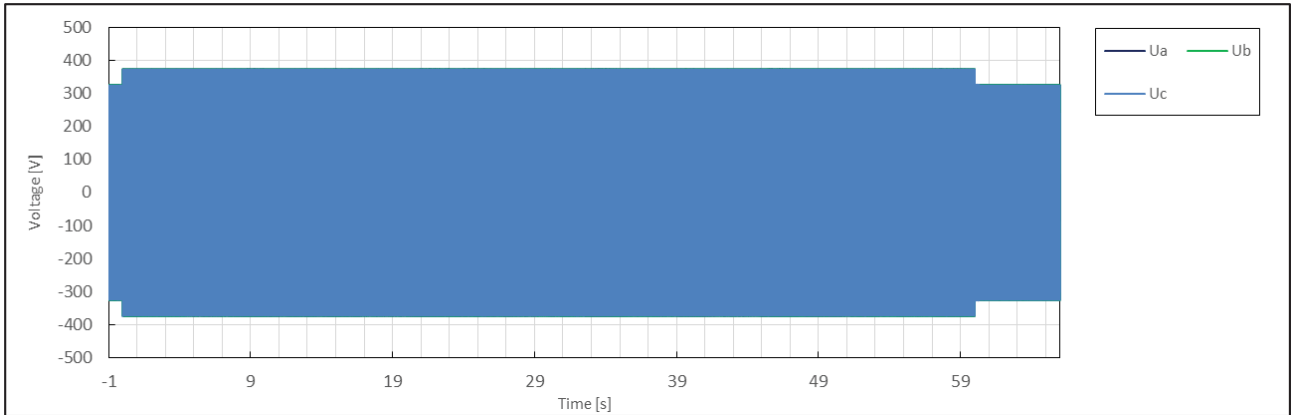

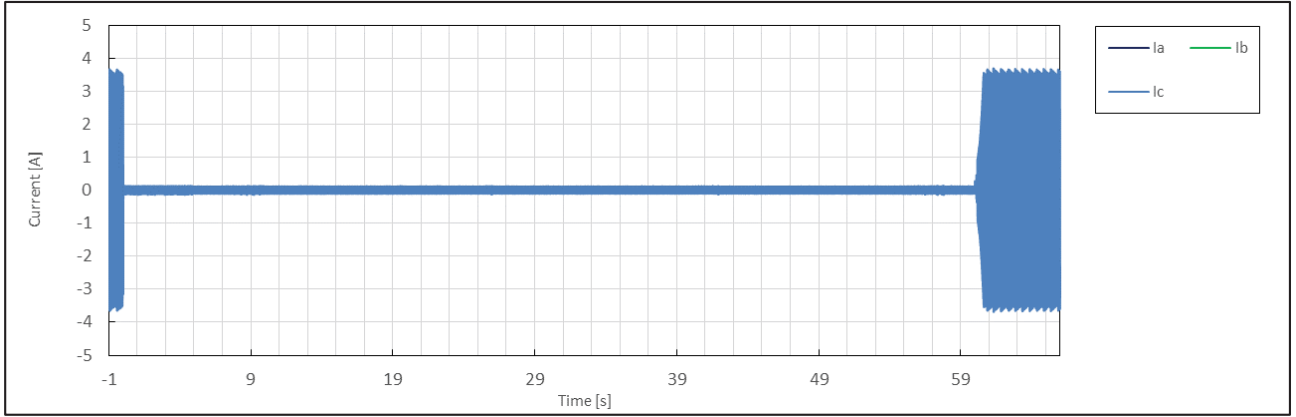
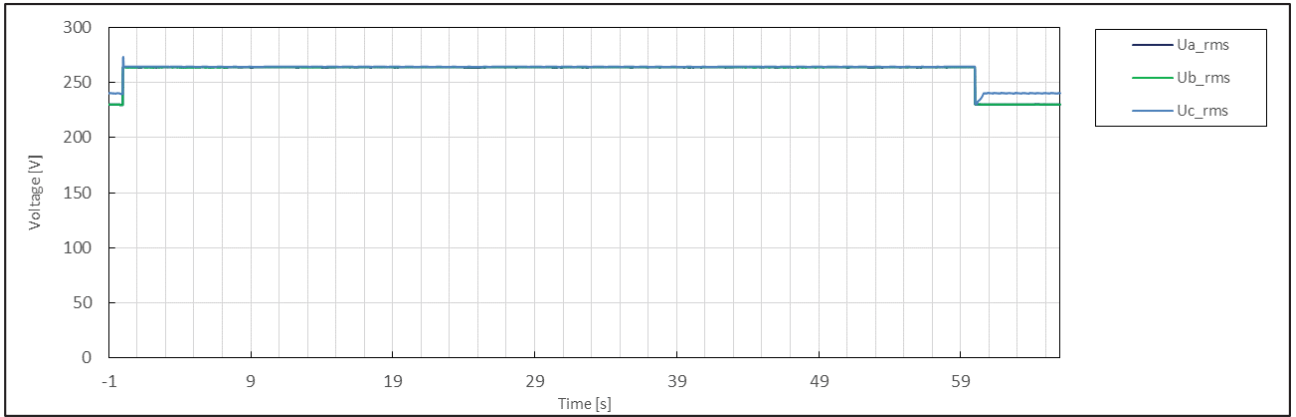
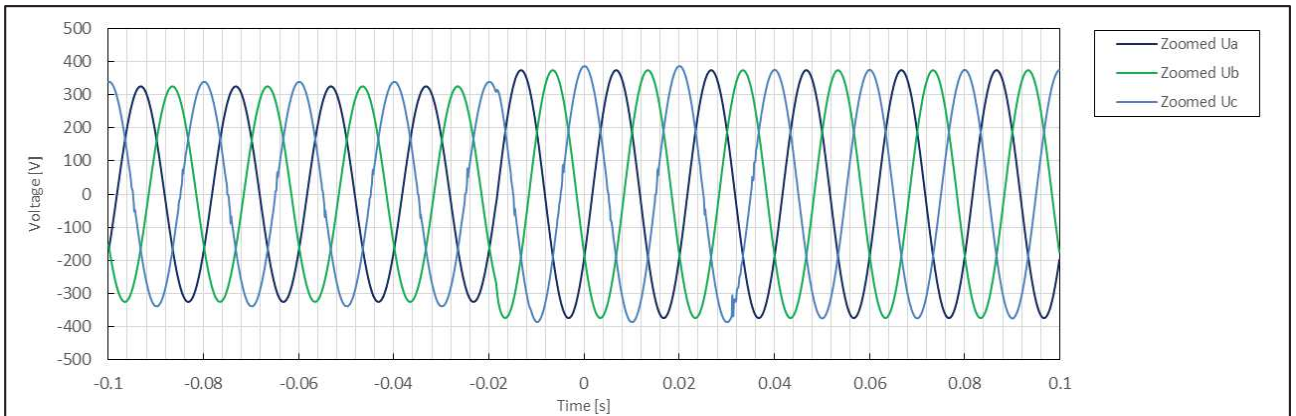
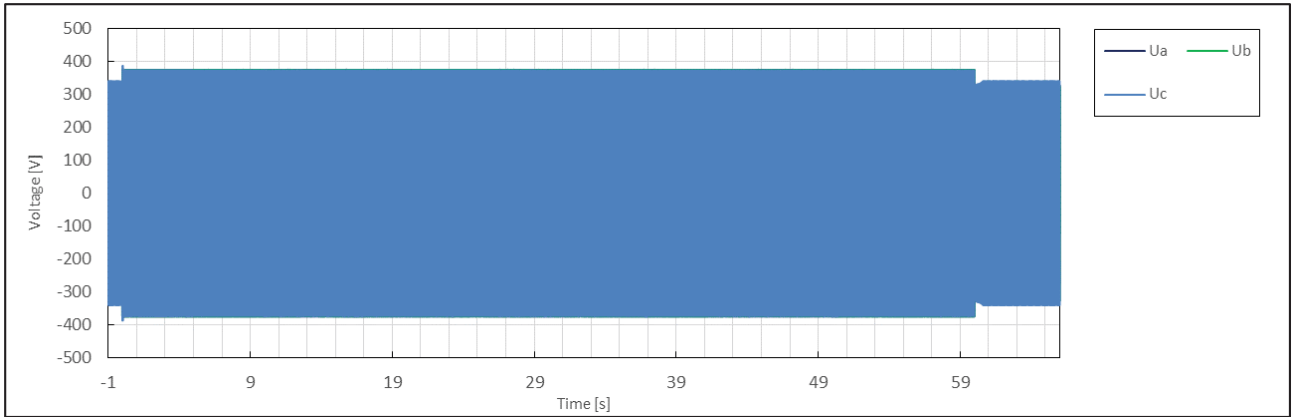

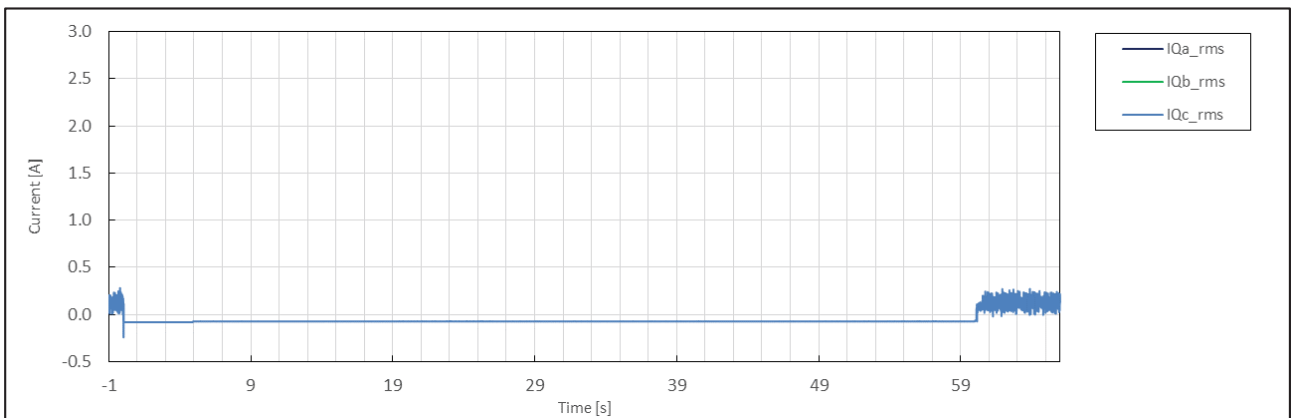
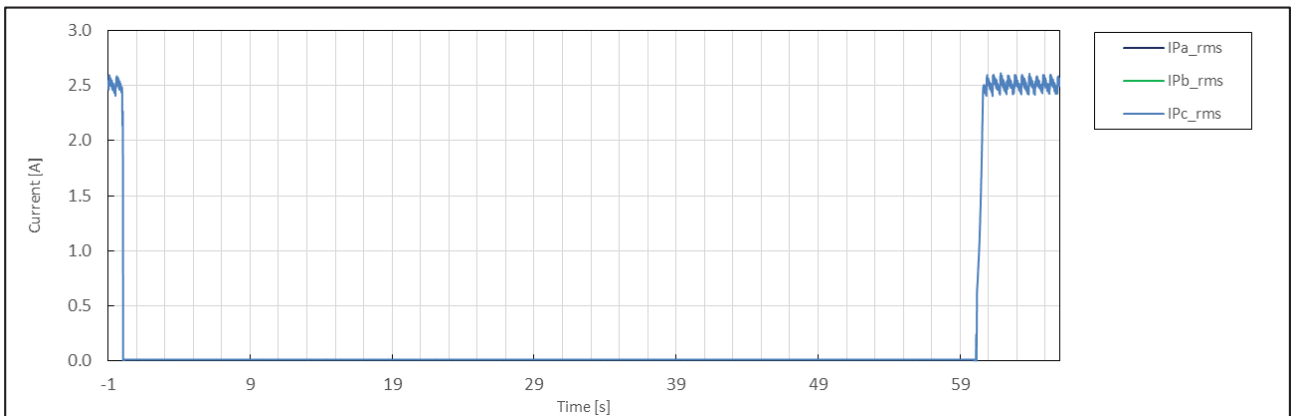
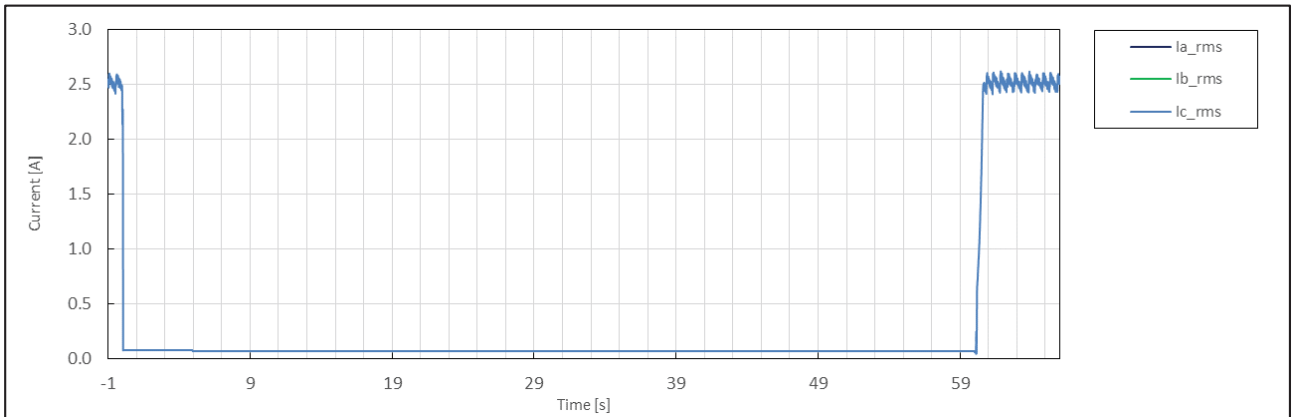
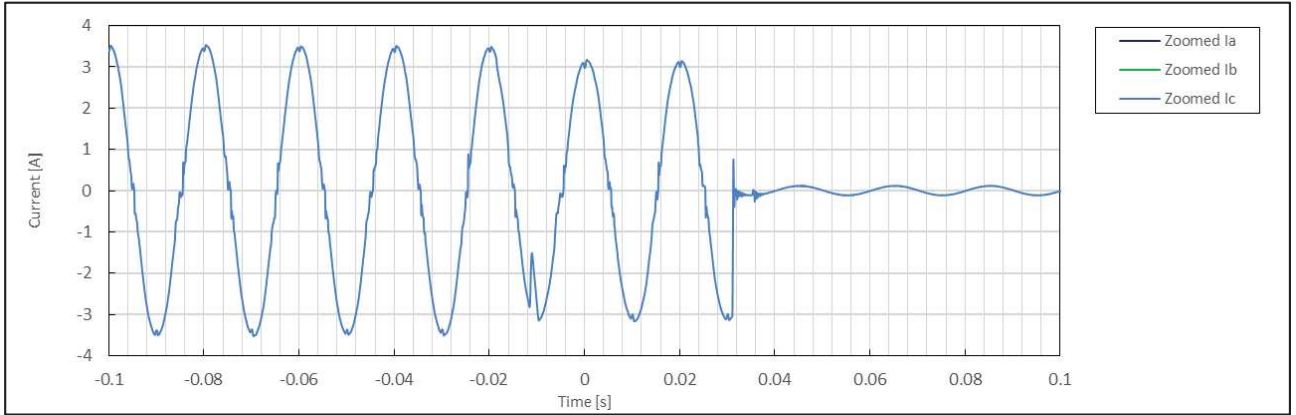



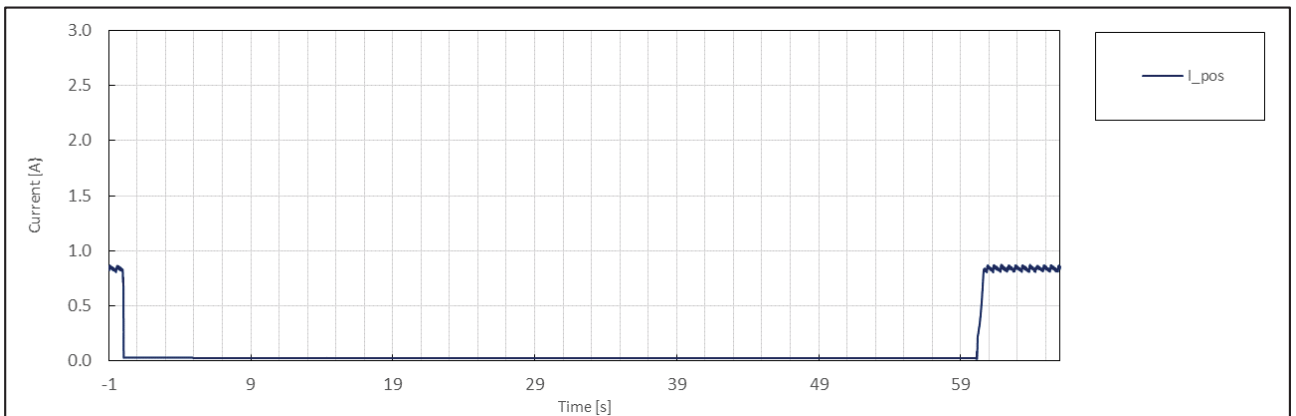
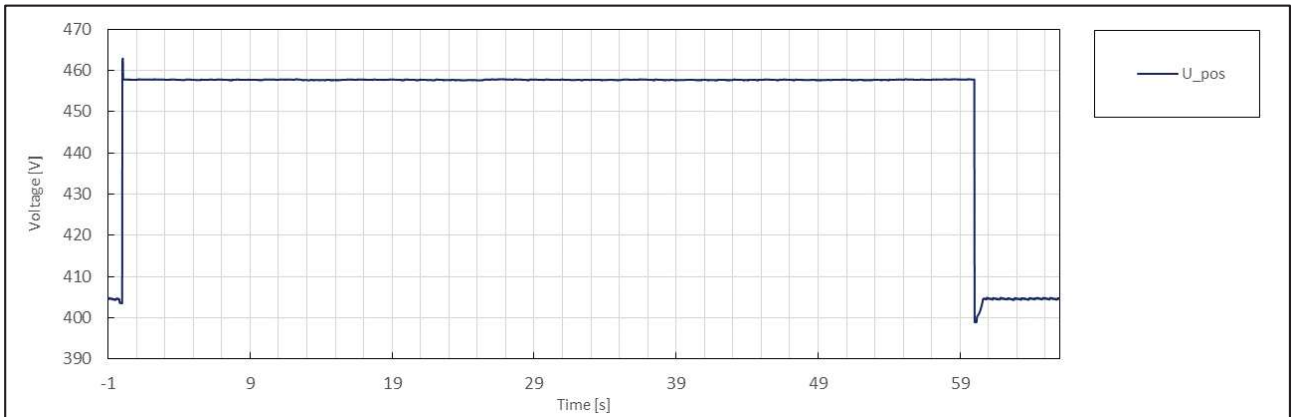
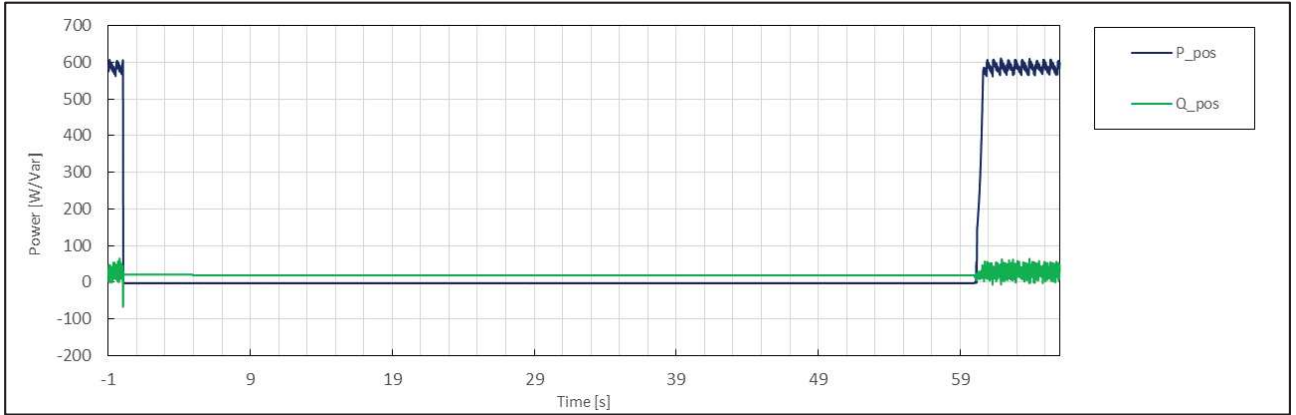

|                     | No. | Parameter  | Phase ref.      | Time ref.                       | unit       | Result        |
|---------------------|-----|--|-----------------|---------------------------------|------------|---------------|
| General Info.       | 0   | Test number  | --              | --                              | --         | 7.2           |
|                     | 1   | Date   | --              | --                              | dd.mm.yyyy | 3.1.2020      |
|                     | 2   | Time (start of test)                                   | --              | --                              | hh:mm:ss.f | 15:25:12      |
|                     | 3   | Fault type (phase)                                     | --              | --                              |            | 3-phase fault |
|                     | 4   | Setting voltage depth                                  | Line to line    | --                              | p.u.       | 1.15          |
|                     | 5   | Setting dip duration                                   |                 | --                              |            | 60019         |
|                     | 6   | Point of fault entry                                   | Total           | --                              | ms         | 0             |
|                     | 7   | Point of fault clearance                               | Total           | --                              | ms         | 60018         |
|                     | 8   | Fault duration in empty load test                      | Total           | --                              | ms         | 60019         |
|                     | 9   | Voltage depth/height in empty load test                | Total           | t1+100ms to t2 and t1-10s to t1 | p.u.       | 1.15          |
|                     | 10  |  | Pos.            |                                 | p.u.       | 1.15          |
| Before dip <t1      | 11  | Voltage  | Line to neutral | t1-100s to t1                   | p.u.       | 1.01          |
|                     | 12  | Current  | Pos.            | t1-500ms to t1-100ms            | p.u.       | 0.11          |
|                     | 13  | Active power   | Total           | t1-10s to t1                    | p.u.       | 0.33          |
|                     | 14  |  | Pos.            |                                 |            | 0.32          |
|                     | 15  | Reactive power   | Total           | t1-10s to t1                    | p.u.       | 0.04          |
|                     | 16  |  | Pos.            |                                 |            | 0.04          |
|                     | 17  | Cos $\varphi$  | --              | t1-10s to t1                    | --         | 0.994         |
| During dip t1 to t2 | 18  | Voltage  | Line to neutral | t1+100ms to t2-20ms             | p.u.       | 1.15          |
|                     | 19  | Line current   | Phase 1         | t1+60ms                         | p.u.       | N/A           |
|                     | 20  |  | Phase 2         |                                 |            | N/A           |
|                     | 21  |  | Phase 3         |                                 |            | 0.18          |
|                     | 22  | Line current   | Phase 1         | t1+100ms                        | p.u.       | N/A           |
|                     | 23  |  | Phase 2         |                                 |            | N/A           |
|                     | 24  |  | Phase 3         |                                 |            | 0.03          |
|                     | 25  | Active power   | Total           | t1+100ms to t2-20ms             | p.u.       | 0.00          |
|                     | 26  |  | Pos.            |                                 |            | 0.00          |
| After dip > t2      | 27  | Voltage  | Line to neutral | t2+3s to t2+10s                 | p.u.       | 1.01          |
|                     | 28  | Active power   | Total           | t2+3s to t2+10s                 | p.u.       | 0.33          |
|                     | 29  |  | Pos.            |                                 |            | 0.33          |
|                     | 39  | Active power rising time                               | Pos.            | --                              | s          | 0.935         |
|                     | 31  | Reactive power   | Total           | t2+3s to t2+10s                 | p.u.       | 0.04          |
|                     | 32  |  | Pos.            |                                 |            | 0.04          |
|                     | 33  | Reactive power rising time                             | Pos.            | --                              | s          | N/A           |
|                     | 34  | PGU does not disconnect from grid till 60s after fault | --              | t2 to t2+60s                    | Yes / No   | No            |

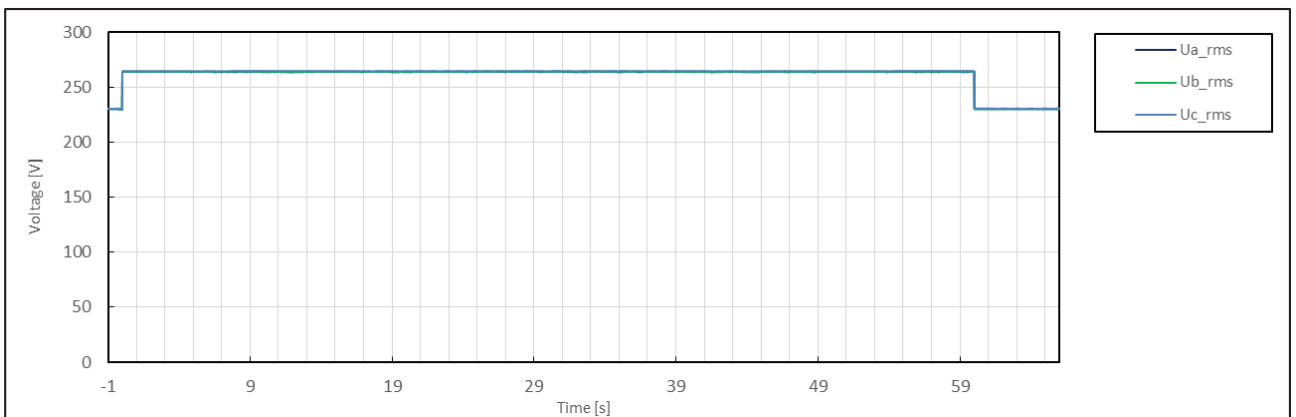
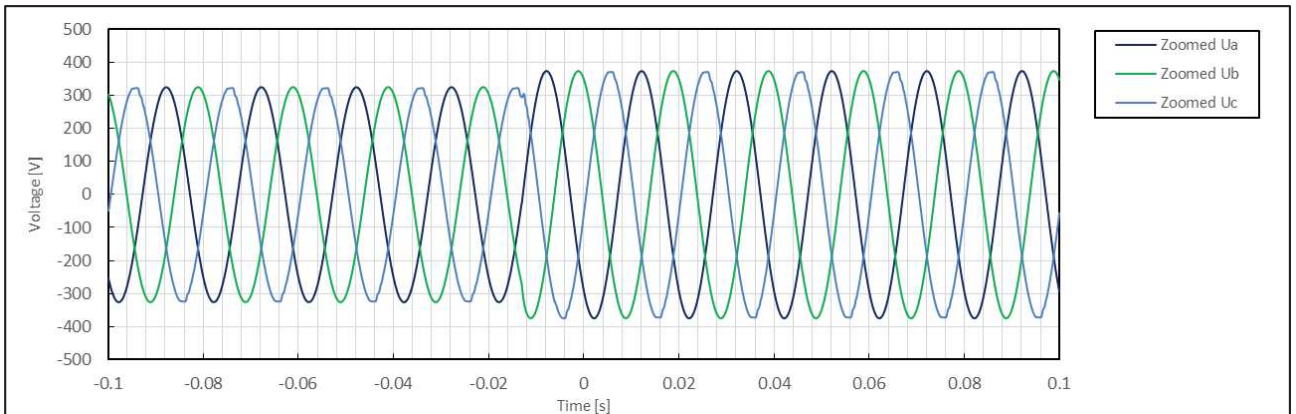
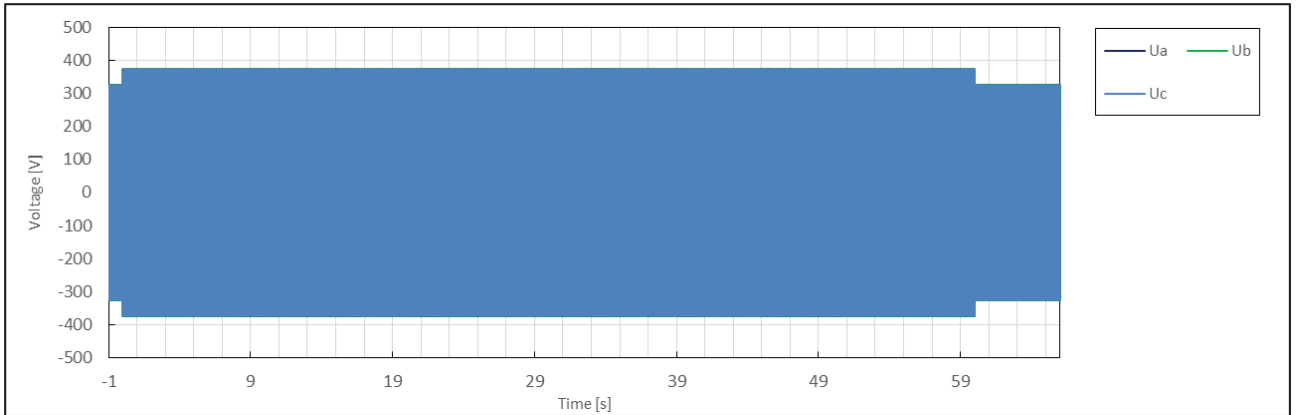

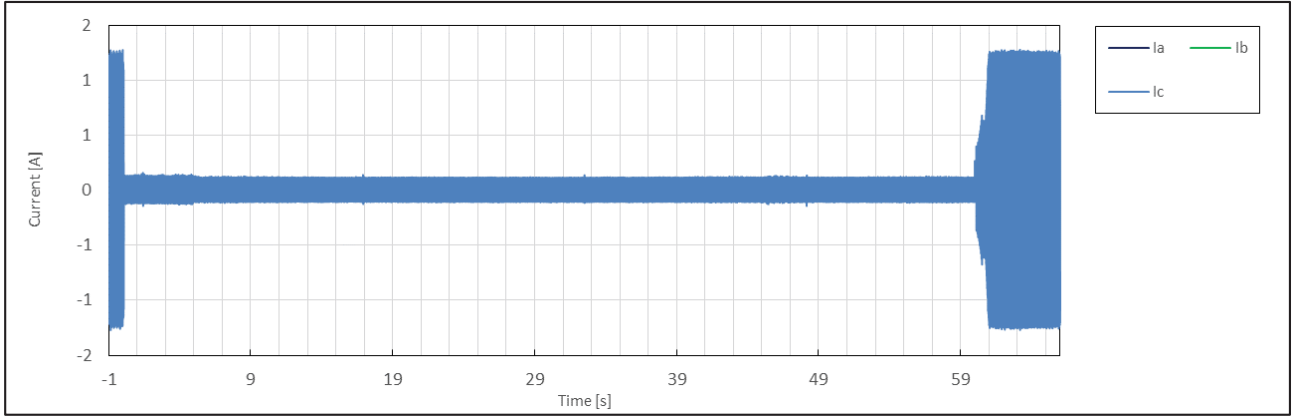
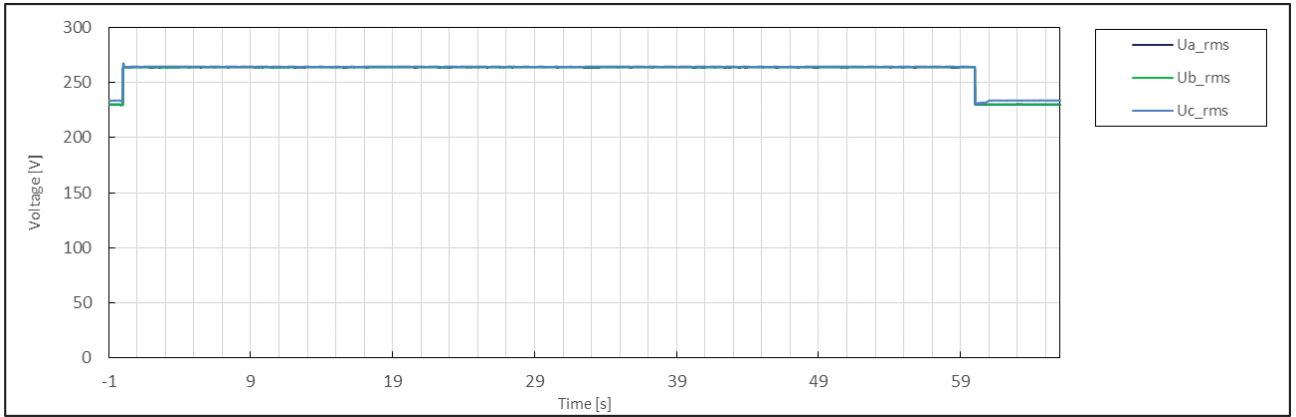
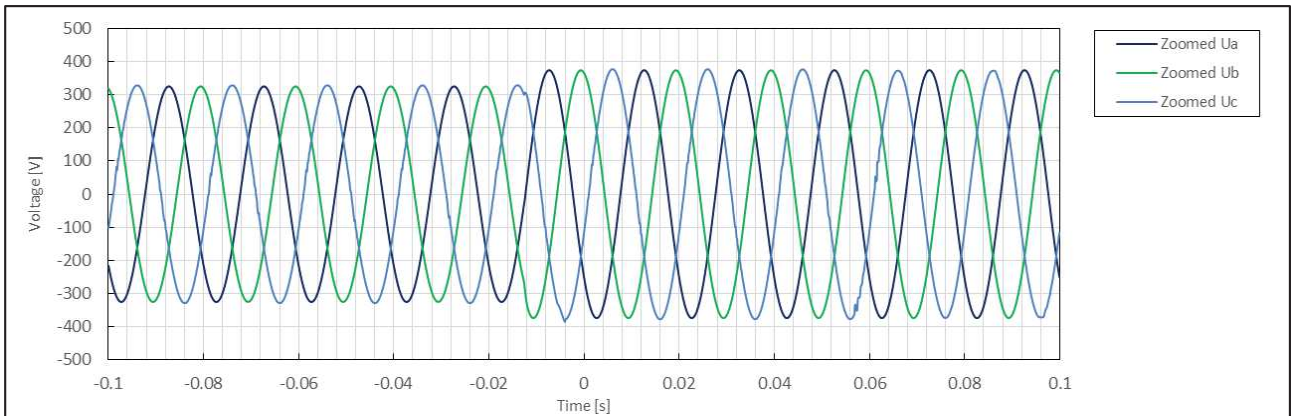
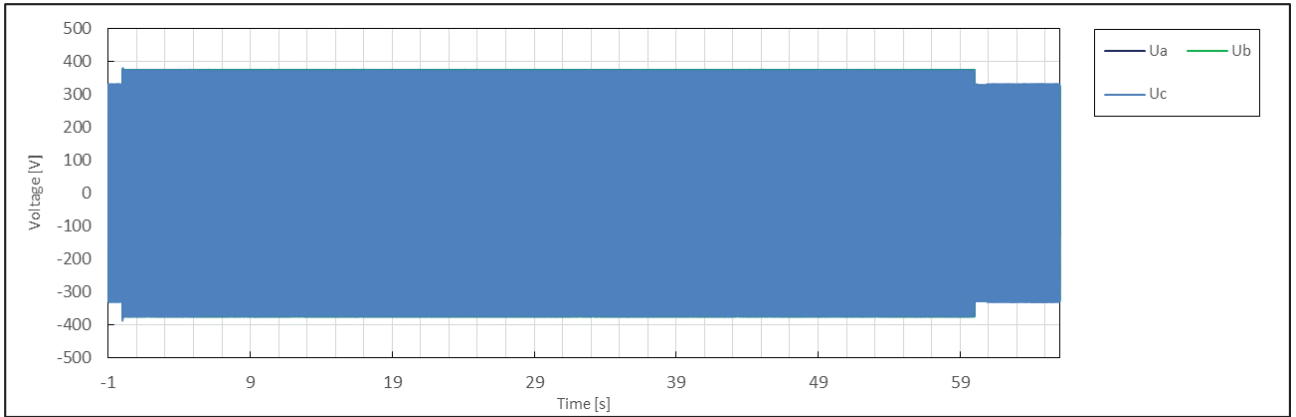

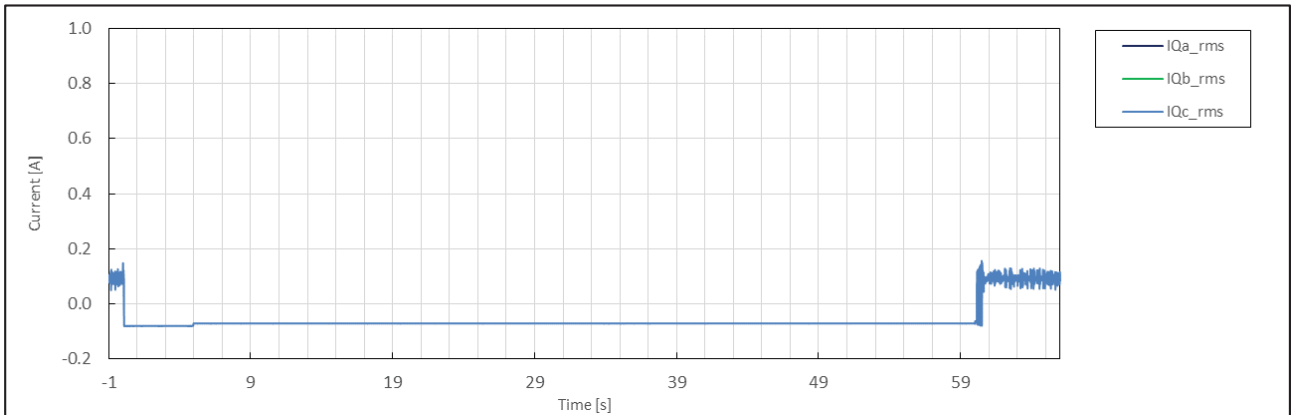
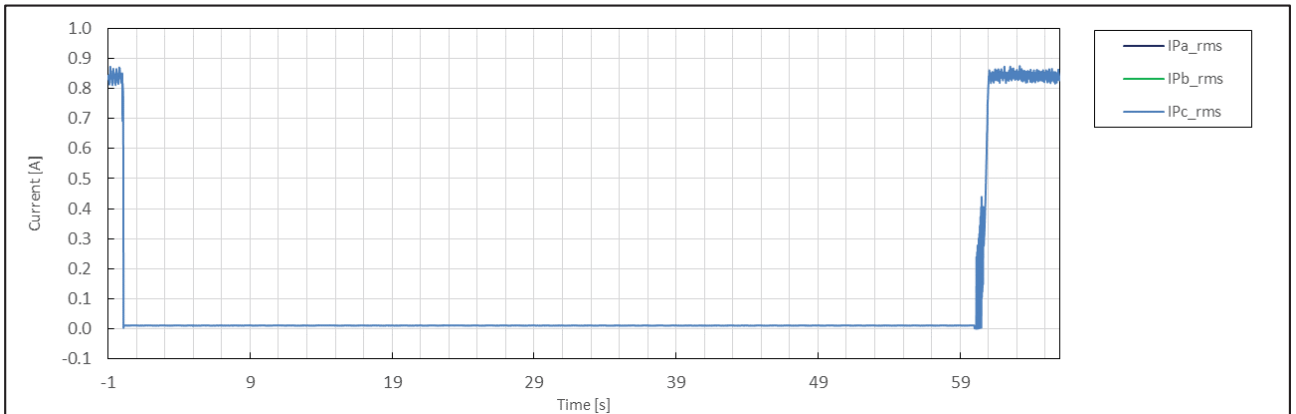
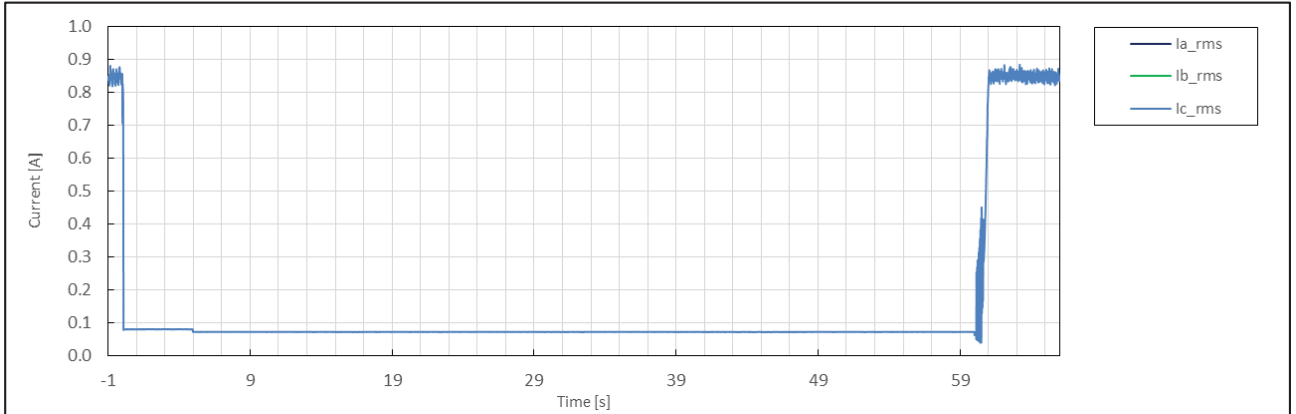
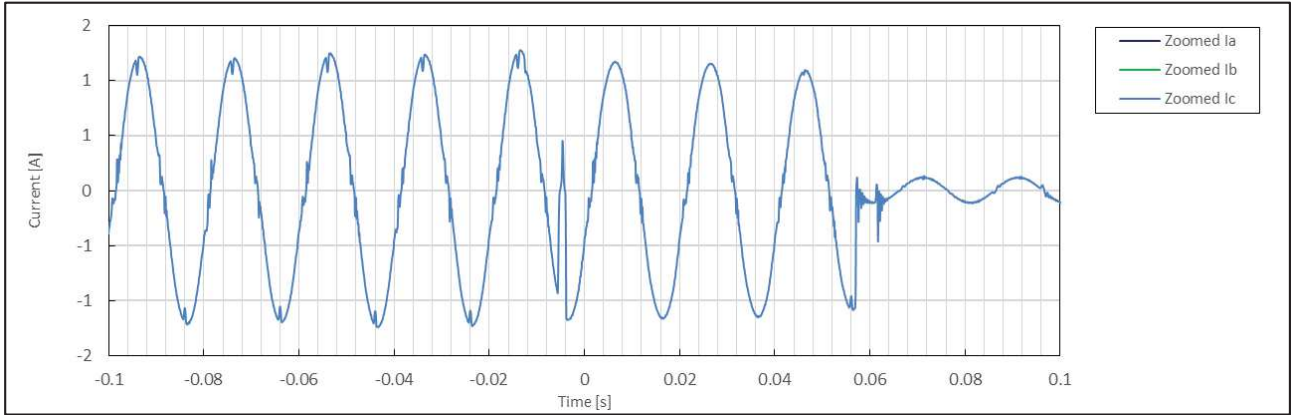

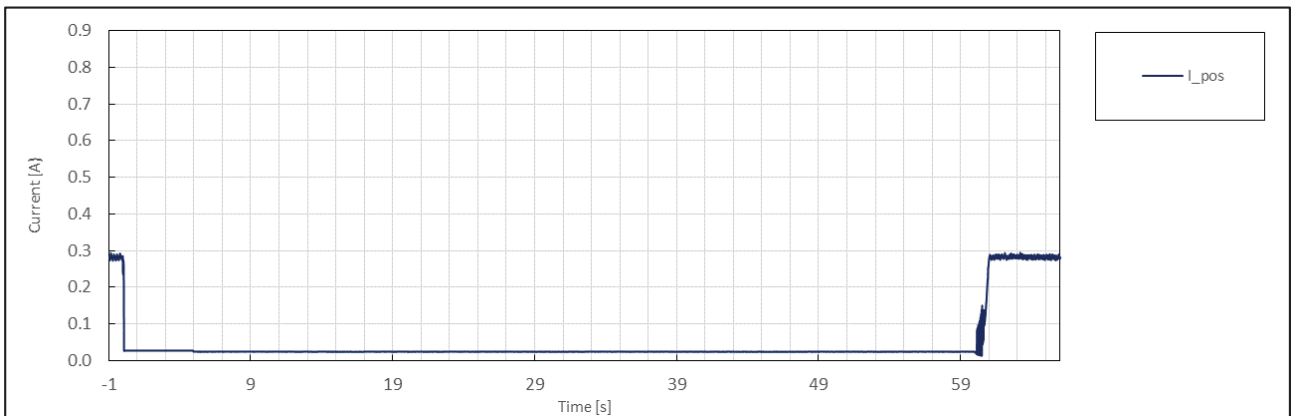
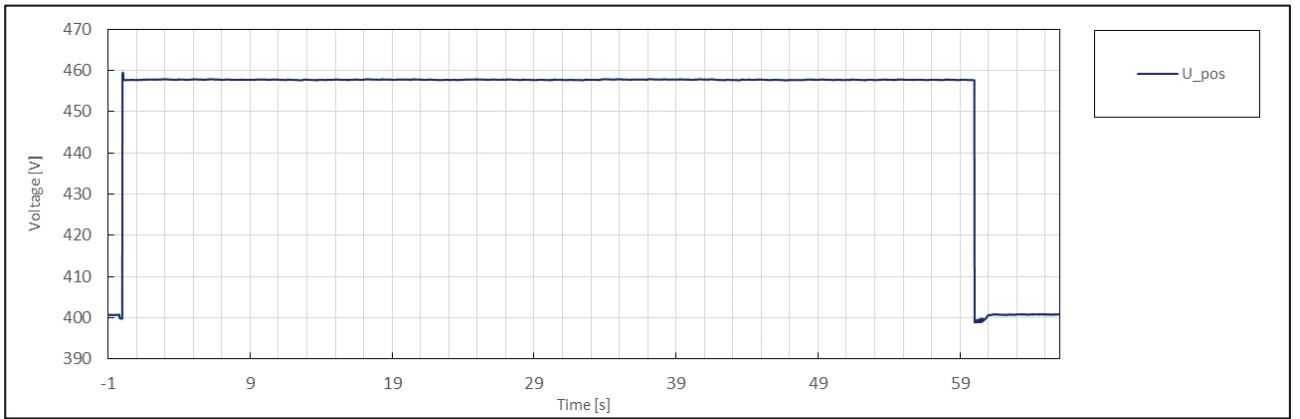
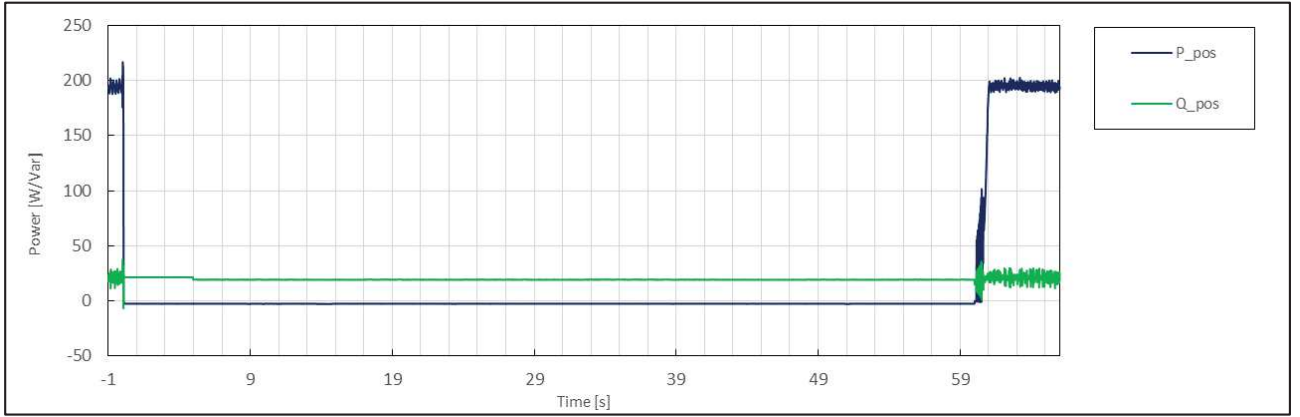

|                     | No. | Parameter  | Phase ref.      | Time ref.                       | unit       | Result        |
|---------------------|-----|--|-----------------|---------------------------------|------------|---------------|
| General Info.       | 0   | Test number  | --              | --                              | --         | 7.3           |
|                     | 1   | Date   | --              | --                              | dd.mm.yyyy | 3.1.2020      |
|                     | 2   | Time (start of test)                                   | --              | --                              | hh:mm:ss.f | 15:29:40      |
|                     | 3   | Fault type (phase)                                     | --              | --                              |            | 2-phase fault |
|                     | 4   | Setting voltage depth                                  | Line to line    | --                              | p.u.       | 1.15          |
|                     | 5   | Setting dip duration                                   |                 | --                              |            | 60019         |
|                     | 6   | Point of fault entry                                   | Total           | --                              | ms         | 0             |
|                     | 7   | Point of fault clearance                               | Total           | --                              | ms         | 60018         |
|                     | 8   | Fault duration in empty load test                      | Total           | --                              | ms         | 60019         |
|                     | 9   | Voltage depth/height in empty load test                | Total           | t1+100ms to t2 and t1-10s to t1 | p.u.       | 1.04          |
|                     | 10  |  | Pos.            |                                 | p.u.       | 1.07          |
| Before dip <t1      | 11  | Voltage  | Line to neutral | t1-100s to t1                   | p.u.       | 1.02          |
|                     | 12  | Current  | Pos.            | t1-500ms to t1-100ms            | p.u.       | 0.32          |
|                     | 13  | Active power   | Total           | t1-10s to t1                    | p.u.       | 1.00          |
|                     | 14  |  | Pos.            |                                 |            | 0.97          |
|                     | 15  | Reactive power   | Total           | t1-10s to t1                    | p.u.       | 0.05          |
|                     | 16  |  | Pos.            |                                 |            | 0.05          |
|                     | 17  | Cos $\varphi$  | --              | t1-10s to t1                    | --         | 0.998         |
| During dip t1 to t2 | 18  | Voltage  | Line to neutral | t1+100ms to t2-20ms             | p.u.       | 1.08          |
|                     | 19  | Line current   | Phase 1         | t1+60ms                         | p.u.       | N/A           |
|                     | 20  |  | Phase 2         |                                 |            | N/A           |
|                     | 21  |  | Phase 3         |                                 |            | 0.96          |
|                     | 22  | Line current   | Phase 1         | t1+100ms                        | p.u.       | N/A           |
|                     | 23  |  | Phase 2         |                                 |            | N/A           |
|                     | 24  |  | Phase 3         |                                 |            | 0.94          |
|                     | 25  | Active power   | Total           | t1+100ms to t2-20ms             | p.u.       | 1.00          |
|                     | 26  |  | Pos.            |                                 |            | 1.01          |
| After dip > t2      | 27  | Voltage  | Line to neutral | t2+3s to t2+10s                 | p.u.       | 1.02          |
|                     | 28  | Active power   | Total           | t2+3s to t2+10s                 | p.u.       | 1.00          |
|                     | 29  |  | Pos.            |                                 |            | 0.98          |
|                     | 39  | Active power rising time                               | Pos.            | --                              | s          | N/A           |
|                     | 31  | Reactive power   | Total           | t2+3s to t2+10s                 | p.u.       | 0.05          |
|                     | 32  |  | Pos.            |                                 |            | 0.05          |
|                     | 33  | Reactive power rising time                             | Pos.            | --                              | s          | N/A           |
|                     | 34  | PGU does not disconnect from grid till 60s after fault | --              | t2 to t2+60s                    | Yes / No   | No            |

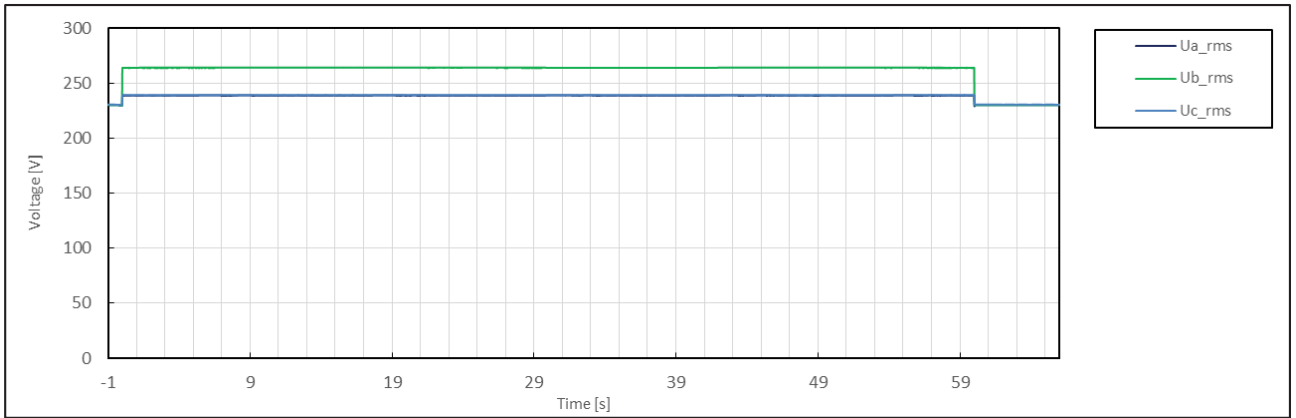
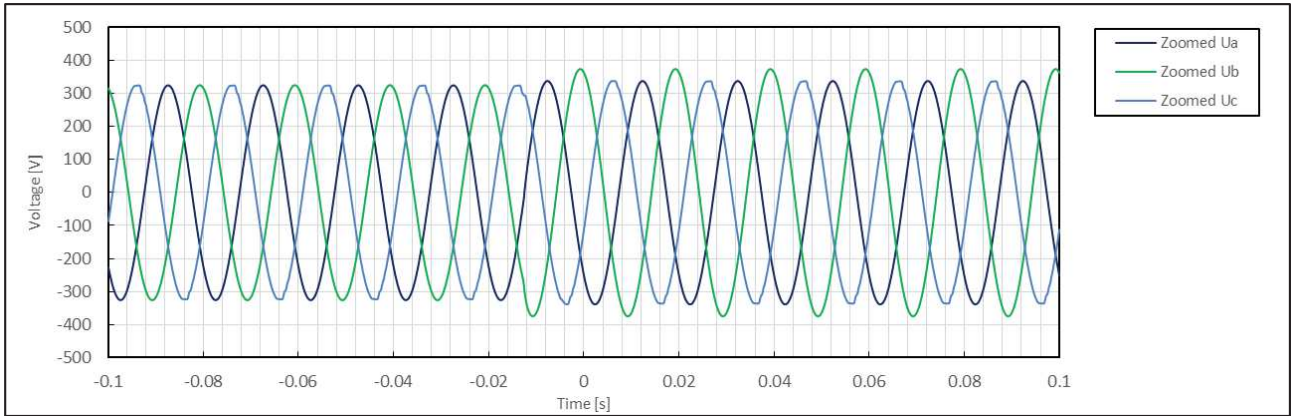
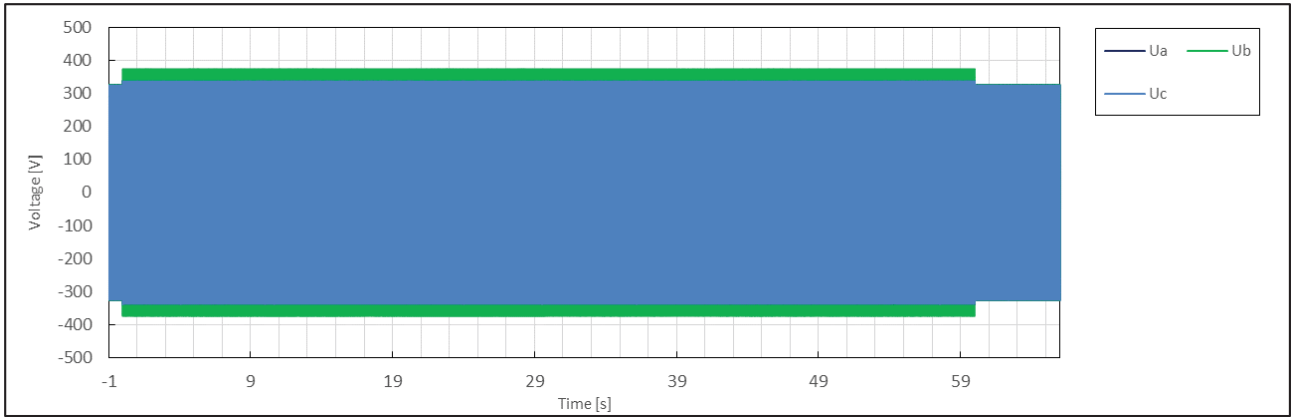



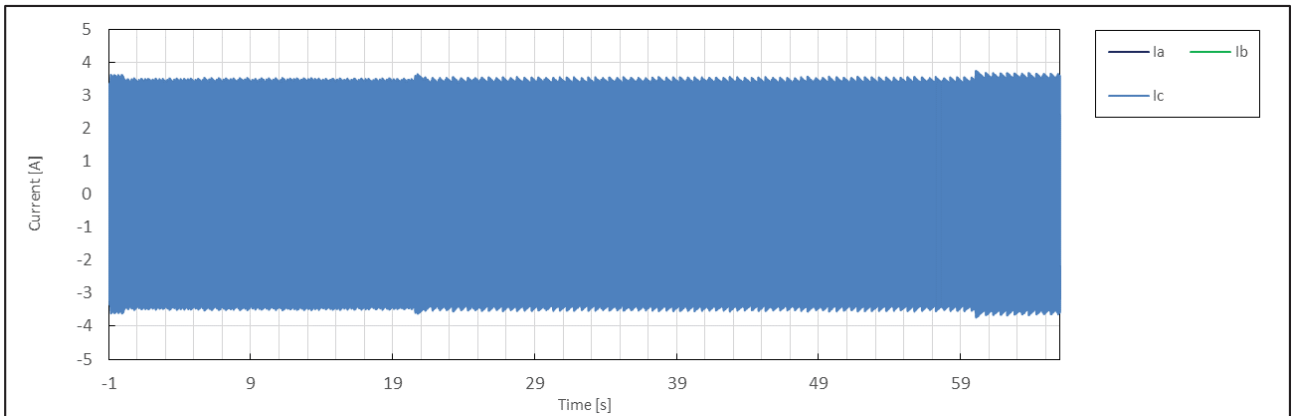
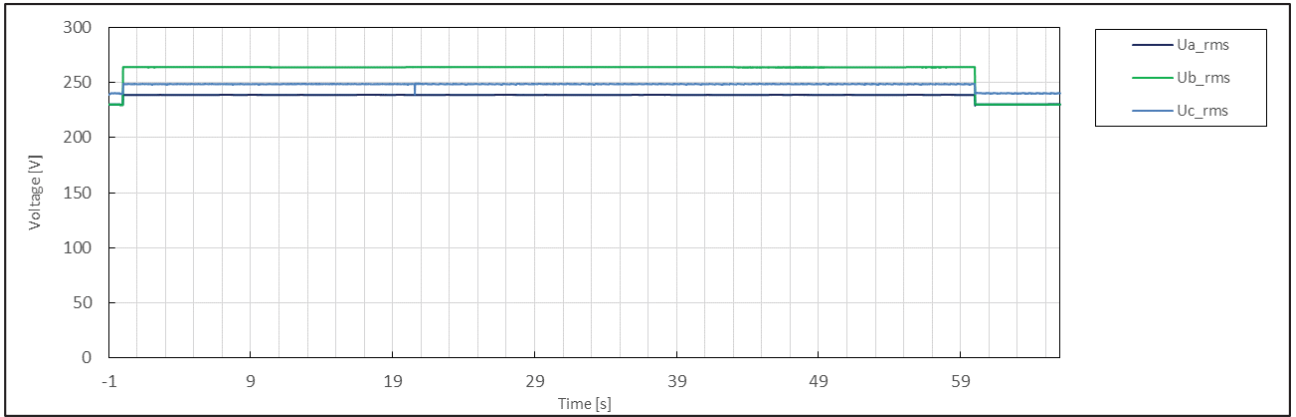
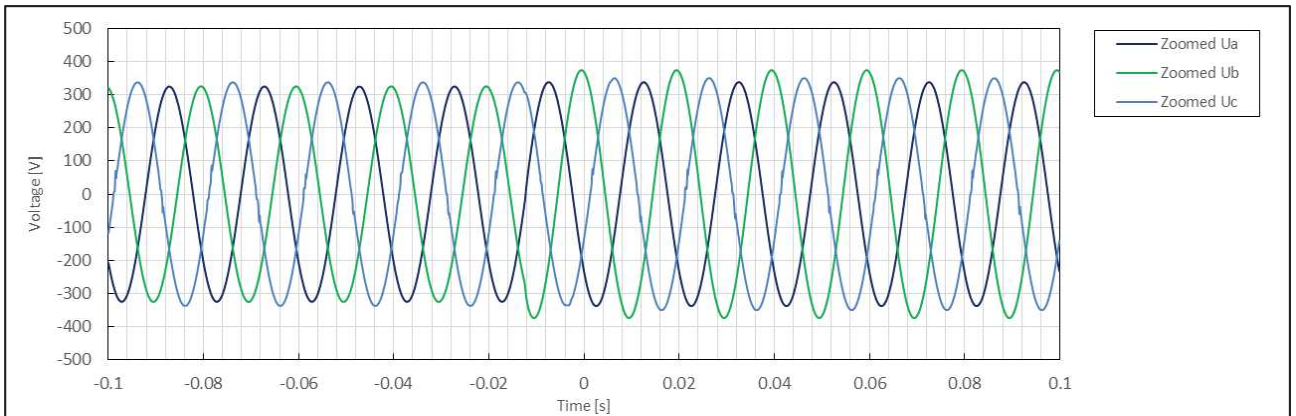
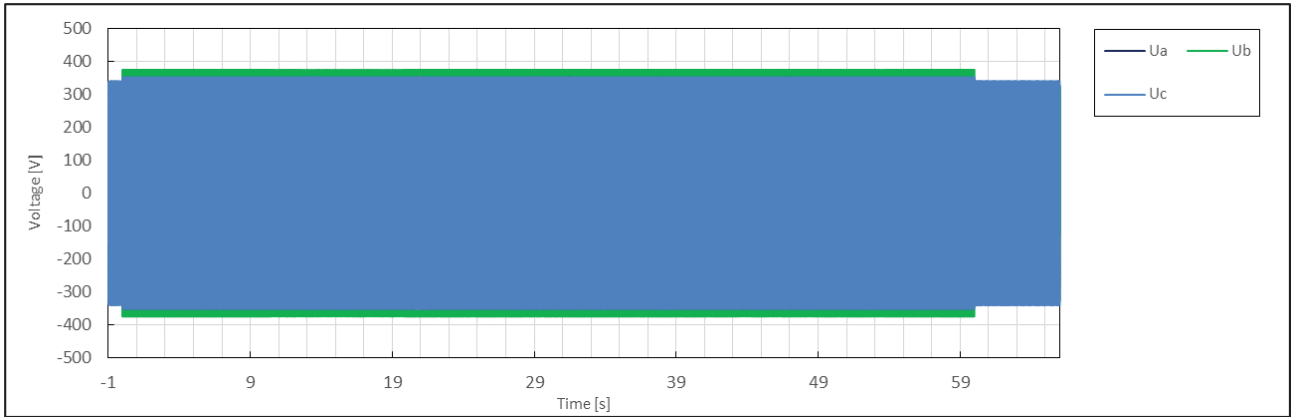

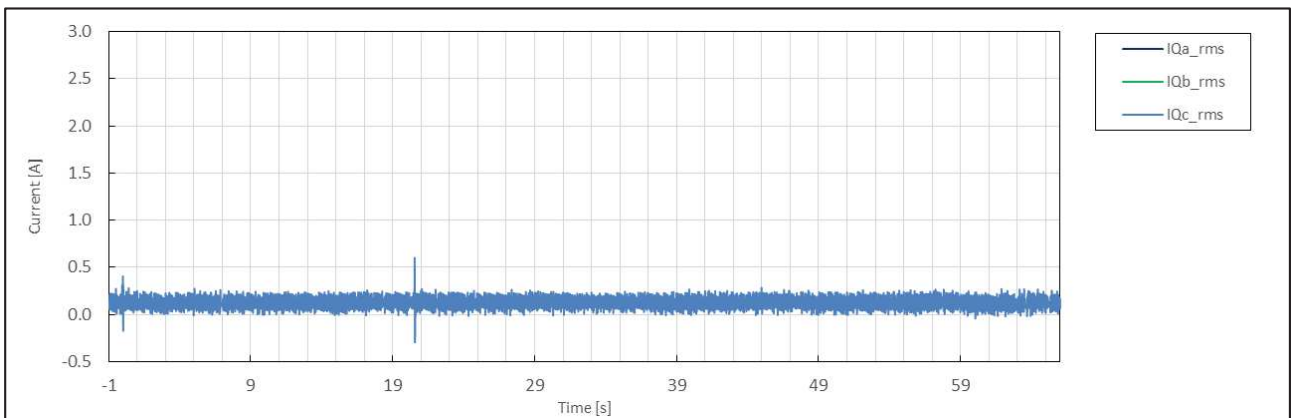
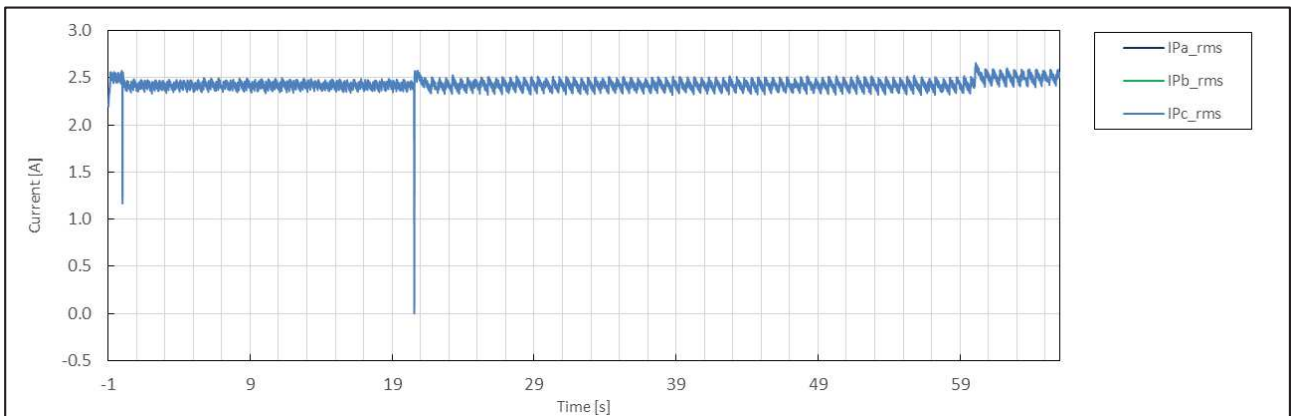
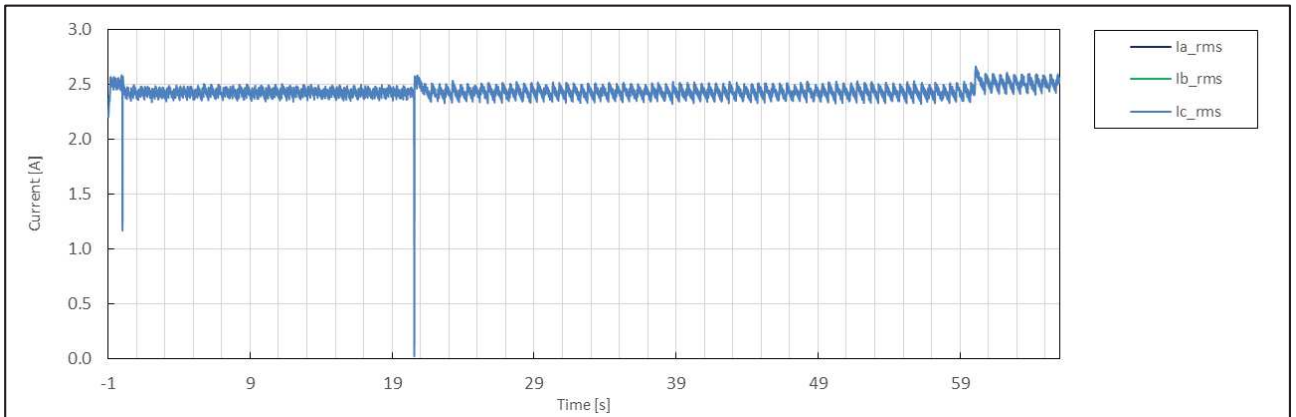
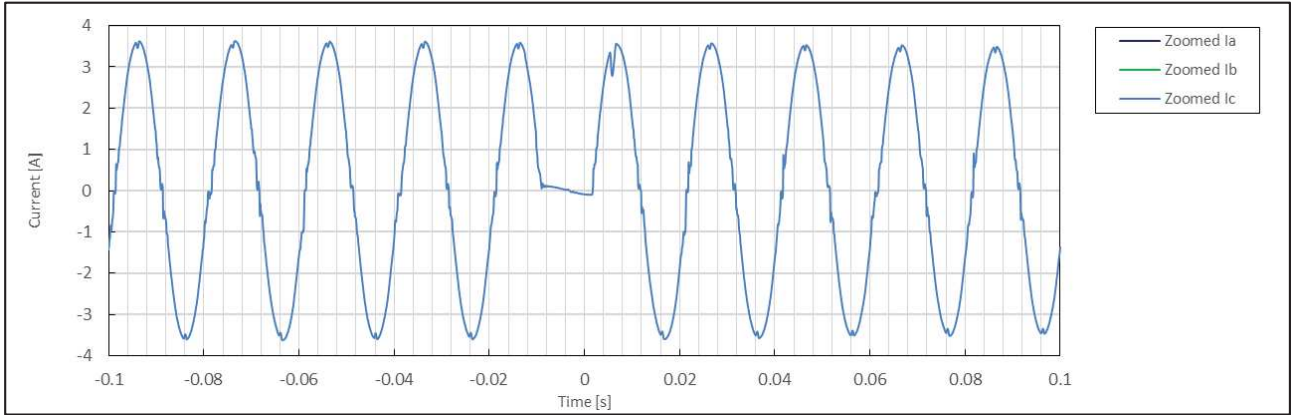

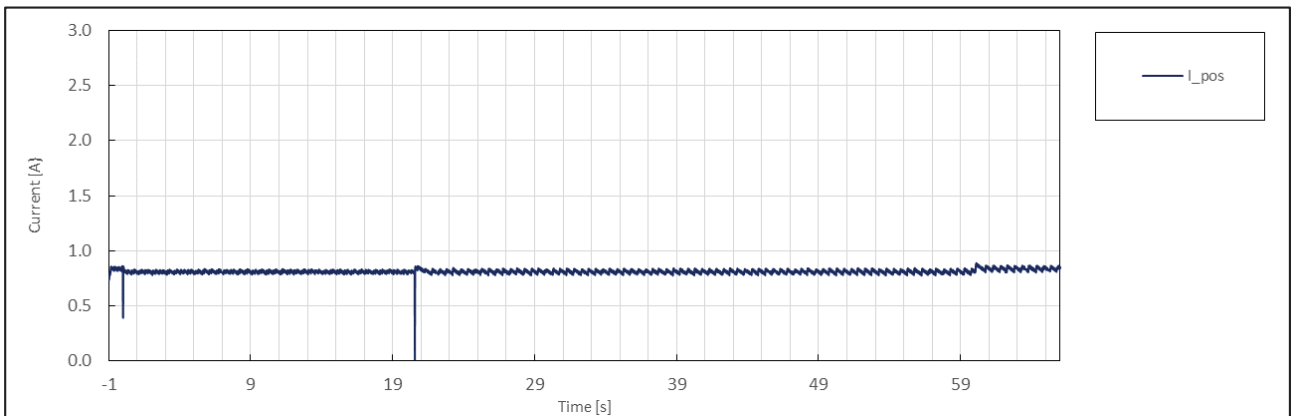
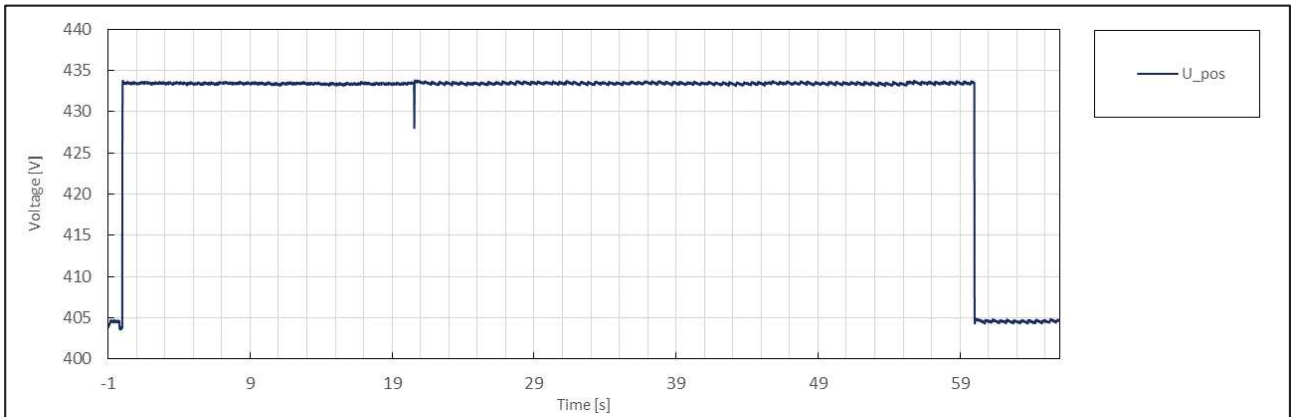
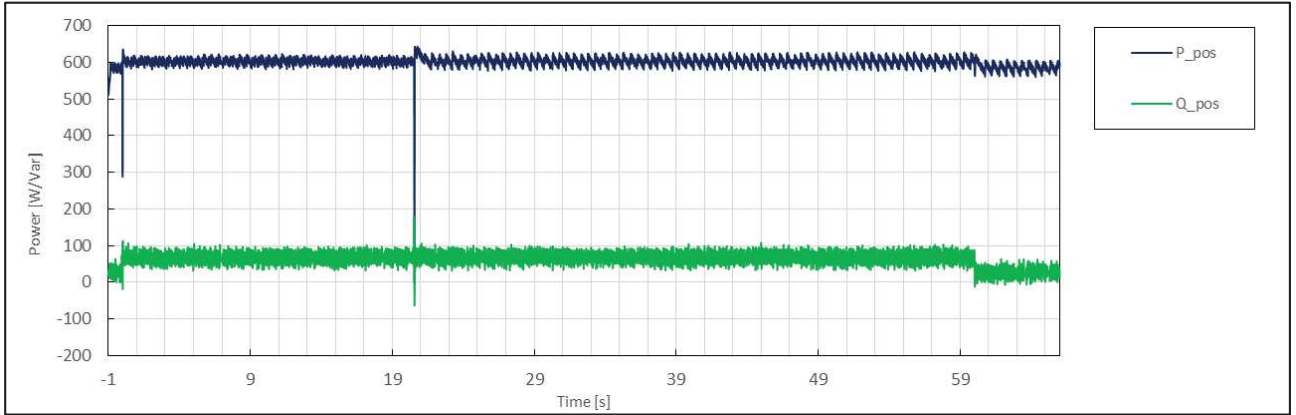

|                     | No. | Parameter  | Phase ref.      | Time ref.                       | unit       | Result        |
|---------------------|-----|--|-----------------|---------------------------------|------------|---------------|
| General Info.       | 0   | Test number  | --              | --                              | --         | 7.4           |
|                     | 1   | Date   | --              | --                              | dd.mm.yyyy | 3.1.2020      |
|                     | 2   | Time (start of test)                                   | --              | --                              | hh:mm:ss.f | 15:35:25      |
|                     | 3   | Fault type (phase)                                     | --              | --                              |            | 2-phase fault |
|                     | 4   | Setting voltage depth                                  | Line to line    | --                              | p.u.       | 1.15          |
|                     | 5   | Setting dip duration                                   |                 | --                              |            | 60019         |
|                     | 6   | Point of fault entry                                   | Total           | --                              | ms         | 0             |
|                     | 7   | Point of fault clearance                               | Total           | --                              | ms         | 60018         |
|                     | 8   | Fault duration in empty load test                      | Total           | --                              | ms         | 60019         |
|                     | 9   | Voltage depth/height in empty load test                | Total           | t1+100ms to t2 and t1-10s to t1 | p.u.       | 1.04          |
|                     | 10  |  | Pos.            |                                 | p.u.       | 1.07          |
| Before dip <t1      | 11  | Voltage  | Line to neutral | t1-100s to t1                   | p.u.       | 1.01          |
|                     | 12  | Current  | Pos.            | t1-500ms to t1-100ms            | p.u.       | 0.11          |
|                     | 13  | Active power   | Total           | t1-10s to t1                    | p.u.       | 0.33          |
|                     | 14  |  | Pos.            |                                 |            | 0.33          |
|                     | 15  | Reactive power   | Total           | t1-10s to t1                    | p.u.       | 0.04          |
|                     | 16  |  | Pos.            |                                 |            | 0.04          |
|                     | 17  | Cos $\varphi$  | --              | t1-10s to t1                    | --         | 0.994         |
| During dip t1 to t2 | 18  | Voltage  | Line to neutral | t1+100ms to t2-20ms             | p.u.       | 1.05          |
|                     | 19  | Line current   | Phase 1         | t1+60ms                         | p.u.       | N/A           |
|                     | 20  |  | Phase 2         |                                 |            | N/A           |
|                     | 21  |  | Phase 3         |                                 |            | 0.30          |
|                     | 22  | Line current   | Phase 1         | t1+100ms                        | p.u.       | N/A           |
|                     | 23  |  | Phase 2         |                                 |            | N/A           |
|                     | 24  |  | Phase 3         |                                 |            | 0.31          |
|                     | 25  | Active power   | Total           | t1+100ms to t2-20ms             | p.u.       | 0.33          |
|                     | 26  |  | Pos.            |                                 |            | 0.33          |
| After dip > t2      | 27  | Voltage  | Line to neutral | t2+3s to t2+10s                 | p.u.       | 1.01          |
|                     | 28  | Active power   | Total           | t2+3s to t2+10s                 | p.u.       | 0.33          |
|                     | 29  |  | Pos.            |                                 |            | 0.33          |
|                     | 39  | Active power rising time                               | Pos.            | --                              | s          | N/A           |
|                     | 31  | Reactive power   | Total           | t2+3s to t2+10s                 | p.u.       | 0.04          |
|                     | 32  |  | Pos.            |                                 |            | 0.04          |
|                     | 33  | Reactive power rising time                             | Pos.            | --                              | s          | N/A           |
|                     | 34  | PGU does not disconnect from grid till 60s after fault | --              | t2 to t2+60s                    | Yes / No   | No            |

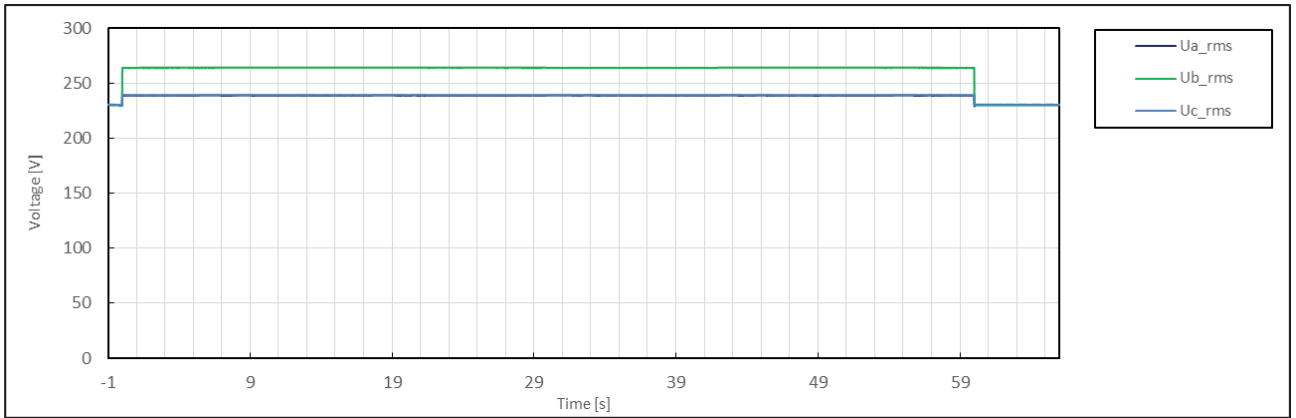
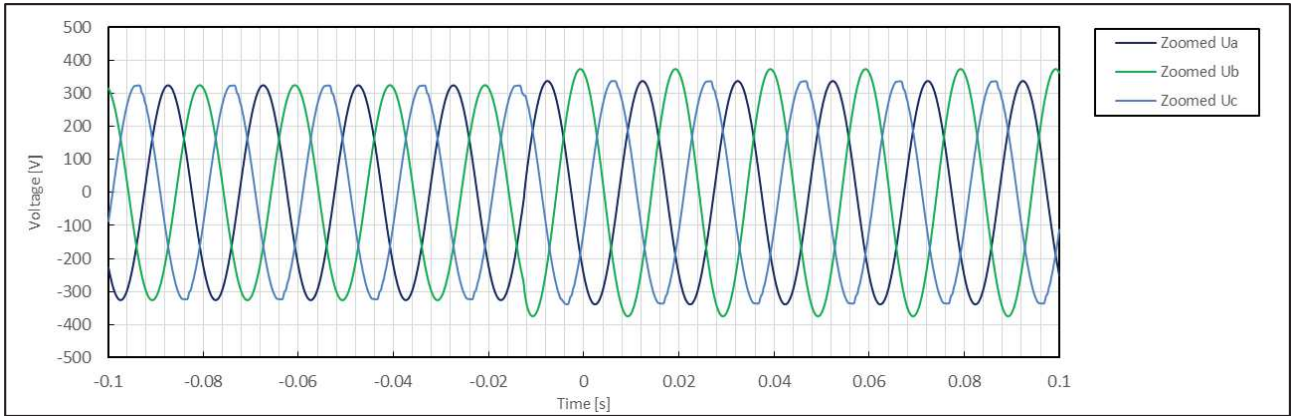
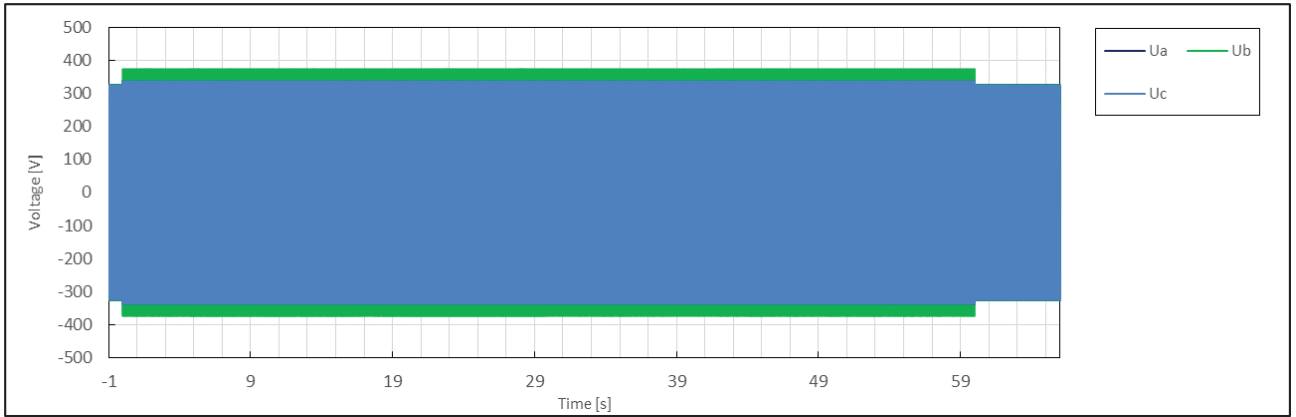

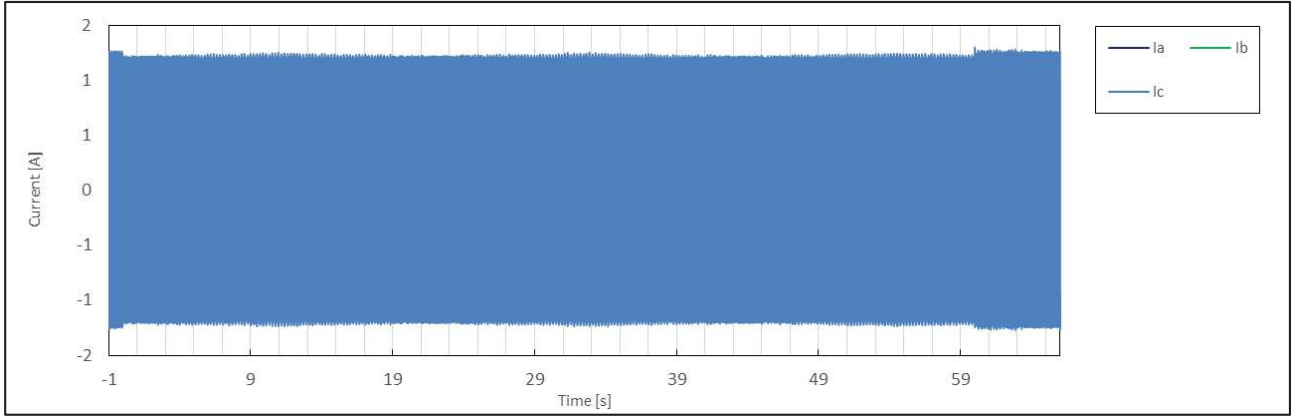
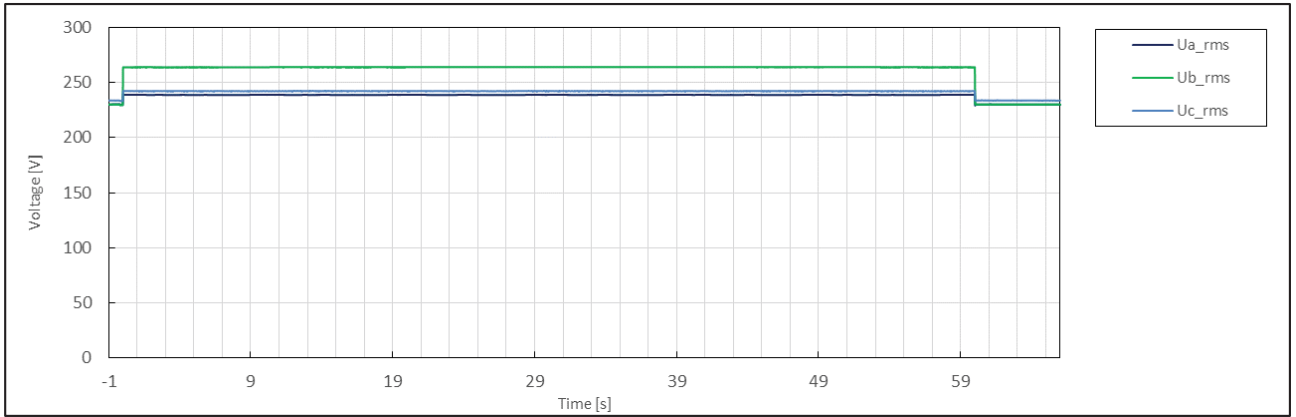
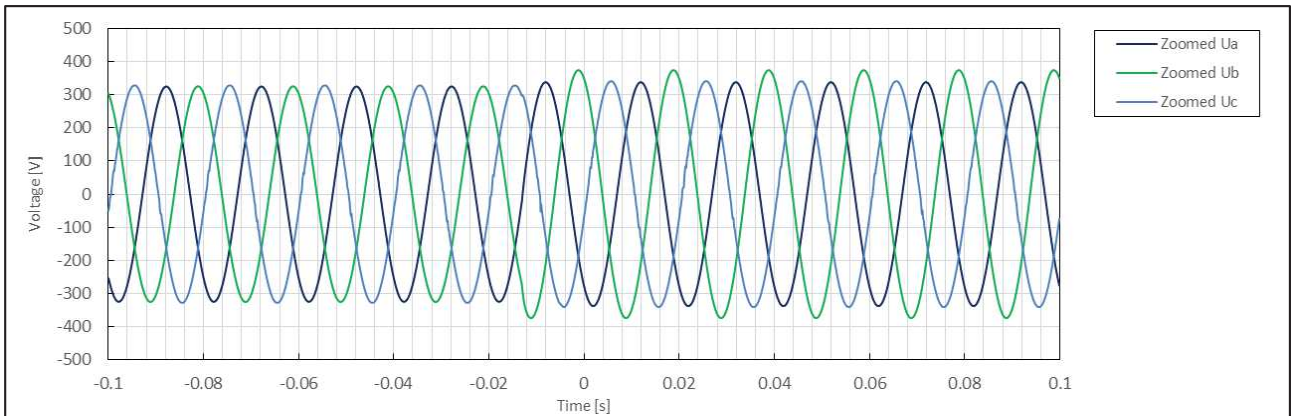
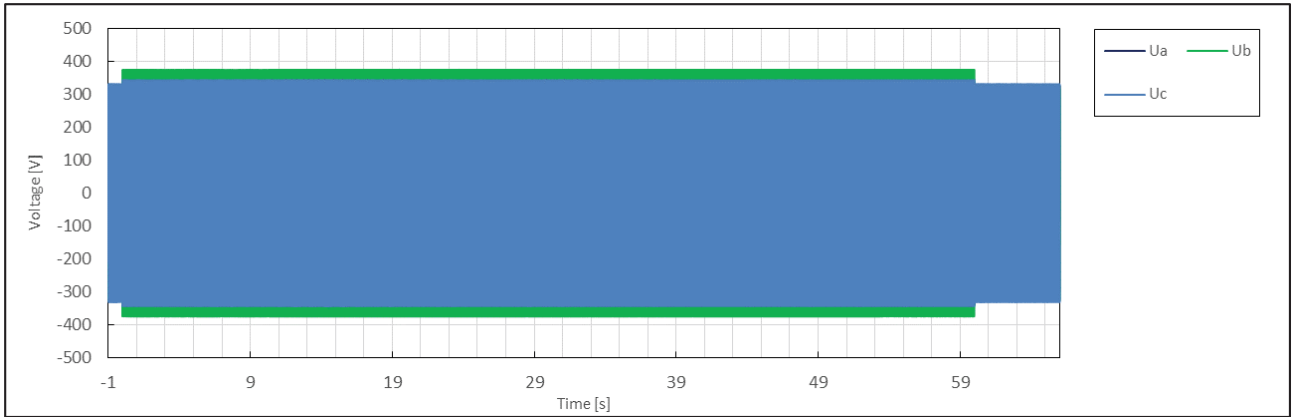

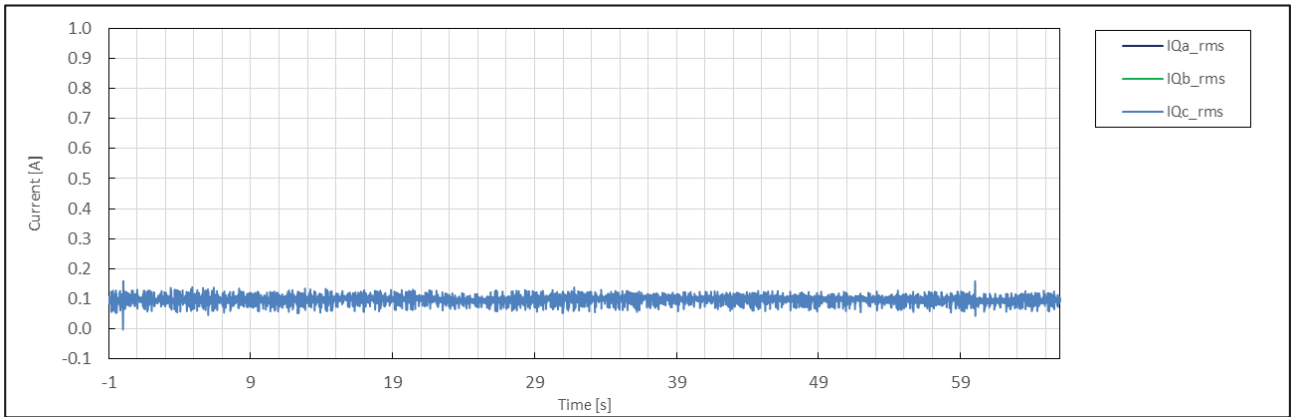
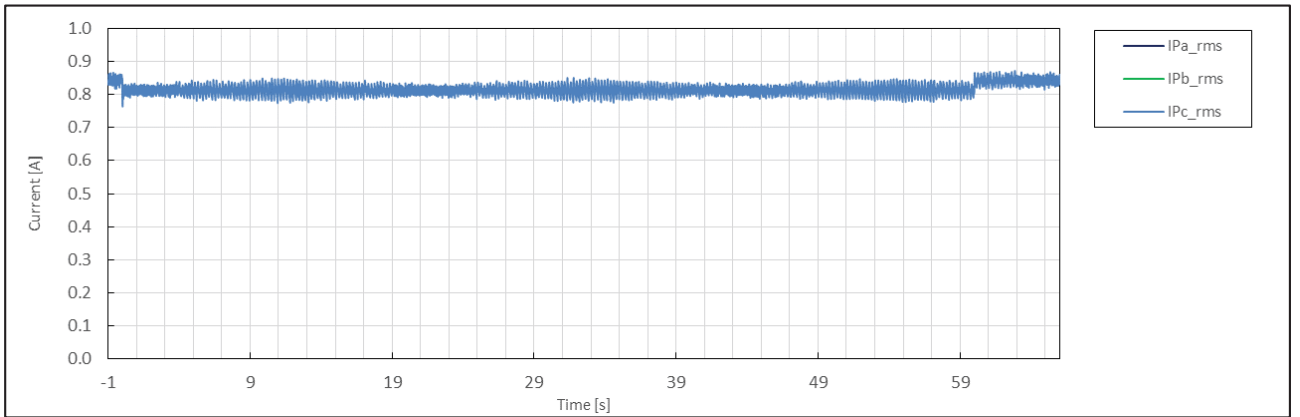
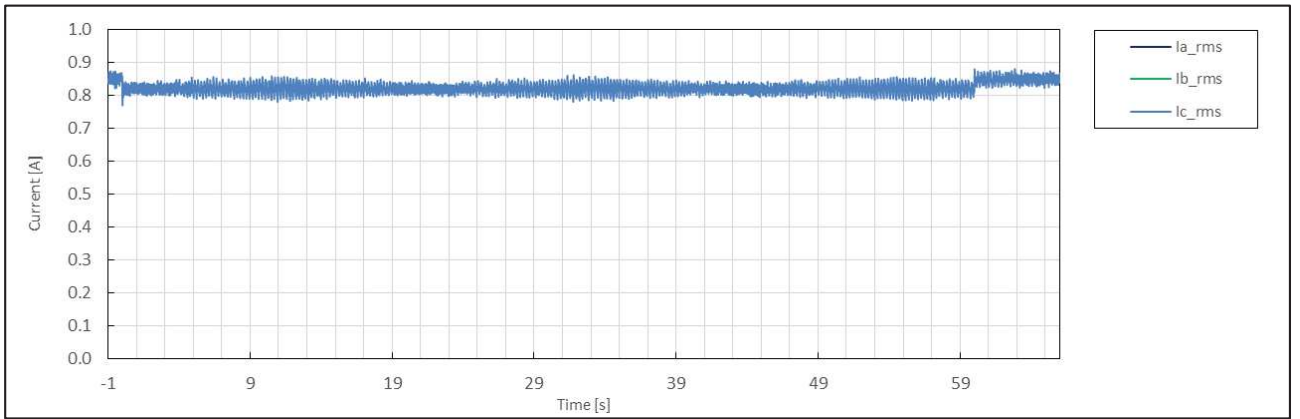
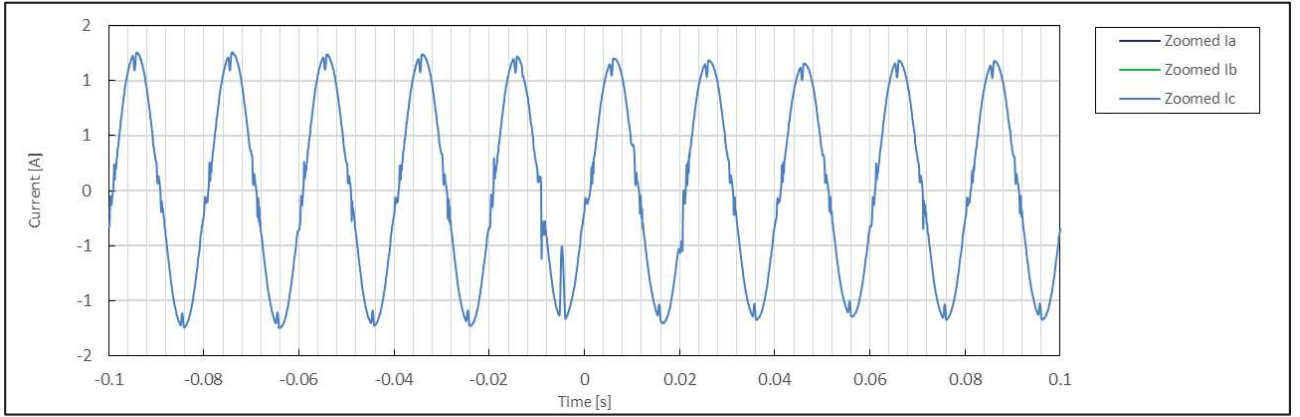



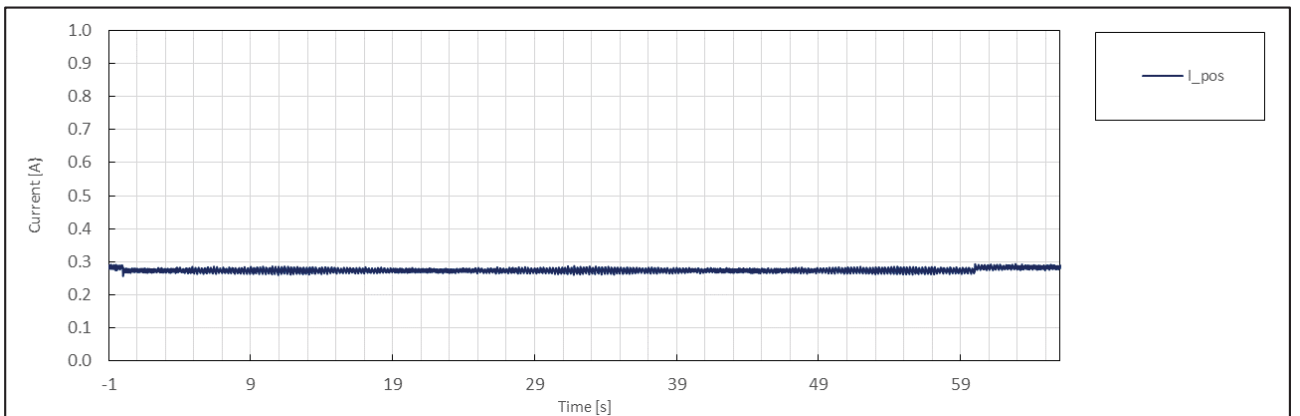
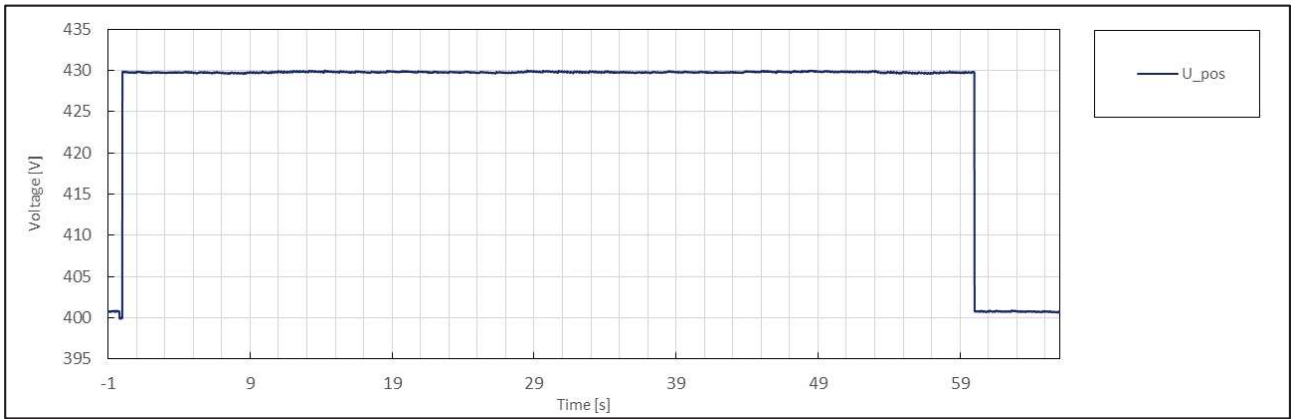
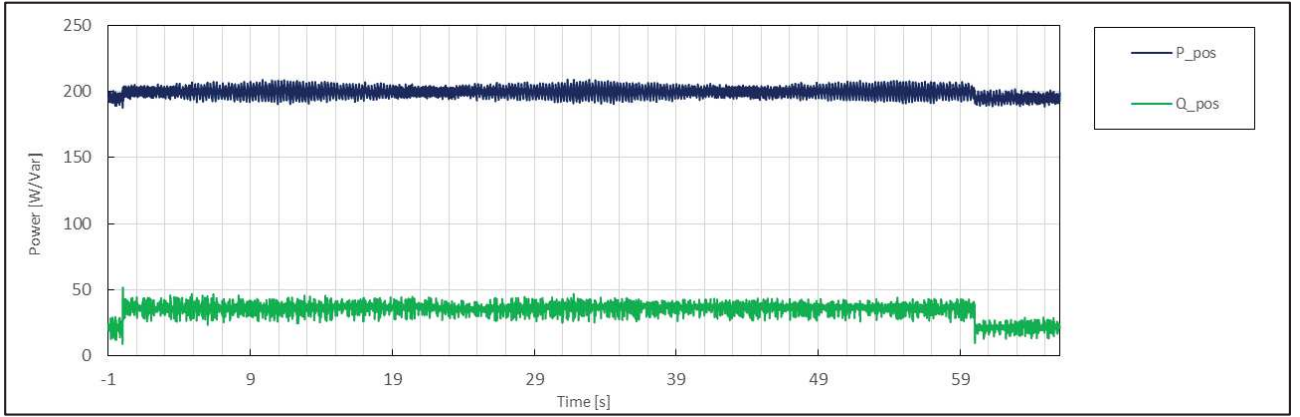

End of test report





PHOTO DOCUMENTATION

50336830 001

for

Grid-Connected PV Inverter

EVT300, EVT360, EVT560, EVT600, EVT660, EVT720,  
EVT1200

**Zhejiang Envertech Corporation Ltd**



This documentation consists of 8 pages (excluding this cover page)

Report Number: 50336830 001

Model: EVT300, EVT360, EVT560, EVT600, EVT660, EVT720, EVT1200



EVT300 / EVT360

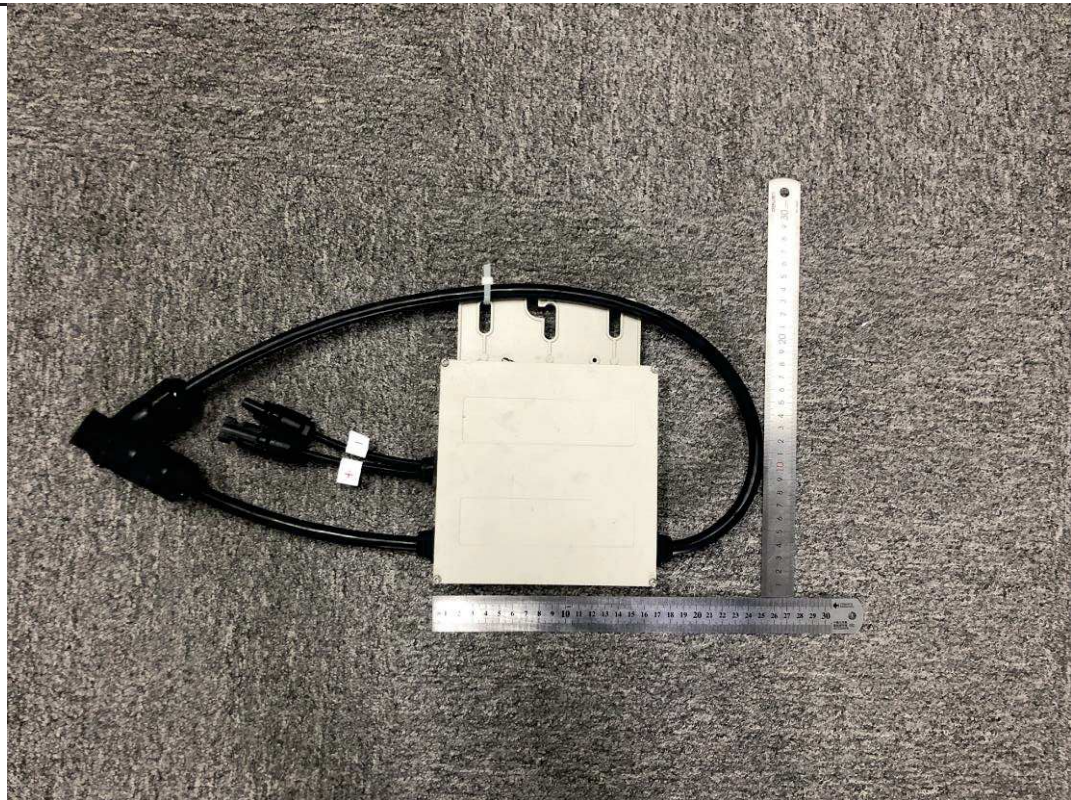

EVT300 / EVT360



Report Number: 50336830 001

Model: EVT300, EVT360, EVT560, EVT600, EVT660, EVT720, EVT1200

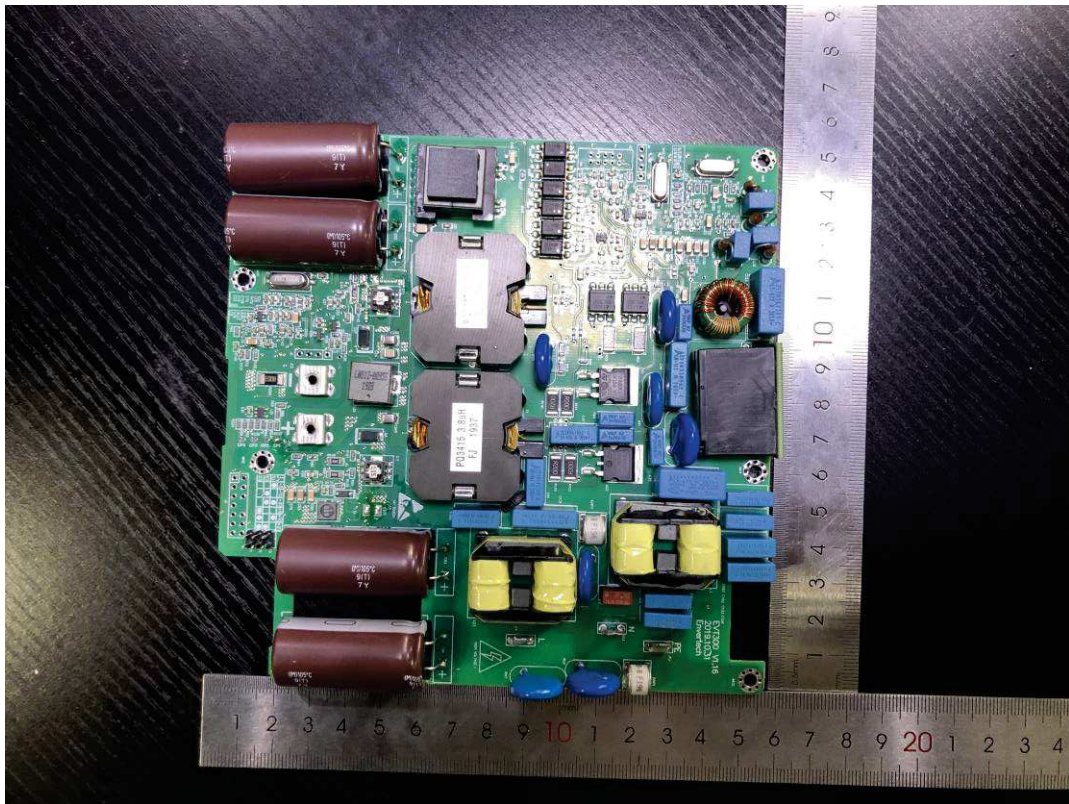

EVT300 / EVT360

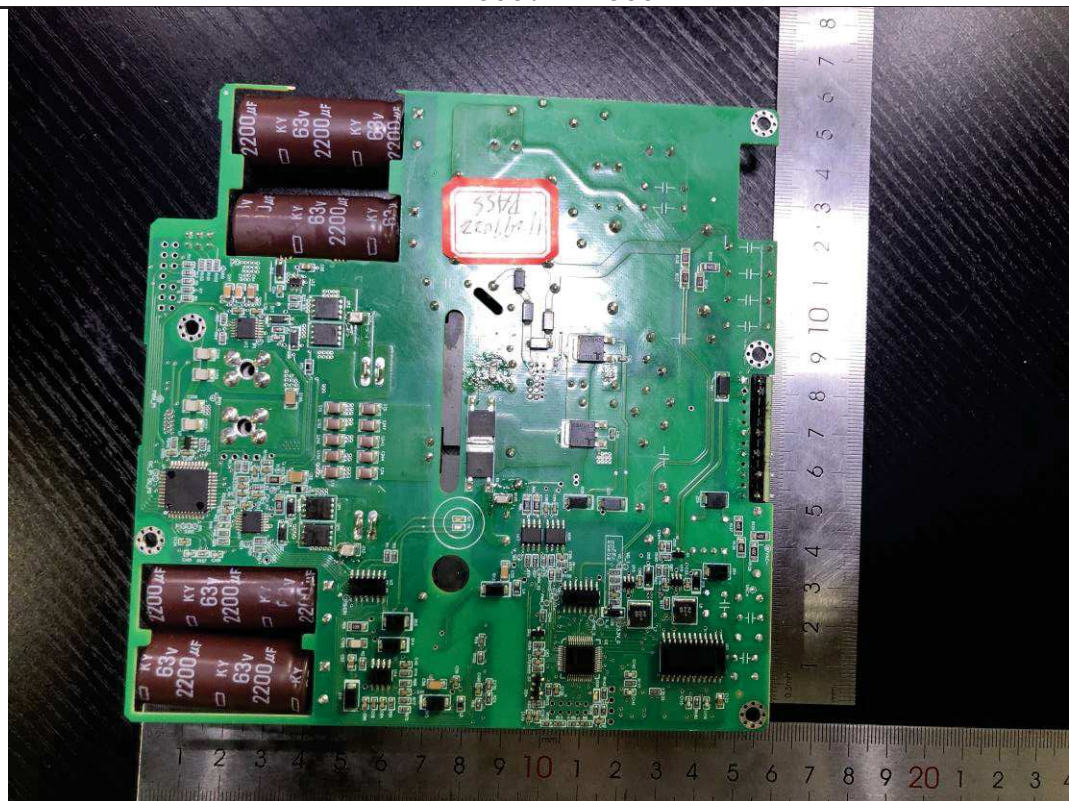

EVT300 / EVT360



**Report Number:** 50336830 001

**Model:** EVT300, EVT360, EVT560, EVT600, EVT660, EVT720, EVT1200

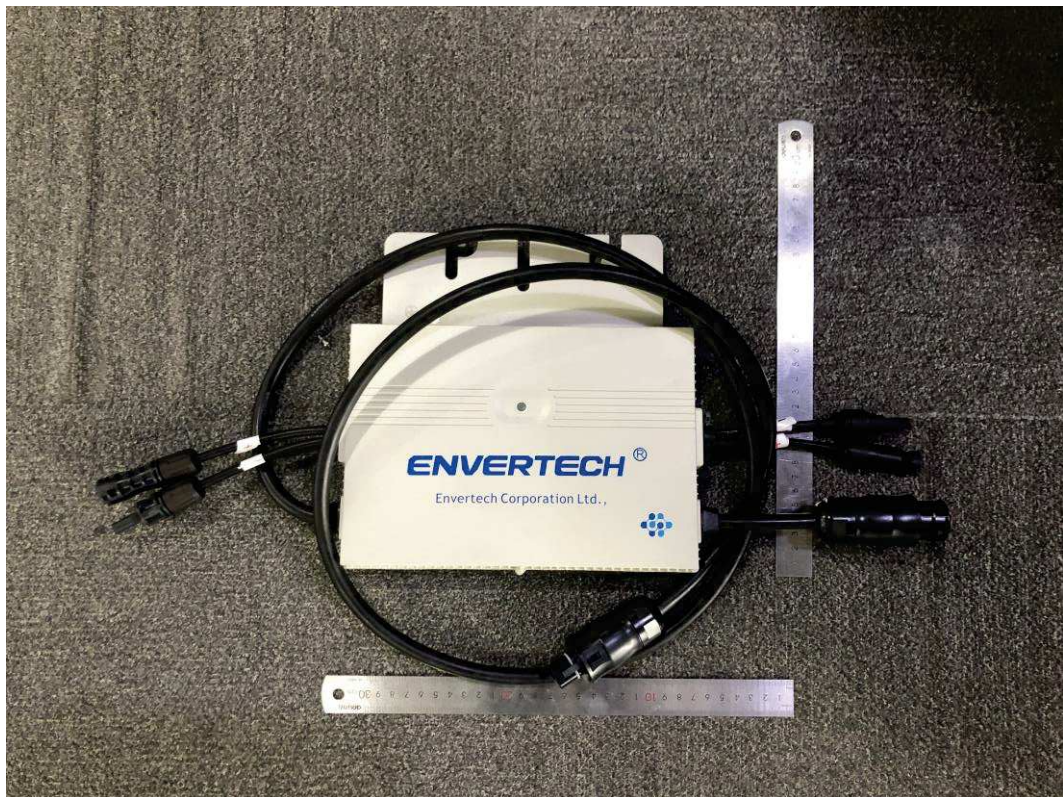

EVT560 / EVT600

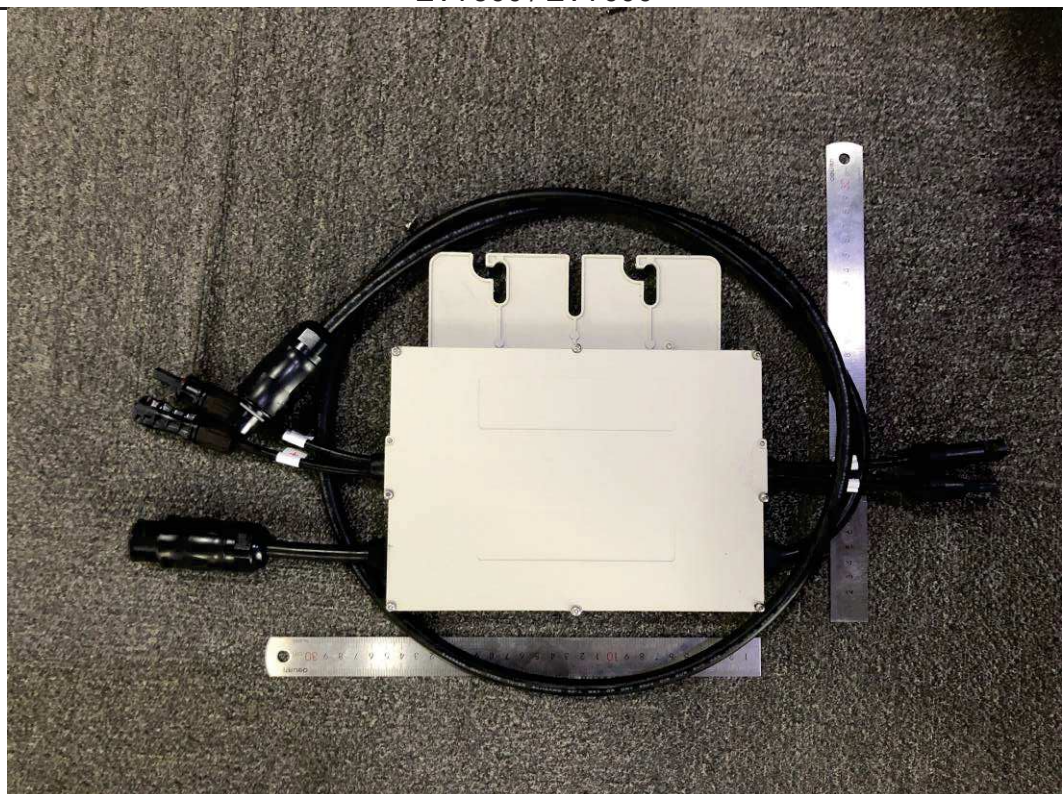

EVT560 / EVT600



Report Number: 50336830 001

Model: EVT300, EVT360, EVT560, EVT600, EVT660, EVT720, EVT1200

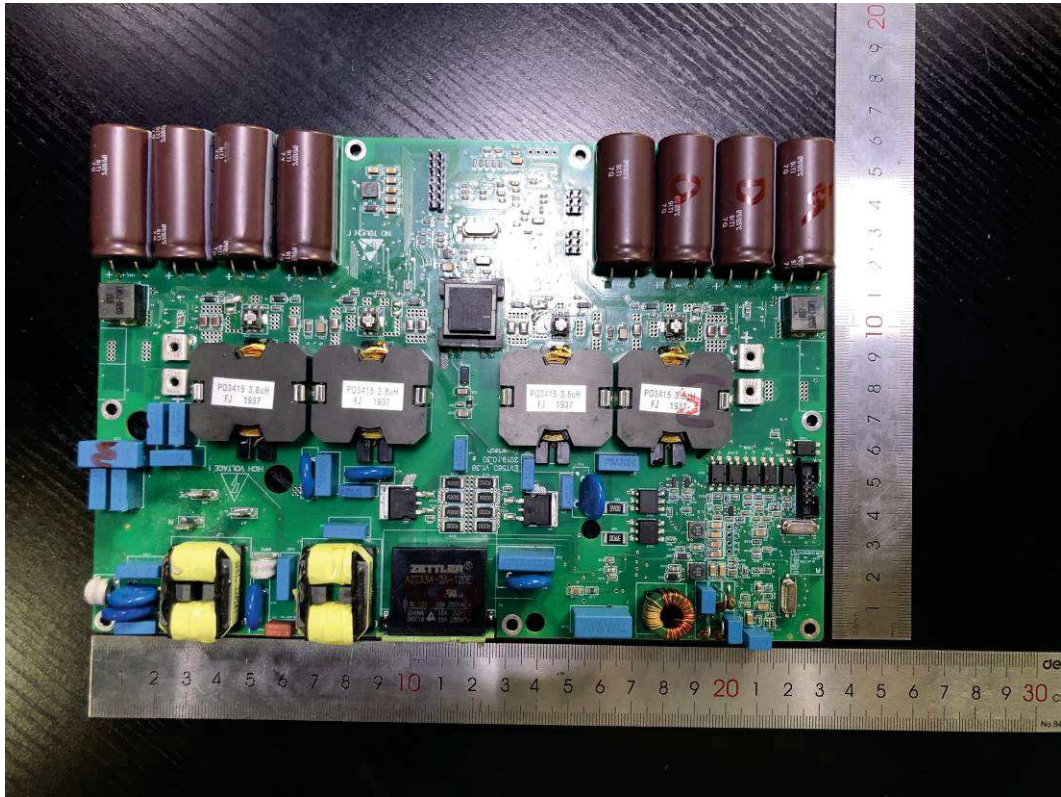

EVT560 / EVT600

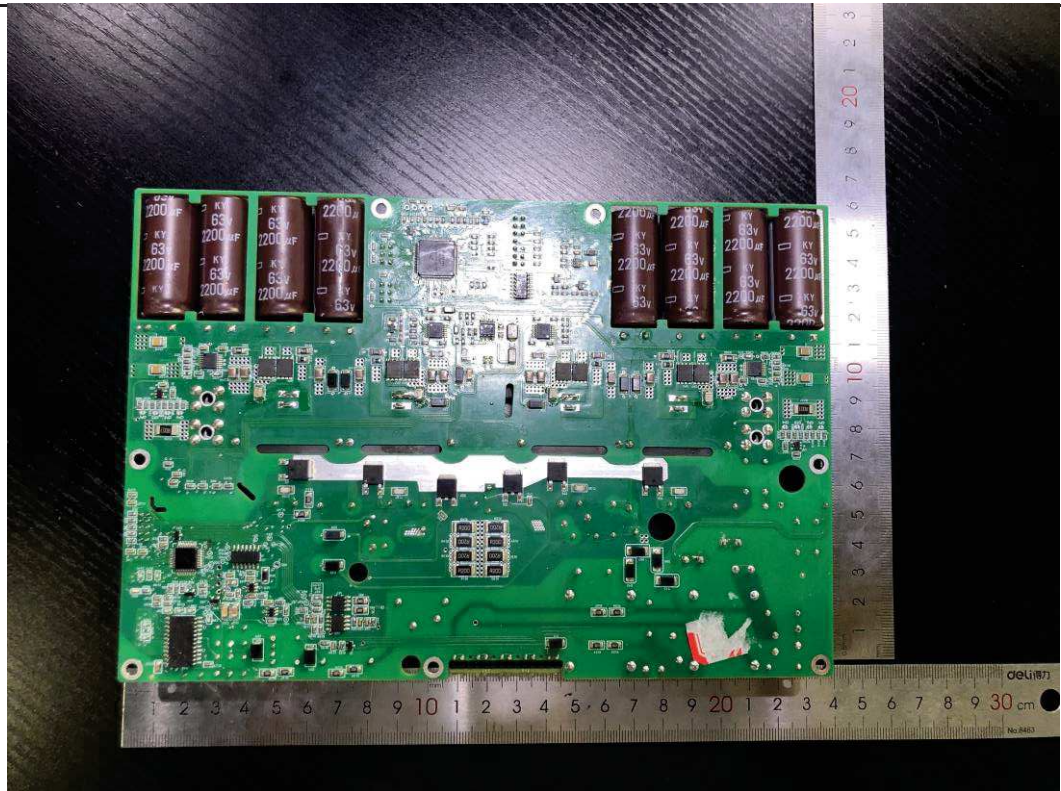

EVT560 / EVT600



Report Number: 50336830 001

Model: EVT300, EVT360, EVT560, EVT600, EVT660, EVT720, EVT1200



EVT660 / EVT720

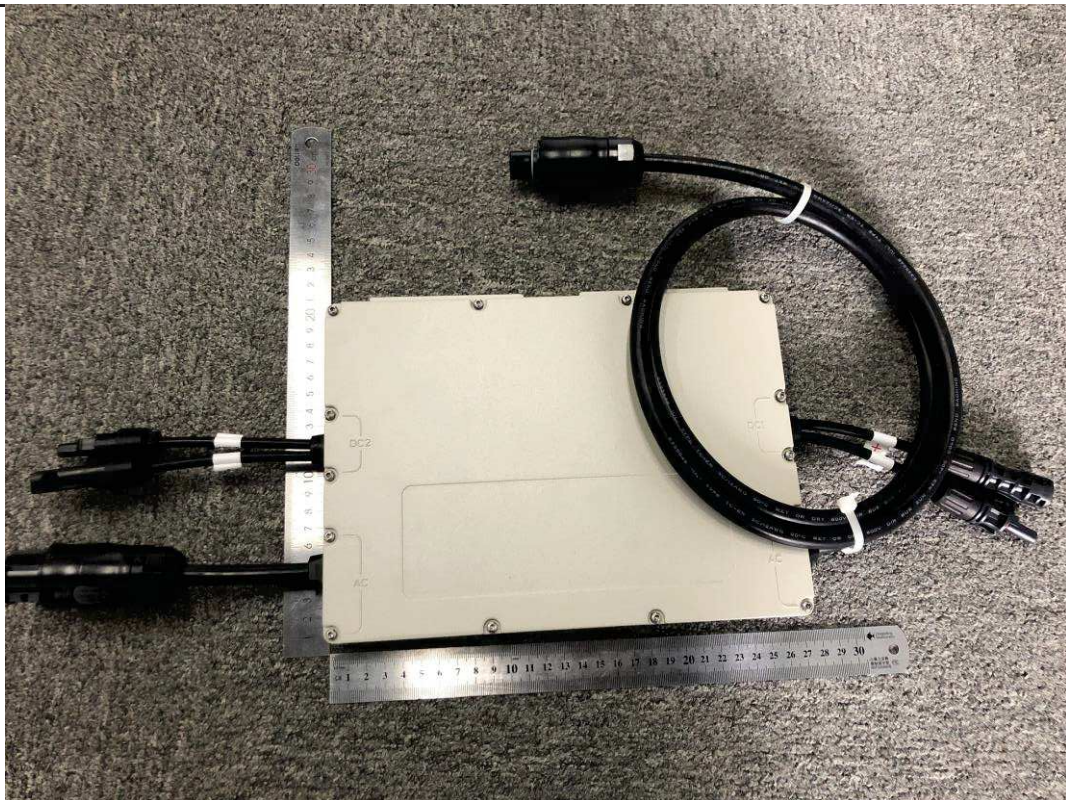

EVT660 / EVT720



Report Number: 50336830 001

Model: EVT300, EVT360, EVT560, EVT600, EVT660, EVT720, EVT1200

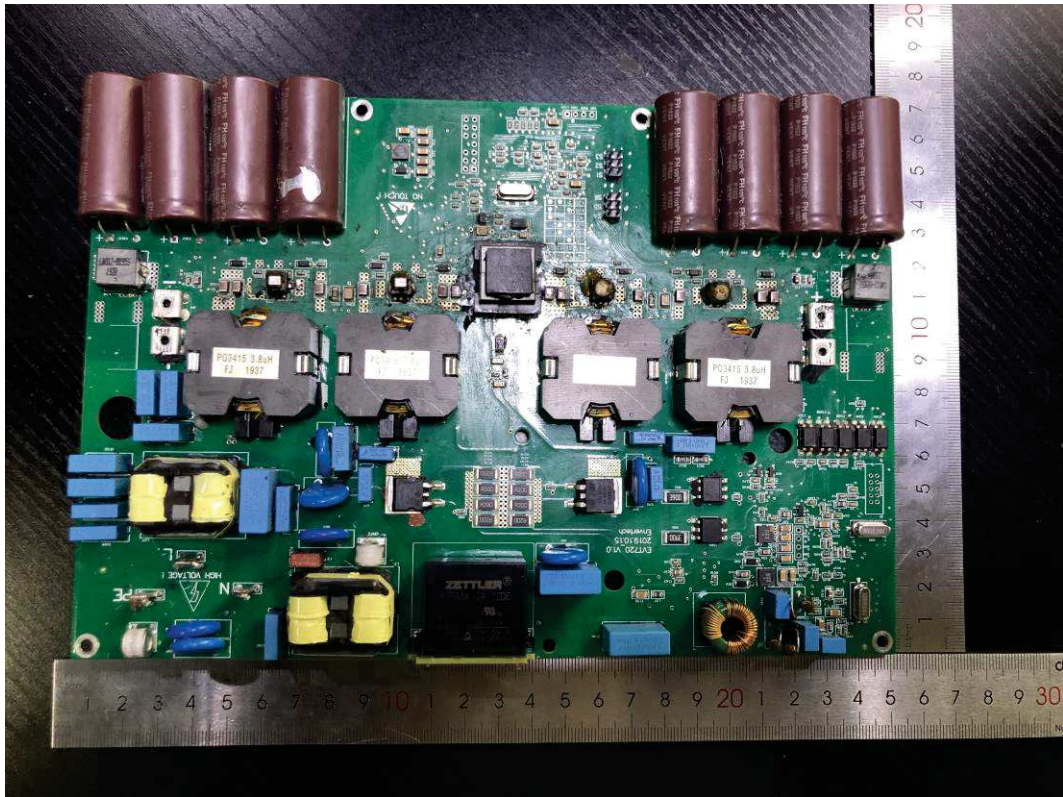

EVT660 / EVT720

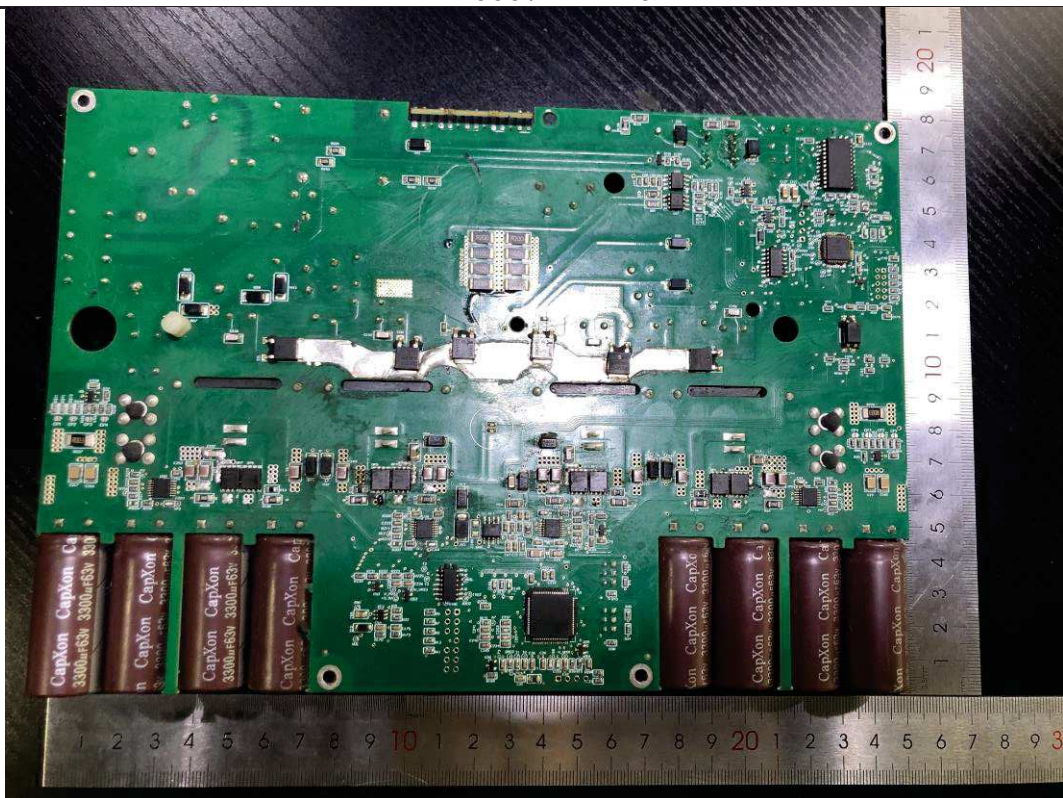

EVT660 / EVT720



Report Number: 50336830 001

Model: EVT300, EVT360, EVT560, EVT600, EVT660, EVT720, EVT1200

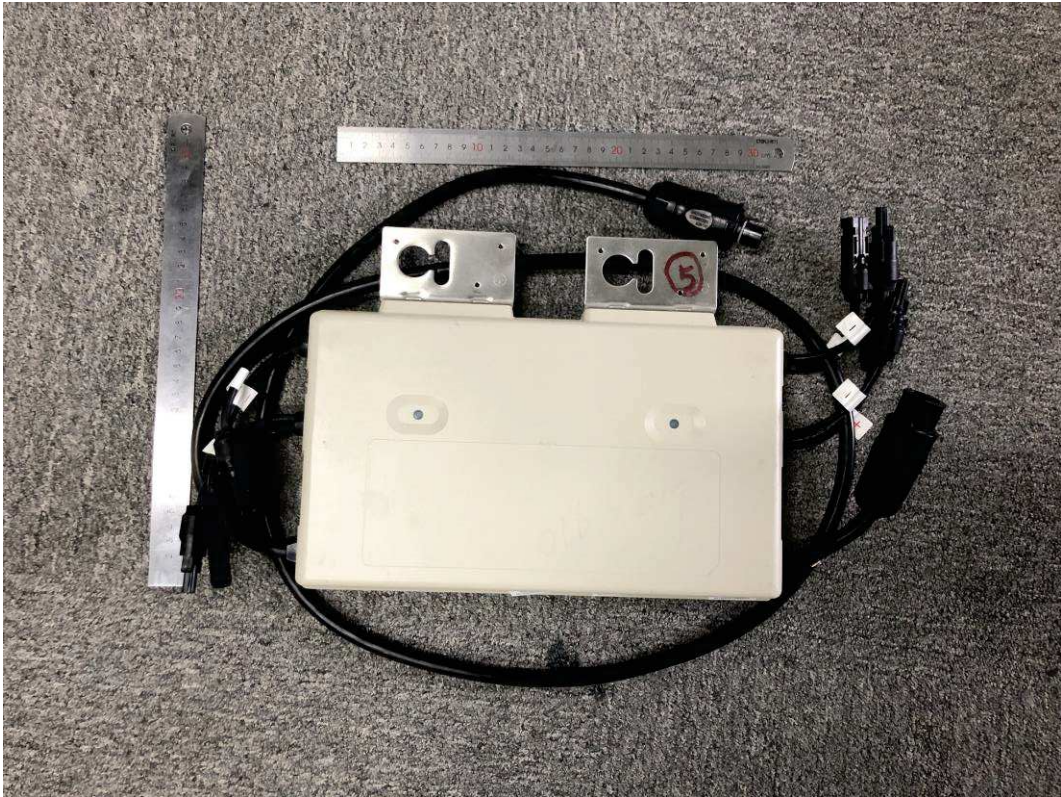

EVT1200

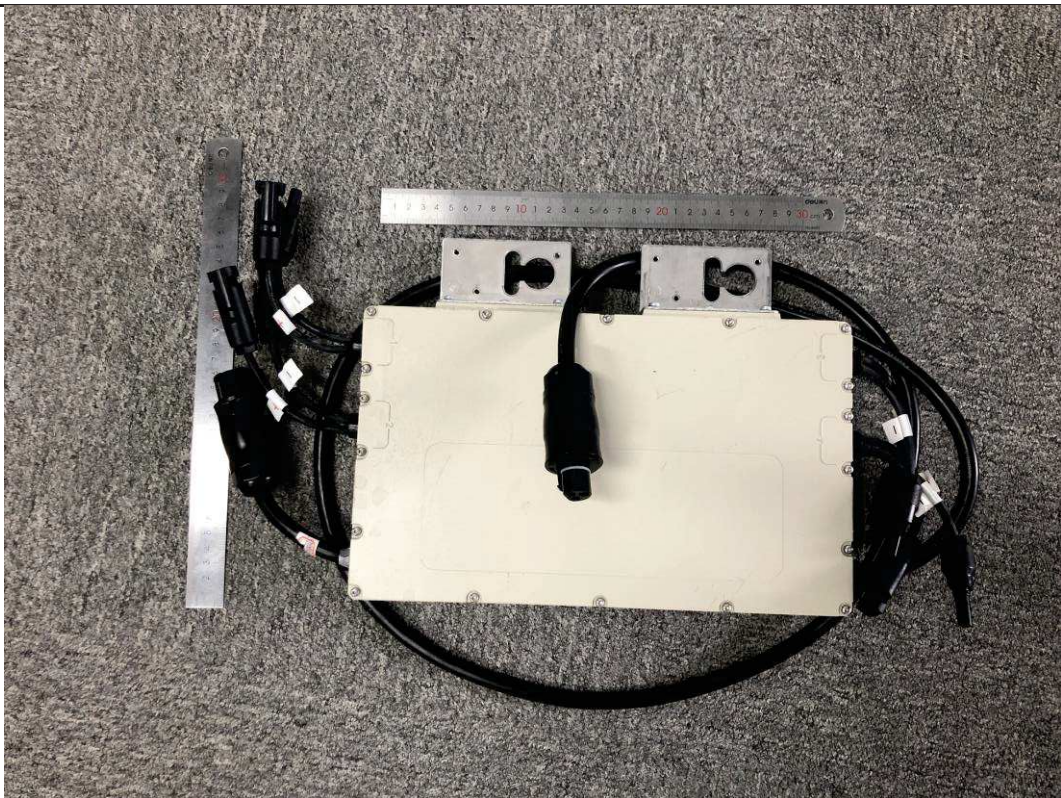

EVT1200



Report Number: 50336830 001

Model: EVT300, EVT360, EVT560, EVT600, EVT660, EVT720, EVT1200

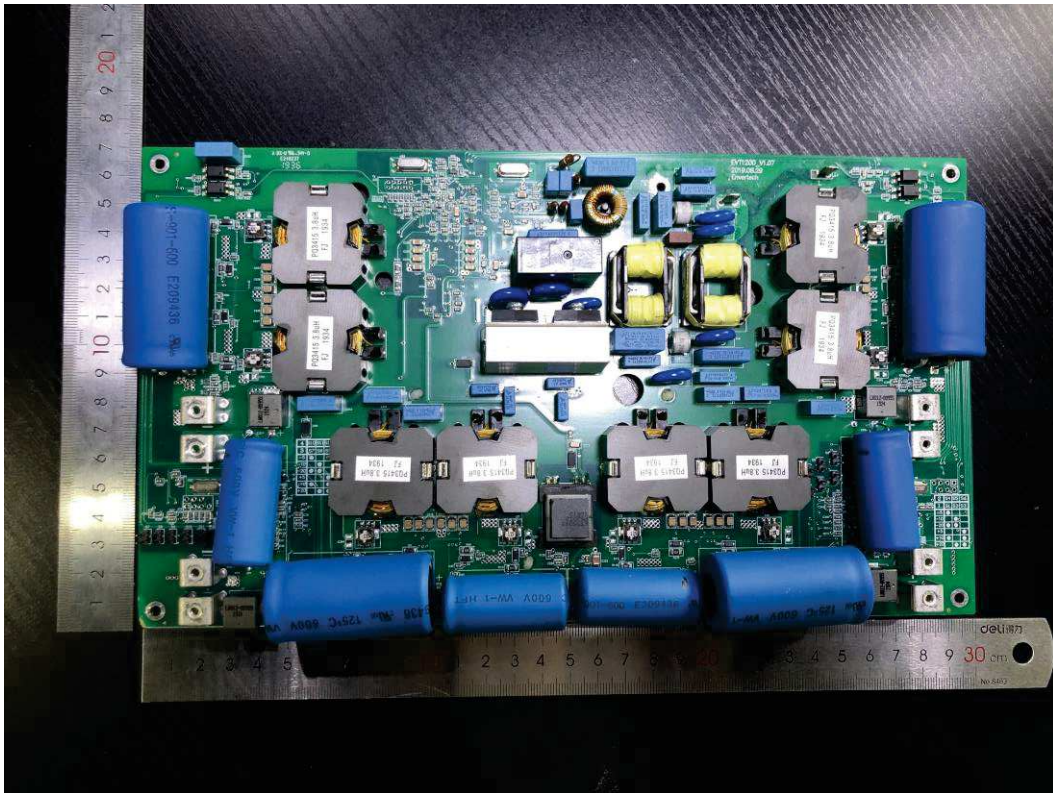

EVT1200

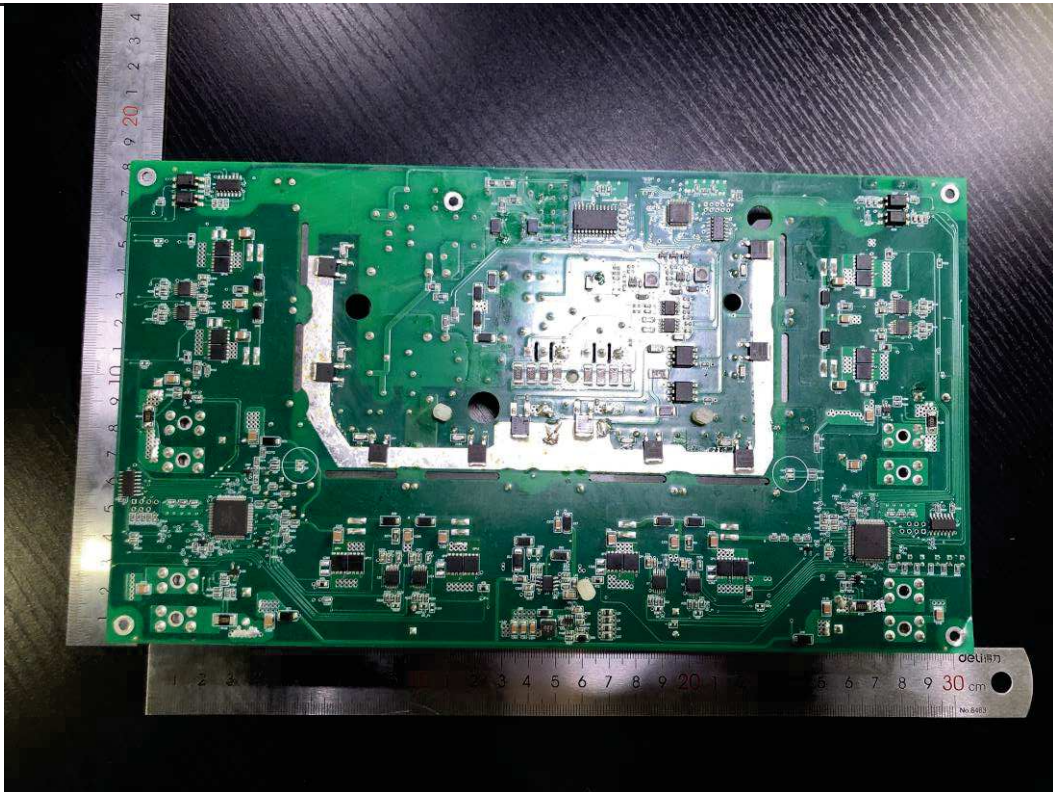

EVT1200